



**uni jet**

**ИБП Liebert APS (5-20 кВА) - руководство пользователя. Юниджет**

Постоянная ссылка на страницу: <https://www.uni-jet.com/catalog/ibp/online-ibp/liebert-aps/>



# Liebert® APS™

User Manual – 5-20kVA Modular UPS



---

---

---

# TABLE OF CONTENTS

<b>IMPORTANT SAFETY INSTRUCTIONS</b> .....	<b>1</b>
<b>SAVE THESE INSTRUCTIONS</b> .....	<b>1</b>
<b>GLOSSARY OF SYMBOLS</b> .....	<b>3</b>
<b>1.0 PRODUCT INTRODUCTION</b> .....	<b>4</b>
1.1 System Description .....	4
1.2 Features .....	8
1.3 Operating Principle .....	8
1.4 Operating Modes .....	10
1.5 Major Components .....	11
1.5.1 UPS Frame .....	11
1.5.2 User Interface Module .....	12
1.5.3 System Control Module and System Monitor Module .....	12
1.5.4 Power Module .....	13
1.5.5 Battery Module .....	13
1.5.6 Charger Module .....	14
1.5.7 External Battery Cabinet (EBC) .....	14
<b>2.0 INSTALLATION</b> .....	<b>15</b>
2.1 Unpacking Inspection .....	15
2.1.1 Installation Environment .....	15
2.1.2 Installation Tools .....	15
2.1.3 Installation Site .....	15
2.2 Unloading the UPS .....	16
2.3 Mechanical Installation .....	17
2.3.1 Tower Installation .....	17
2.3.2 Rack Installation .....	18
2.4 Module Installation .....	22
2.4.1 Installing Power Module, Battery Module and Charger Module .....	22
2.4.2 Install System Control and System Monitor Modules .....	23
2.5 Cable Connection .....	25
2.5.1 Transformer-Free UPS Cable Connection .....	25
2.5.2 Transformer-Based UPS Cable Connection .....	28
2.5.3 Transformer-Free UPS—Dual Inverter Frames .....	32
2.5.4 Connecting External Battery Cabinet .....	34
2.5.5 Connecting Integrated Power Output Distribution (POD) .....	36
2.5.6 Commissioning/Startup Procedures .....	36
<b>3.0 COMMUNICATION</b> .....	<b>38</b>
3.1 Liebert IntelliSlot Ports .....	38
3.2 Dry Contact Ports .....	39
3.3 REPO (Remote Emergency Power Off) .....	40

---

3.4	Long Run Time (LRT) Battery Temperature Probe Terminals . . . . .	41
3.5	USB Port . . . . .	41
3.6	Liebert MultiLink® . . . . .	42
3.7	LCD Port . . . . .	42
<b>4.0</b>	<b>OPERATION AND DISPLAY PANEL . . . . .</b>	<b>43</b>
4.1	Overview . . . . .	43
4.2	LCD Screen . . . . .	45
4.2.1	Startup Screen . . . . .	45
4.2.2	Main Screen . . . . .	45
4.2.3	Default Screen/Screen Saver . . . . .	50
4.3	LCD Screen Views . . . . .	50
4.3.1	AC Mains Screen . . . . .	50
4.3.2	Battery Screen . . . . .	51
4.3.3	Output Screen . . . . .	51
4.3.4	Load Screen . . . . .	52
4.3.5	UPS Information Screen . . . . .	52
4.3.6	Redundancy Screen . . . . .	53
4.3.7	Settings Screen . . . . .	54
4.4	Entering a Password . . . . .	55
4.5	Setting or Changing a Parameter Setting . . . . .	55
4.5.1	Battery Setting Screen . . . . .	56
4.5.2	Language Selection Screen . . . . .	56
4.5.3	Alarms Screen . . . . .	57
4.5.4	Records Screen . . . . .	57
4.5.5	Module Replacement Screen . . . . .	58
4.5.6	Prompt Window . . . . .	58
<b>5.0</b>	<b>TROUBLESHOOTING . . . . .</b>	<b>60</b>
5.1	Active Alarms . . . . .	60
5.2	Module Troubleshooting . . . . .	63
5.3	Module Replacement . . . . .	64
5.3.1	Removing Modules . . . . .	64
5.3.2	Replacing the User Interface Module . . . . .	66
<b>6.0</b>	<b>MAINTENANCE . . . . .</b>	<b>67</b>
6.1	Proper Care . . . . .	67
6.2	Scheduled Maintenance . . . . .	67
6.3	Cleaning Fan Filters . . . . .	67
6.3.1	Top Filter . . . . .	67
6.3.2	Bezel Filter . . . . .	68
6.3.3	Bottom Fan Filter—Transformer-Based Frames Only . . . . .	68
<b>7.0</b>	<b>SPECIFICATIONS . . . . .</b>	<b>69</b>
7.1	Estimated Battery Run Times . . . . .	72
7.1.1	Tables for UPS Where Model Number Digits 1-3 are AS1 or ASA . . . . .	72

---

7.2	Estimated Battery Run Times . . . . .	77
7.2.1	Tables for UPS Model Number Where Digits 1-3 are AS2 or ASB . . . . .	77
7.3	Estimated Battery Run Times . . . . .	81
7.3.1	Tables for UPS model number digits 1-3 are AS3 or ASC . . . . .	81
7.4	Estimated Battery Run Times . . . . .	85
7.4.1	Tables for UPS Model Number Where Digits 1-3 are AS4 or ASD . . . . .	85
7.5	Estimated Battery Run Times . . . . .	89
7.5.1	Tables for UPS Model Number Where Digits 1-3 are AS5 or ASE . . . . .	89

## FIGURES

Figure 1	16-bay transformer-free UPS . . . . .	5
Figure 2	10-bay transformer-free UPS . . . . .	5
Figure 3	12-bay transformer-based UPS . . . . .	6
Figure 4	16-bay transformer-based UPS . . . . .	7
Figure 5	Operating principle diagram . . . . .	9
Figure 6	UPS frames, bezels removed . . . . .	11
Figure 7	User interface module. . . . .	12
Figure 8	Liebert APS system control module and the system monitor module . . . . .	12
Figure 9	Liebert APS power module . . . . .	13
Figure 10	Battery module appearance . . . . .	13
Figure 11	Appearance of the charger module. . . . .	14
Figure 12	External battery cabinet. . . . .	14
Figure 13	Front and rear installation clearances . . . . .	15
Figure 14	Remove the mounting brackets . . . . .	16
Figure 15	Connect the ramp and remove UPS. . . . .	16
Figure 16	Adjust the leveling feet. . . . .	17
Figure 17	Installation position and drilling hole dimensions for stationary mounting. . . . .	17
Figure 18	Install cage nuts . . . . .	18
Figure 19	Install the tray . . . . .	18
Figure 20	Install the guide rails. . . . .	19
Figure 21	Install the brackets . . . . .	19
Figure 22	Push the UPS frame into the rack . . . . .	20
Figure 23	Fix the UPS frame . . . . .	20
Figure 24	Install the metal plate . . . . .	21
Figure 25	Installation completed . . . . .	21
Figure 26	Insert the power module, battery module and charger module . . . . .	22
Figure 27	Lever and fastener . . . . .	23
Figure 28	Remove large plastic bezel and user interface module . . . . .	23
Figure 29	Insert the System Control and System Monitor module . . . . .	24
Figure 30	Lever and fastener on System Control and System Monitor Module . . . . .	24
Figure 31	Knockouts . . . . .	26
Figure 32	Connection in single-phase input. . . . .	26
Figure 33	Connection in 3-phase input. . . . .	27
Figure 34	Setting bypass voltage jumper (default: 208VAC) . . . . .	29
Figure 35	Setting bypass voltage jumper (200/220/230/240VAC) . . . . .	29
Figure 36	Configuring the neutral/earth jumper . . . . .	30
Figure 37	Knockouts . . . . .	30
Figure 38	Connection method . . . . .	31
Figure 39	Knockouts . . . . .	32

---

Figure 40	Secure cables on cable bridges . . . . .	33
Figure 41	Wiring connections . . . . .	33
Figure 42	Connecting external battery cabinet to a transformer-free UPS . . . . .	34
Figure 43	Connecting external battery cabinet (transformer-based UPS) . . . . .	35
Figure 44	Battery screen . . . . .	35
Figure 45	Liebert IntelliSlot communication port location . . . . .	38
Figure 46	Pin layout of the dry contacts . . . . .	39
Figure 47	REPO connector pin layout . . . . .	40
Figure 48	REPO switch connections . . . . .	40
Figure 49	Pin layout of the temperature sensor terminal . . . . .	41
Figure 50	LCD port . . . . .	42
Figure 51	Operation and display panel . . . . .	43
Figure 52	User interface module layout . . . . .	44
Figure 53	Startup screen . . . . .	45
Figure 54	Main screen . . . . .	45
Figure 55	Default screen/screen saver . . . . .	50
Figure 56	Mains screen . . . . .	50
Figure 57	Battery screens . . . . .	51
Figure 58	Output screen . . . . .	51
Figure 59	Load screen . . . . .	52
Figure 60	UPS info screen . . . . .	52
Figure 61	Redundancy screen . . . . .	53
Figure 62	Settings screens . . . . .	54
Figure 63	Settings screens, ( <i>continued</i> ) . . . . .	55
Figure 64	Battery settings screens . . . . .	56
Figure 65	Language selection screen . . . . .	56
Figure 66	Alarms screen . . . . .	57
Figure 67	Records screen . . . . .	57
Figure 68	Module replacement screen . . . . .	58
Figure 69	Example of prompt window . . . . .	58
Figure 70	Module LED location . . . . .	63
Figure 71	Lever and fastener . . . . .	64
Figure 72	Pull out a battery module, a power module or a charge module . . . . .	65
Figure 73	Replacing the user interface module . . . . .	66
Figure 74	Replace/clean the top filter . . . . .	67
Figure 75	Replace/clean the bezel filter . . . . .	68
Figure 76	Replace/clean the bottom fan filter . . . . .	68

## TABLES

Table 1	Frame designation . . . . .	4
Table 2	Cable connection method reference . . . . .	25
Table 3	Input cable selection list—60Hz . . . . .	25
Table 4	Input cable selection list—50Hz . . . . .	25
Table 5	Input cable selection for Transformer-based frames (60 Hz) . . . . .	28
Table 6	Input cable selection for Transformer-based frames (50 Hz) . . . . .	28
Table 7	Configuration list for output cables . . . . .	31
Table 8	Maximum load capacity of the output winding . . . . .	31
Table 9	Input cable selection for Transformer-free Dual Inverter frames(50/60 Hz) . . . . .	32
Table 10	Input cable selection for Transformer-free Dual Inverter frames(50/60 Hz) . . . . .	32
Table 11	EBC DIP switch settings . . . . .	35

---

Table 12	Pin definition of dry contact port . . . . .	39
Table 13	Pin definition of the REPO dry contact . . . . .	40
Table 14	Pin definition of the temperature sensor terminal . . . . .	41
Table 15	LED descriptions . . . . .	43
Table 16	Audible alarm descriptions . . . . .	44
Table 17	Control buttons functions . . . . .	44
Table 18	Function descriptions of menu button . . . . .	44
Table 19	Item description of system information window . . . . .	45
Table 20	Item description of menu window and data window . . . . .	46
Table 21	Function descriptions of menu buttons . . . . .	49
Table 22	Information and actions required for the prompt window . . . . .	59
Table 23	Alarm message list . . . . .	60
Table 24	Descriptions of module LEDs . . . . .	63
Table 25	Liebert APS specifications . . . . .	69
Table 26	Rated input voltage range (Unit: VAC) . . . . .	70
Table 27	Specifications of Liebert APS external battery cabinet . . . . .	71
Table 28	10-bay, single-phase, no transformer unit Type N (& UPS model number digit 6 = N) . . . . .	72
Table 29	10-bay, single-phase, no transformer unit Type N (& UPS model number digit 6 = N) . . . . .	73
Table 30	10-bay, single-phase, no transformer unit Type R (& UPS model number digit 6 = R) . . . . .	74
Table 31	10-bay, single-phase, no transformer unit Type B (& UPS model number digit 6 = B) . . . . .	75
Table 32	10-bay, single-phase, no transformer unit Type F (& UPS model number digit 6 = F) . . . . .	76
Table 33	16-bay, single-phase, no transformer unit Type N (& UPS model number digit 6 = N) . . . . .	77
Table 34	16-bay, single-phase, no transformer unit Type R (& UPS model number digit 6 = R) . . . . .	78
Table 35	16-bay, single-phase, no transformer unit Type B (& UPS model number digit 6 = B) . . . . .	79
Table 36	16-bay, single-phase, no transformer unit Type F (& UPS model number digit 6 = F) . . . . .	80
Table 37	12-bay, single-phase, transformer-based unit Type N (& UPS model number 6 = N) . . . . .	81
Table 38	12-bay, single-phase, transformer-based unit Type R (& UPS model number 6 = R) . . . . .	82
Table 39	12-bay, single-phase, transformer-based unit Type B (& UPS model number 6 = B) . . . . .	83
Table 40	12-bay, single-phase, transformer-based unit Type F (& UPS model number 6 = F) . . . . .	84
Table 41	16-bay, single-phase, transformer-based unit Type N (& UPS model number 6 = N) . . . . .	85
Table 42	16-bay, single-phase, transformer-based unit Type R (& UPS model number 6 = R) . . . . .	86
Table 43	16-bay, single-phase, transformer-based unit Type B (& UPS model number 6 = B) . . . . .	87
Table 44	16-bay, single-phase, transformer-based unit Type F (& UPS model number 6 = F) . . . . .	88
Table 45	10-bay, two-phase, no transformer unit Type N (& UPS model number 6 = N) . . . . .	89
Table 46	10-bay, two-phase, no transformer unit Type R (& UPS model number 6 = R) . . . . .	90
Table 47	10-bay, two-phase, no transformer unit Type B (& UPS model number 6 = B) . . . . .	91
Table 48	10-bay, two-phase, no transformer unit Type F (& UPS model number 6 = F) . . . . .	92

---



---

---

## IMPORTANT SAFETY INSTRUCTIONS

---

### SAVE THESE INSTRUCTIONS

This manual contains important safety instructions. Read all safety, installation and operating instructions before operating the Liebert® APS™ modular UPS system. Adhere to all warnings on the unit and in this manual. Follow all operating and user instructions. Individuals must fully understand this equipment to install and operate it.

This product is designed for commercial/industrial use only. It is not intended for use with life support or other designated critical devices. Maximum load must not exceed that shown on the rating label. Install and operate the unit only in an indoor clean environment, free from conductive contaminants, moisture, flammable liquids, gases and corrosive substances. This Liebert APS contains no user serviceable parts other than the user replaceable modules. Refer all faults to your local dealer, local Emerson Network Power representative or the Emerson Network Power Liebert Service Group.

The Liebert APS UPS system is designed for use on a properly earthed (grounded) "TN" electrical supply, for installation by qualified personnel. A qualified electrician must review and approve customer supplied wiring, circuit breakers, and intended loads and verify correct input, output, and earth connections to ensure compliance with the technical standards and local electrical codes of practice. Installation instructions and warning notices are found in this manual.



### WARNING

Risk of electric shock. Can cause equipment damage, injury and death.

The battery can present a risk of electrical shock and high short circuit current. The following precautions should be observed before replacing the battery pack:

- Wear rubber gloves and boots
- Remove rings, watches and other metal objects.
- Use tools with insulated handles.
- Do not lay tools or other metal objects on the batteries.
- If the battery kit is damaged in any way or shows signs of leakage, contact your local Emerson representative immediately.
- Do not dispose of batteries in a fire. The batteries may explode.
- Handle, transport and recycle batteries in accordance with local regulations.



### WARNING

Risk of electric shock and fire. Can cause equipment damage, injury and death.

Although the Liebert APS UPS has been designed and manufactured to ensure personal safety, improper use can result in electrical shock or fire. To ensure safety, observe the following precautions:

- Clean the UPS with a dry cloth. Do not use liquid or aerosol cleaners.
- Never block or insert any objects into the ventilation holes or other openings of the UPS.
- Do not place the Liebert APS where it might be damaged.



### WARNING

Risk of electric shock. Can cause equipment damage, injury and death.

This UPS contains no user-serviceable parts except for the user-replaceable module assemblies. The UPS On/Off push button does not electrically isolate internal parts.

All service and maintenance operations must be performed by properly trained and qualified personnel. Under no circumstances should unqualified or unauthorized personnel attempt to gain access to the internal portions of the Liebert APS.

**ELECTROMAGNETIC COMPATIBILITY**—The Liebert APS complies with the limits of Category C2, pursuant to IEC/EN/AS 62040-2, and for a Class A digital device, pursuant to Part 15 of FCC rules. Operation is subject to the following conditions:

- The output cables shall be no longer than 10m (32ft).
- This device may not cause harmful interference.
- This device must accept any interference received, including interference that may cause undesired operation. Operating this device in a residential area is likely to cause harmful interference that users must correct at their own expense.

The Liebert APS complies with the requirements of EMC Directive 2004/108/EC and the published technical standards. Continued compliance requires installation in accordance with these instructions and use of accessories approved by Emerson.

Operate the UPS in an indoor environment only in an ambient temperature range of 0-40°C (32-104°F). Install it in a clean environment, free from moisture, flammable liquids, gases and corrosive substances.

Do not continue to use the UPS if the front panel indications are not in accordance with these operating instructions or the UPS performance alters in use. Refer all faults to your local service dealer.

Servicing of batteries should be performed or supervised by personnel knowledgeable of batteries and the required precautions. Keep unauthorized personnel away from the batteries. Proper disposal of batteries is required. Refer to your local laws and regulations for disposal requirements.

Never block or insert any object into the ventilation holes or other openings.

DO NOT CONNECT equipment that could overload the UPS or demand DC current from the UPS, for example: electric drills, vacuum cleaners, laser printers, hair dryers or any appliance using half wave rectification.

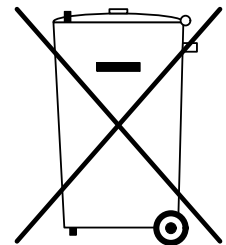
Storing magnetic media on top of the UPS may result in data loss or corruption. Turn Off and isolate the UPS before cleaning it. Use only a soft dry cloth; never use liquid or aerosol cleaners.

### **Information for the Protection of the Environment**

**UPS SERVICING**—This UPS makes use of components dangerous for the environment (electronic cards, electronic components). The components removed must be taken to specialized collection and disposal centers.

**NOTICE TO EUROPEAN UNION CUSTOMERS: DISPOSAL OF OLD APPLIANCES**—This product has been supplied from an environmentally aware manufacturer that complies with the Waste Electrical and Electronic Equipment (WEEE) Directive 2002/96/CE.















The crossed-out trash bin symbol at right is placed on this product to encourage users to recycle components and units whenever possible. Please be environmentally responsible and recycle this product through your recycling facility at its end of life. Do not dispose of this product as unsorted municipal waste. Follow local municipal waste ordinances for proper disposal provisions to reduce the environmental impact of waste electrical and electronic equipment (WEEE).



For information regarding the scrapping/disposal of this equipment, please browse [www.eu.emersonnetworkpower.com](http://www.eu.emersonnetworkpower.com) (Products section or Contact us section) or call Emerson's worldwide technical support.

- Toll Free Outside of North America: 00 80011554499
- Toll Number Based in Italy: +39 0298250222
- Toll Free in North America: 1-800-LIEBERT (1-800-543 2378)

## GLOSSARY OF SYMBOLS

	Risk of electrical shock
	Indicates caution followed by important instructions
	AC input
	AC output
	Requests the user to consult the manual
	Indicates the unit contains a valve-regulated lead acid battery
	Recycle
	DC voltage
	Equipment grounding conductor
	Bonded to ground
	AC voltage
	
	
	

## 1.0 PRODUCT INTRODUCTION

Congratulations on your purchase of the Liebert APS Uninterruptible Power System (UPS). As with every other Liebert product, we stand behind our quality. If you have any questions concerning this UPS, please feel free to contact your local dealer or Liebert representative or call the appropriate Technical Support number listed on the back of this manual.

To ensure proper installation and operation of this unit, please read this manual thoroughly.

The installation must be completed by trained professionals and follow all local codes. General operation of the units can be conducted without any specialized training.

This chapter provides the system description, features, operating principle, operating mode, main components and specifications of the Liebert APS UPS.

### 1.1 System Description

The Liebert APS power system is a modular UPS designed to provide high reliability. It is intended for use with workstations, servers, networks, telecoms and other sensitive electronic equipment. It provides continuous, high-quality AC power to your equipment, protecting it from any power disturbance due to blackouts, brownouts, surges or noise interference.

The Liebert APS UPS is an easily adaptable UPS system. By simply installing additional power or battery modules, you can expand your current system capacity, extend your backup runtime, or provide redundancy. The Liebert APS UPS user interface enables the user to configure the operation according to application requirements. It also informs the user on the status of the UPS and keeps a log of events.

The Liebert APS series UPS contains both transformer-free and transformer-based UPS frames. The use of the transformer-free or transformer-based frames is dependent upon the specific application requirements. The appearance of the different frames is shown in **Figures 1** through **4**.

**Table 1 Frame designation**

UPS Model Number Digits 1-3	Frame Type	Frame Rating
APS1 or APSA or APS5 or APSE	10 Bay Transformer-free	15 kVA redundant
APS2 or APSB or APS6 or APSF	16 Bay Transformer-free	20 kVA redundant
APS3 or APSC	12 Bay Transformer-based	15 kVA redundant
APS4 or APSD	16 Bay Transformer-based	20 kVA redundant

Figure 1 16-bay transformer-free UPS

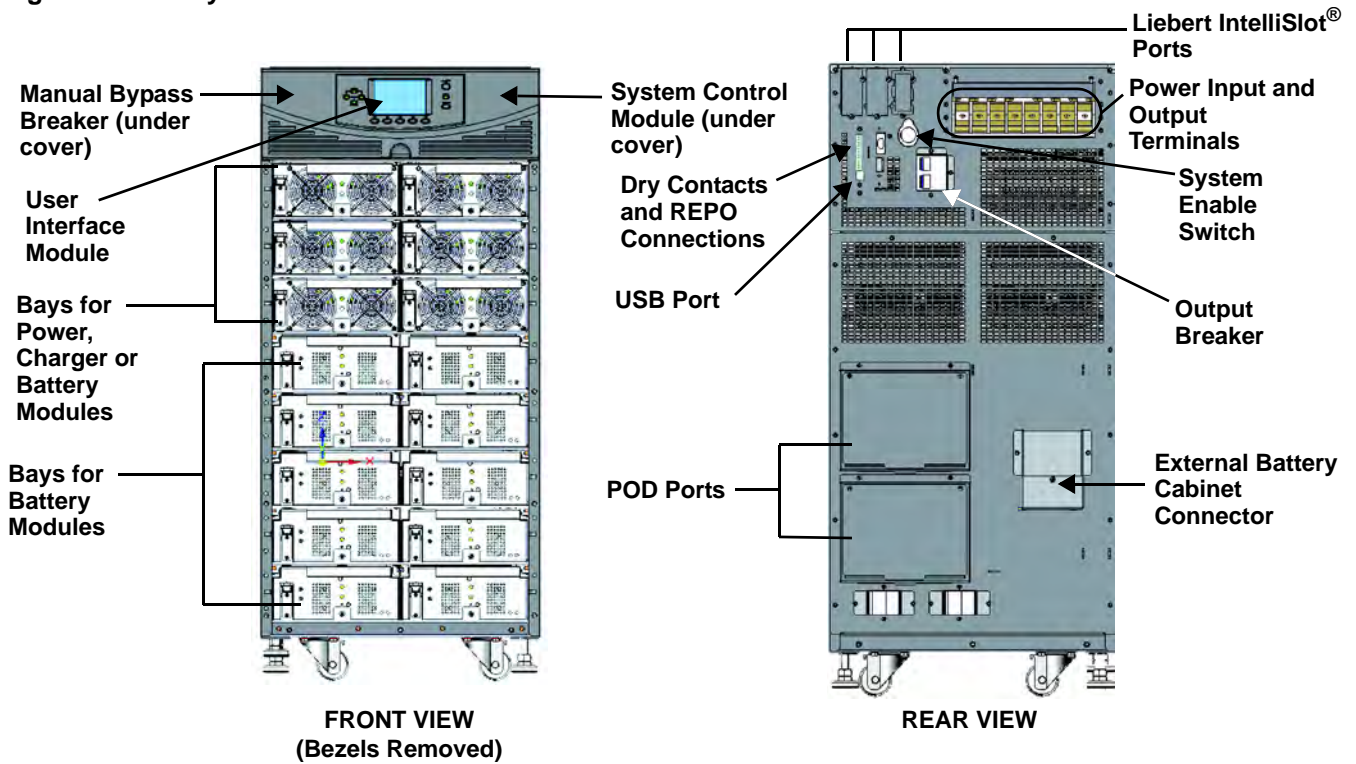


Figure 2 10-bay transformer-free UPS

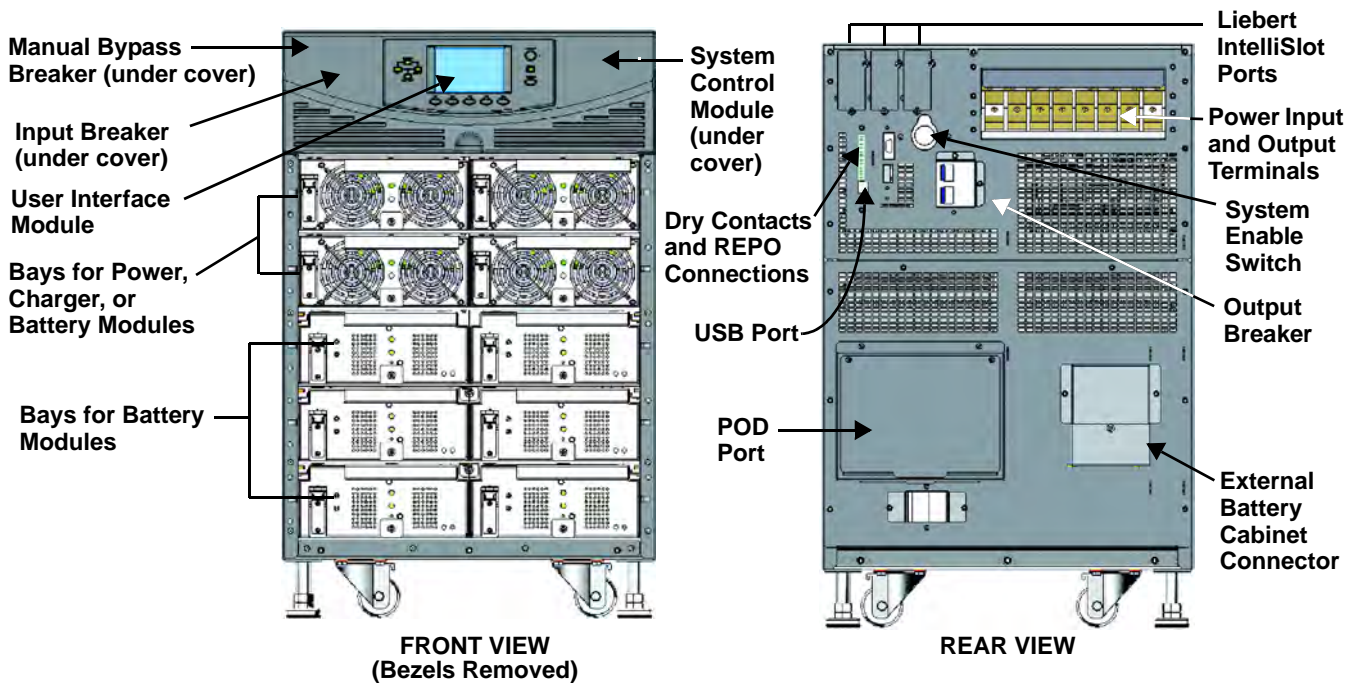


Figure 3 12-bay transformer-based UPS

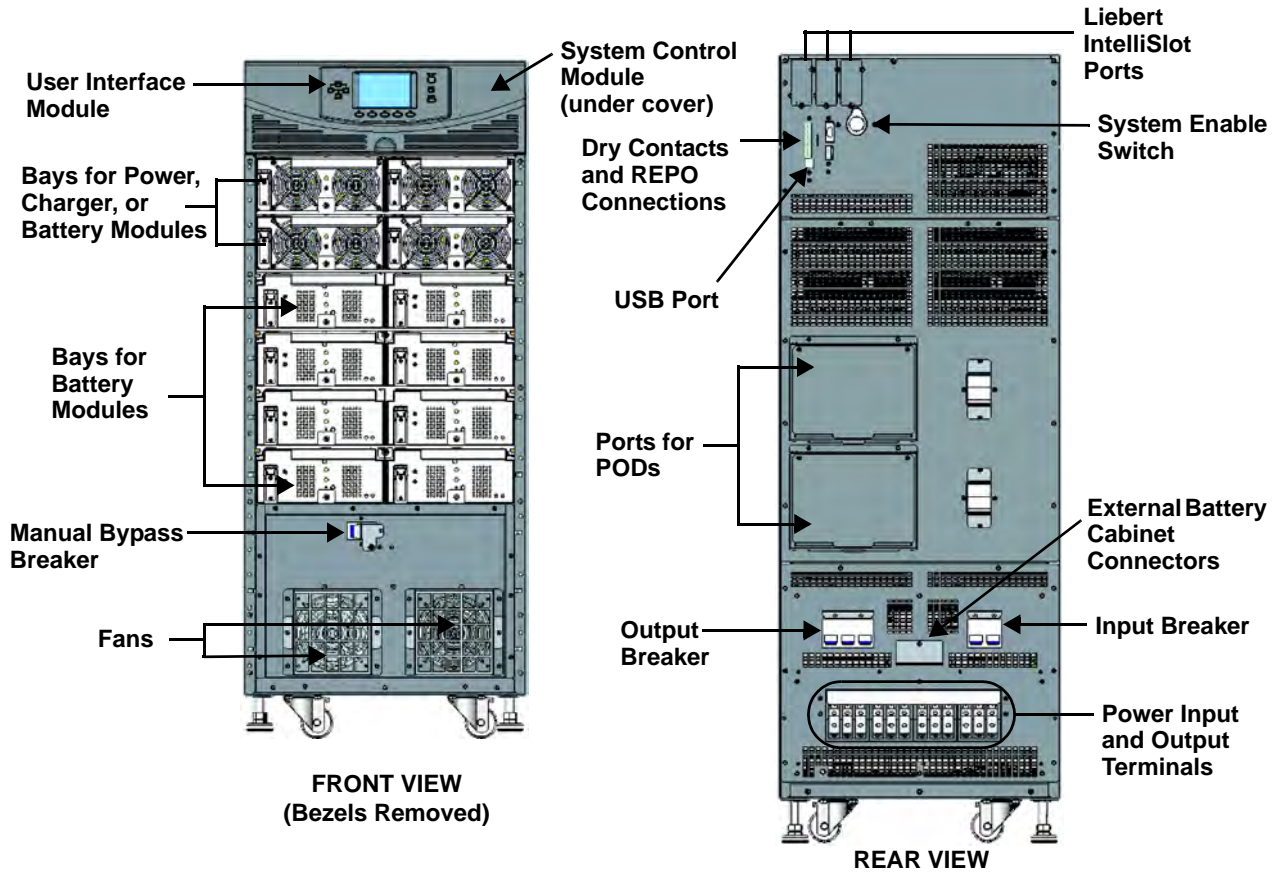
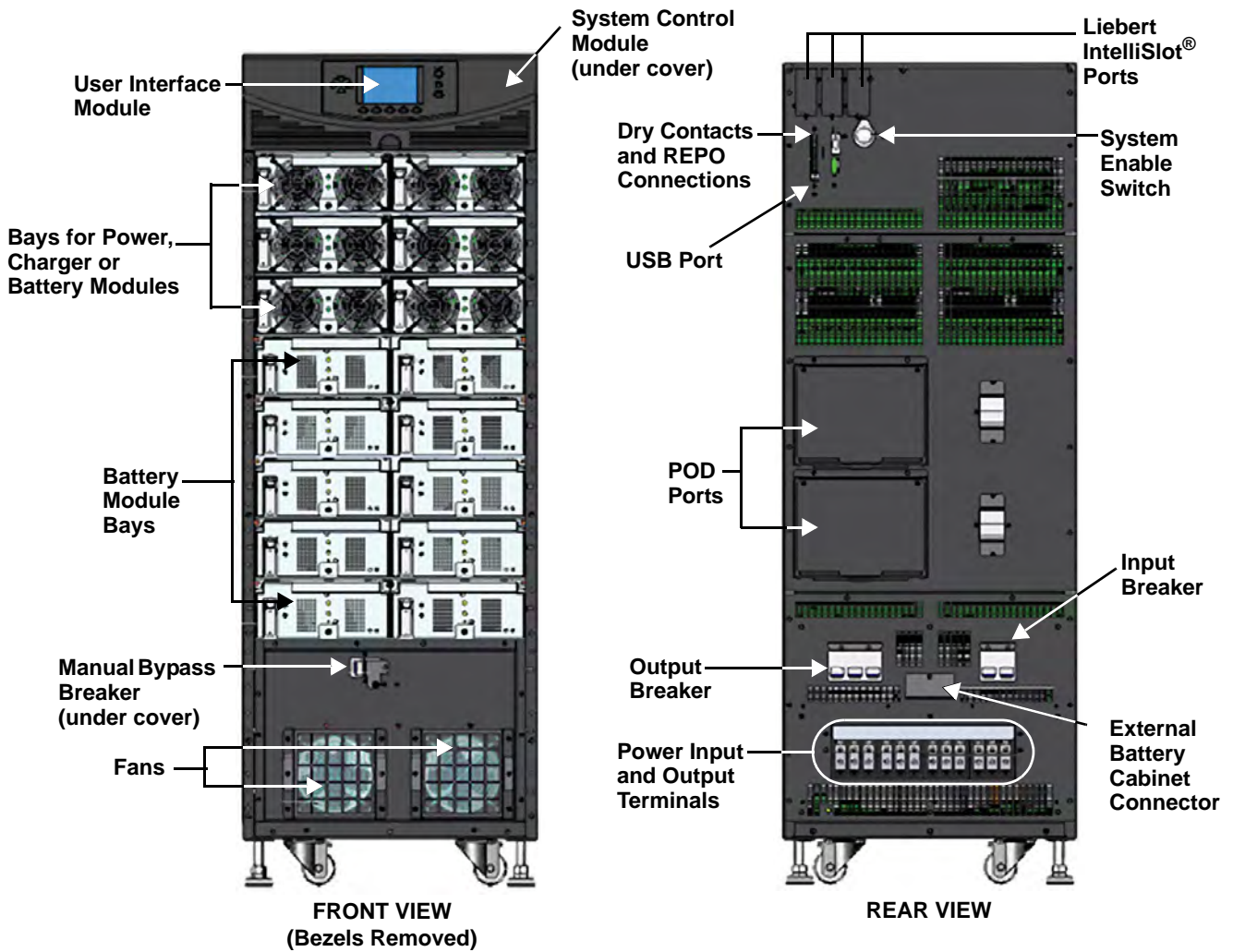


Figure 4 16-bay transformer-based UPS





## 1.2 Features

### Liebert APS UPS

- Flexible extension of capacity, up to 15 or 20kVA modular power, depending upon frame rating
- N + 1 redundancy, improving availability
- Module design, modules hot-swappable by user
- Redundant intelligent module, providing redundant communication path
- Intelligent battery management
- External large batteries can be connected
- Internal automatic and manual bypass
- Transformer-based UPS frames provide output isolation transformer
- Optional 10A battery charger module
- Continuous system monitoring
- User-friendly interface with audible alarms and event logs
- Supporting hot-pluggable and online update
- Compatible with backup generators

### Standard Components

- UPS frame
- User interface module: for comprehensive user indications and programmable controls
- System control modules and system monitor module: for system monitoring and communications
- Power modules: for power conditioning
- Battery modules: for backup power
- Charger module: option for charging batteries and long run time applications
- External battery cabinet: prolongs system run time

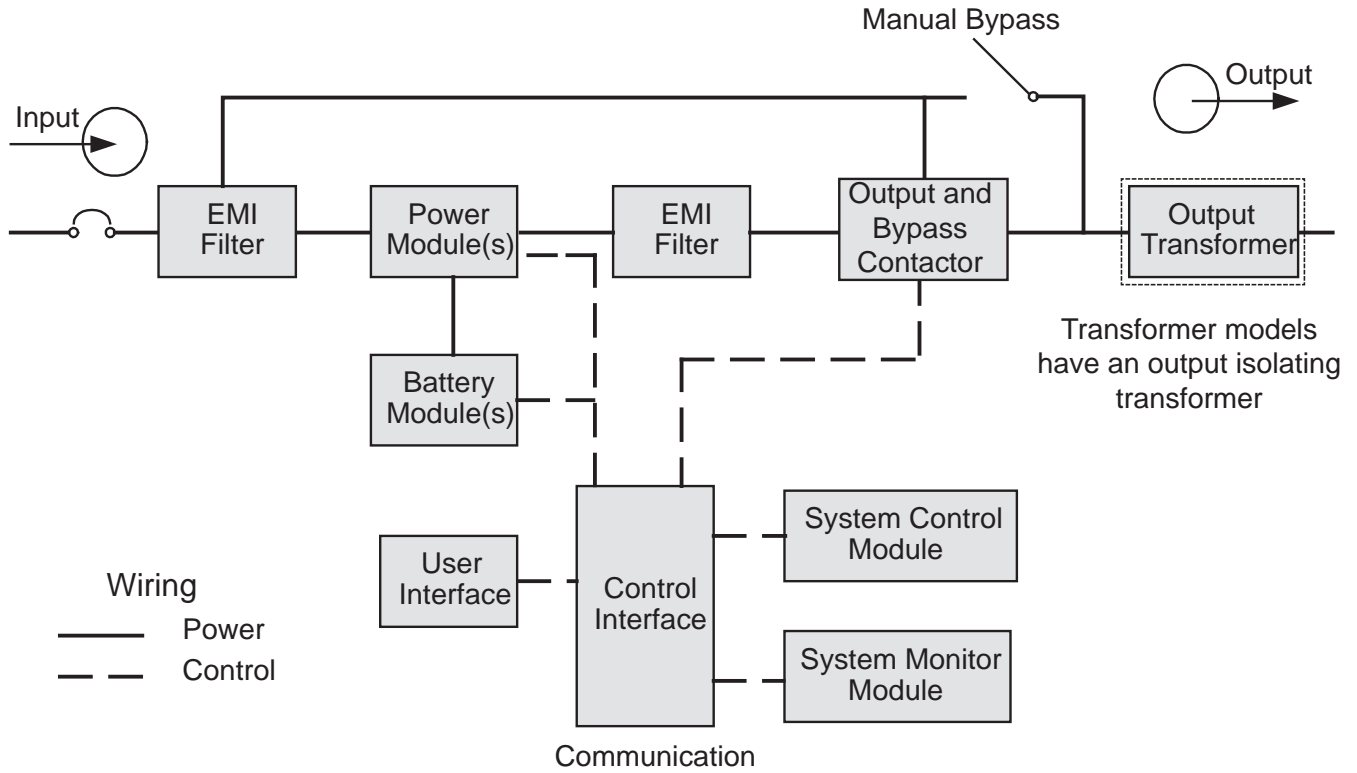
### Communications

- Dry contacts
- Liebert IntelliSlot communication ports
- USB port

## 1.3 Operating Principle

The operating principle of the Liebert APS UPS is shown in **Figure 5**.

Figure 5 Operating principle diagram



The Liebert APS UPS is composed of AC input, EMI filter, power module(s), battery module(s), user interface, control interface, system control module, output and bypass contactor, manual bypass, output transformer (certain frames only) and AC output.

## 1.4 Operating Modes

The Liebert APS UPS is a true online double-conversion system, having the following operating modes:

- Normal Mode
- Backup Mode
- Auto Restart Mode
- Bypass Mode

### Normal Mode

The power module rectifiers derive power from a utility AC source and supply regulated DC power to the inverter. The module's inverter regenerates precise AC power to supply the connected equipment. The battery charger is in the power module and maintains a float-charge on the batteries of the UPS; additionally, the optional charger module can also charge the batteries to maintain a quicker recharge time for long backup time applications.

### Backup Mode

When AC utility fails, the connected equipment is supplied power by the inverter, which obtains energy from the battery modules. The output power will not be interrupted during the failure or restoration of the AC utility/mains source.

### Auto Restart Mode

After a power outage and complete battery discharge, and once AC utility is restored, the UPS will automatically restart and resume supplying power to connected equipment. This feature is enabled at the factory, but can be disabled by the user. The user can also program two auto restart delay settings from the LCD:

- Battery capacity level (%)
- Countdown timer

### Bypass Mode

The bypass provides an alternate path for power to the connected equipment and operates in the following manner:

- Automatic: In the event of an internal fault or should the inverter overload capacity be exceeded, the UPS performs an automatic transfer of the connected equipment from the inverter to the bypass source.
- Manual: Should the UPS need to be taken out of service for limited maintenance or repair, manual activation of the bypass will cause an immediate transfer of the equipment from the inverter to the bypass source.

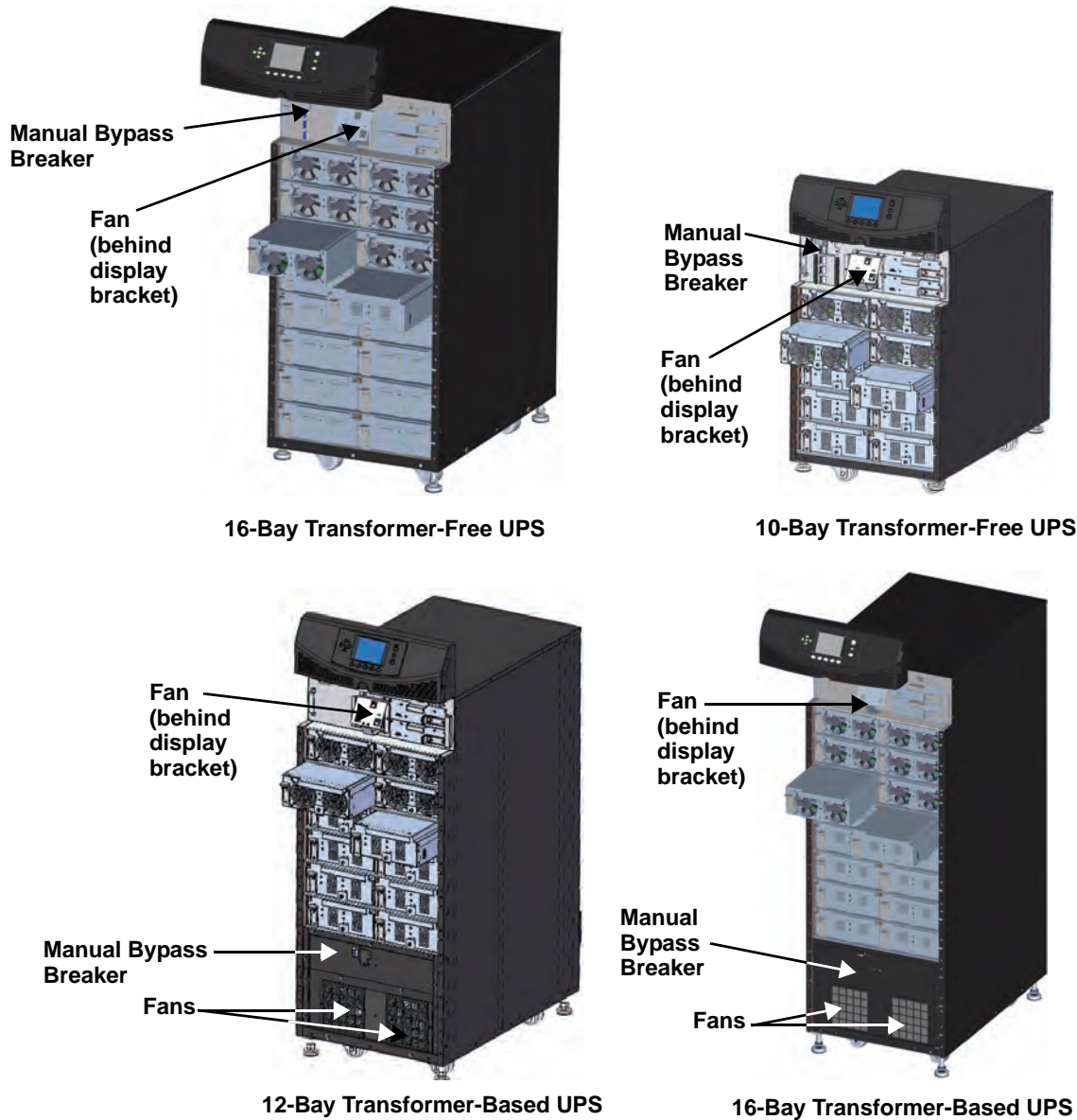
## 1.5 Major Components

This section provides a general description of each component and its functions. Please review this section carefully, as it will give you a better understanding of how the UPS operates.

### 1.5.1 UPS Frame

The UPS frames are shown in **Figure 6**.

**Figure 6** UPS frames, bezels removed



#### NOTE

*In Figure 6, the power module and battery module are extended for illustration purposes only. Extending more than one module at a time could cause the unit to tip over.*

All UPS components are located in the Liebert APS frame. The front of the UPS consists of a series of plastic bezels. By grasping these bezels from the sides and pulling straight out, you can remove the bezel to reveal the battery/power module bays. The standard-model frame provides cooling fans and a manual bypass breaker on its top; the transformer-model frame provides a manual bypass breaker on its bottom and fans on both top and bottom. The user interface module is located above the power/battery module bays for easy access, operation and for viewing UPS operating information. On the lower right part of the user interface module, you will see the system control module bays.

### 1.5.2 User Interface Module

The user interface module is shown in **Figure 7**.

**Figure 7** User interface module



The user interface module is the primary source of communication between the UPS and the user. The user interface module permits:

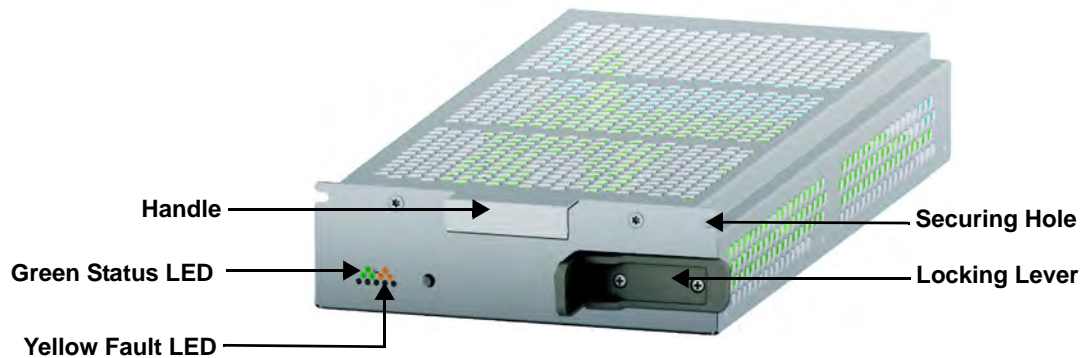
- Viewing the UPS status
- Configuring the system
- Reviewing the event log
- Silencing the audible alarm

Refer to **4.0 - Operation and Display Panel** for details on operating the user interface module.

### 1.5.3 System Control Module and System Monitor Module

The system control module and the system monitor module are the communication backbone of the UPS. They gather input from all modules and process the data to control the operation of the system, including monitoring the condition of each module. Except for the silkscreen, the appearance of the system control module and the system monitor module is as shown in **Figure 8**.

**Figure 8** Liebert APS system control module and the system monitor module

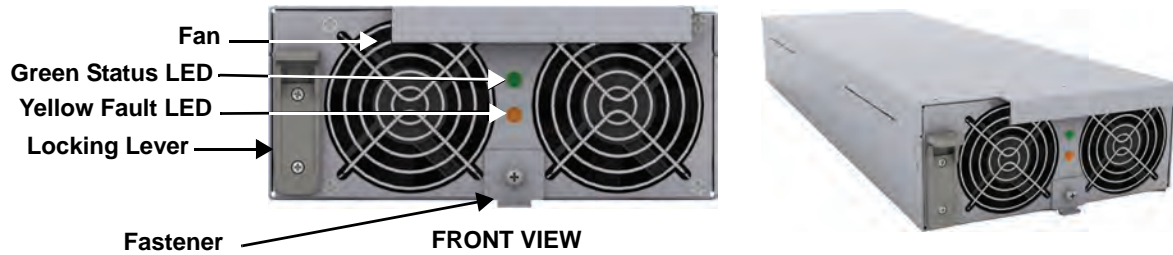


Under normal operation, the green status LED will blink and the yellow fault LED will be Off. For any other condition, refer to **5.0 - Troubleshooting**.

### 1.5.4 Power Module

The power module is shown in **Figure 9**.

**Figure 9** Liebert APS power module



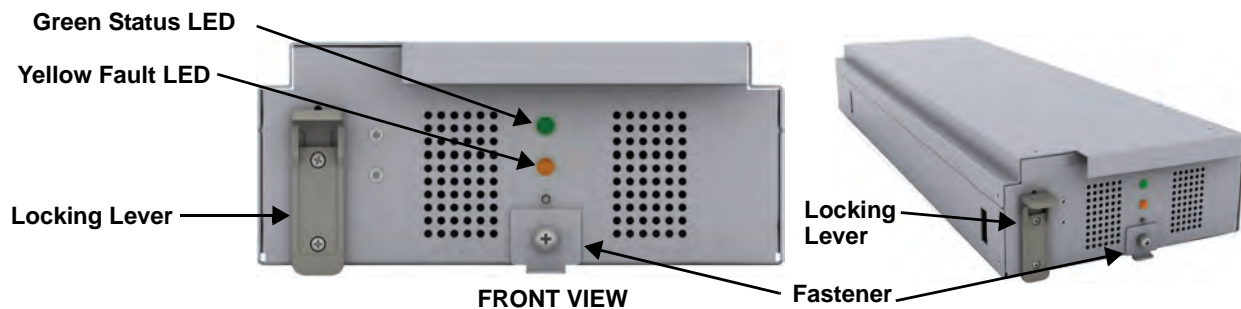
Each power module is an independent 5kVA unit, consisting of a power factor corrected rectifier, battery charger and inverter, with associated monitoring and control circuitry. The modules are connected in parallel for greater capacity and/or redundancy.

The power modules may be added or replaced on-line with no interruption or danger to the connected equipment or user.

### 1.5.5 Battery Module

The battery module is shown in **Figure 10**.

**Figure 10** Battery module appearance



When AC utility fails, the battery module will supply power to the load. Each battery module contains six individual 12V, valve-regulated lead-acid (VRLA) battery blocks. Two battery modules are connected in series to form a battery string.

Each battery module has monitoring and controls to isolate the battery module in the event of a battery failure. The battery strings are connected in parallel to provide backup time and/or redundancy.



#### NOTE

*Two battery modules must be installed in the same layer to make a complete battery string.*

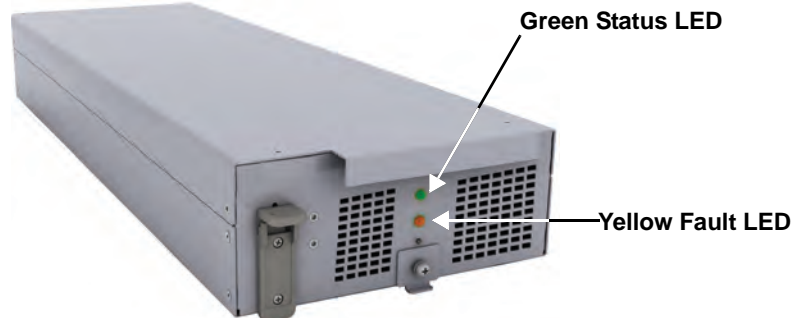
The battery modules may be added or replaced on-line with no interruption or danger to the connected equipment, provided that the UPS is not operating on battery.

Under normal operation, the green status LED will blink continuously and the yellow fault LED will be Off. For any other condition, refer to **5.0 - Troubleshooting**.

### 1.5.6 Charger Module

Figure 11 shows the charger module.

Figure 11 Appearance of the charger module



In AC mains mode, the charger module charges the system battery modules or external battery cabinet. Each charger module is rated to deliver 10A charging current. The charger module has an independent control function and maintains real-time communication with the system and the battery modules to ensure stable charging and fault protection.

The charger module may be added or replaced on-line with no interruption or danger to the user, connected battery system or connected equipment.

### 1.5.7 External Battery Cabinet (EBC)

The external battery cabinet is divided into nine layers: the upper seven layers are for use with the intelligent battery modules, and the lower two are used for overcurrent protection for each battery cabinet. For normal operation, two battery modules must be inserted in the same layer of the frame to create a complete string. The battery module strings work in parallel to provide longer backup time for the UPS. A Liebert APS can be configured with, at most, four external battery cabinets.

An external battery cabinet is shown in Figure 12.

Figure 12 External battery cabinet



## 2.0 INSTALLATION

This chapter describes UPS installation, including installation preparation, unloading the UPS, mechanical installation, installing modules and cable connection.

### 2.1 Unpacking Inspection

Upon receiving the UPS, uncrate it and conduct the following checks:

- Inspect the UPS appearance for shipping damage. Report any shipping damage to the carrier and send a copy to your Emerson Network Power® representative.
- Check against the delivery list to ensure that the package contains the correct number and type of accessories. If there is any discrepancy, contact the distributor immediately.

#### 2.1.1 Installation Environment



#### NOTE

*Operating the UPS in temperatures above 77°F (25°C) will reduce battery life.*

The UPS environment must be free of conductive contaminants and excessive moisture (water and condensation), flammable vapors, chemical fumes, corrosive gases and liquids.

#### 2.1.2 Installation Tools

The tools required to properly set up your UPS are listed below:

- Pallet jack
- 17mm (11/16") wrench or socket
- 13mm (1/2") wrench or socket
- 10mm wrench or socket
- #1 and #3 Phillips screwdrivers
- Torque wrench

#### 2.1.3 Installation Site

Consider the weight and size of the Liebert APS when deciding where to install the unit. Verify that the floor can support the weight of a fully loaded unit, any accessories and external cabinets.

Verify that the UPS will be in a well-ventilated area with at least 12 inches (305mm) clearance behind it. The UPS is air-cooled, utilizing internal fans. Air is drawn into the front of the UPS and is exhausted through ventilation grilles in the back. The UPS should also have at least 39 inches (1m) clearance in front for service and to meet many local and national building codes.

**Figure 13 Front and rear installation clearances**





## 2.2 Unloading the UPS

The unit frame is bolted to the shipping pallet to ensure safety during shipping. Emerson recommends keeping the unit bolted to the pallet and using a pallet jack to transport the unit to its installation location.



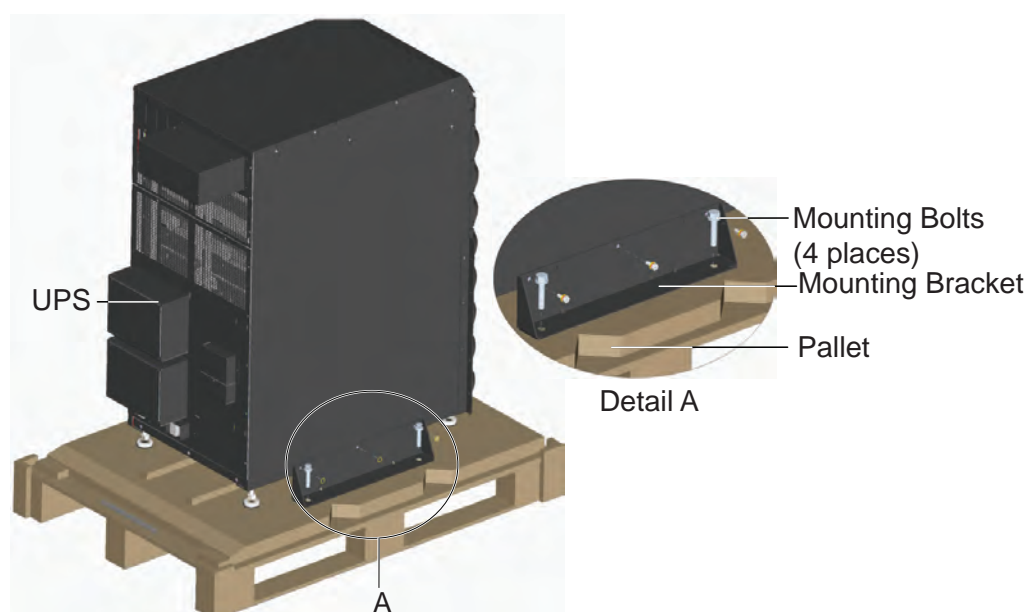
### NOTE

*This UPS is very heavy. At least two people should assist in unloading it from the pallet.*

To unload the UPS:

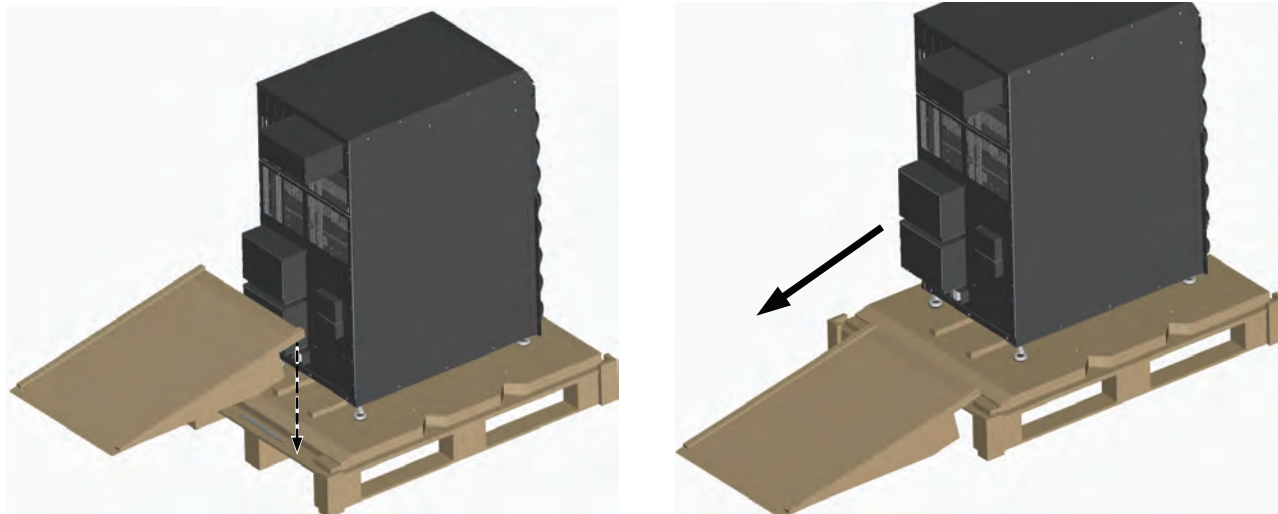
1. Move the UPS to its installation site and remove the package paper.
2. Use a 17mm (11/16") wrench, to remove the four mounting bolts from the pallet brackets (see **Figure 14**).
3. Remove the mounting brackets from the UPS with a 10mm wrench or socket or a #3 Phillips screwdriver.

**Figure 14 Remove the mounting brackets**



4. Raise the four leveling feet to provide clearance between the pallet and the UPS frame.
5. Connect the ramp to the UPS pallet, as shown in **Figure 15**.
6. Roll the UPS slowly down the ramp until it is on a level surface, as shown in **Figure 15**.

**Figure 15 Connect the ramp and remove UPS**



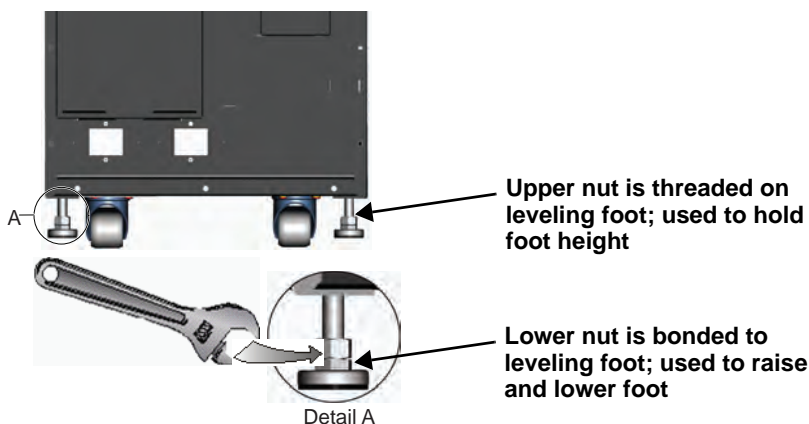
## 2.3 Mechanical Installation

Two installation modes are available for the Liebert APS UPS: tower installation and rack installation.

### 2.3.1 Tower Installation

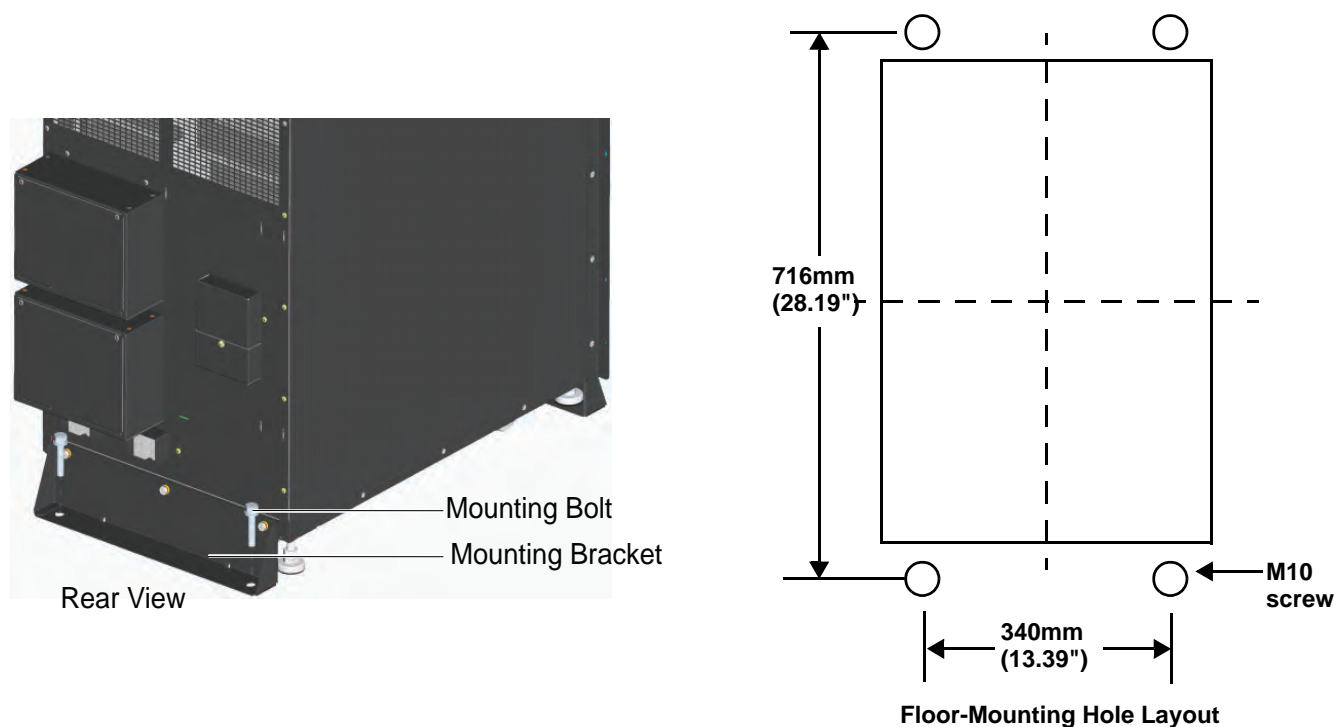
1. Once the UPS is in the desired location, adjust the leveling feet to secure its position, as shown in **Figure 16**.
  - a. Use an open end wrench to turn the lower nut to raise or lower the leveling foot.
  - b. After the unit is level, tighten the upper nut against the frame to prevent the height from changing.

**Figure 16 Adjust the leveling feet**



2. For added stability or earthquake-resistant installations, the shipping brackets can be used to secure the unit to the floor.
  - a. Drill holes 10.3mm (13/32") in the floor for stationary mounting; these will accommodate the mounting bolts removed from the pallet. Refer **Figure 17** for the layout.
  - b. Use the mounting screws to install the mounting brackets on the front and rear of the UPS.
  - c. Secure the mounting brackets to the floor with the mounting bolts (see **Figure 17**).  
For greater stability, use a higher-grade bolt.

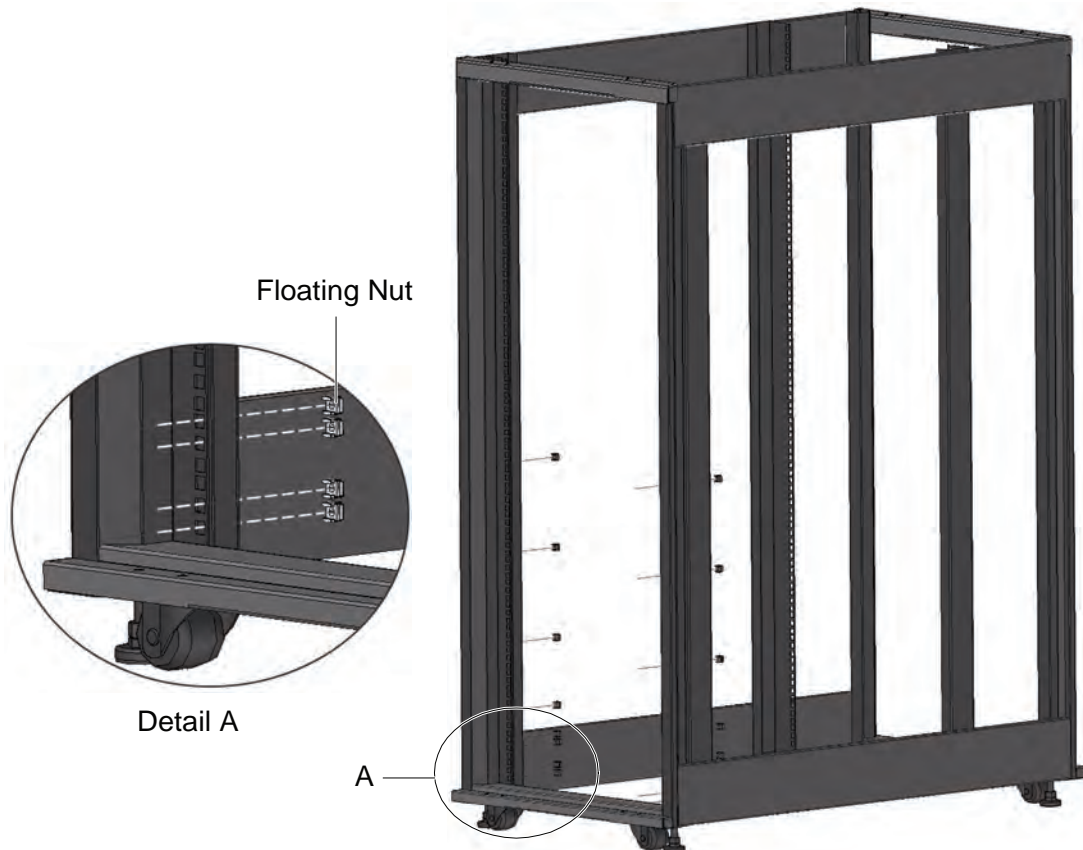
**Figure 17 Installation position and drilling hole dimensions for stationary mounting**



### 2.3.2 Rack Installation

1. Install the cage nuts on the corresponding positions in the rack, as shown in **Figure 18**.
  - a. Install cage nuts in the two lower square holes of 1U space and in the two upper square holes of 2U space of all four rack posts. These cage nuts will secure the optional shelf that will support the weight of the Liebert APS.
  - b. Install a cage nut in the middle square hole of 4U, 6U, 10U, 12U spaces, respectively, again in all four posts. The cage nuts will help secure the UPS in the rack.

**Figure 18** Install cage nuts



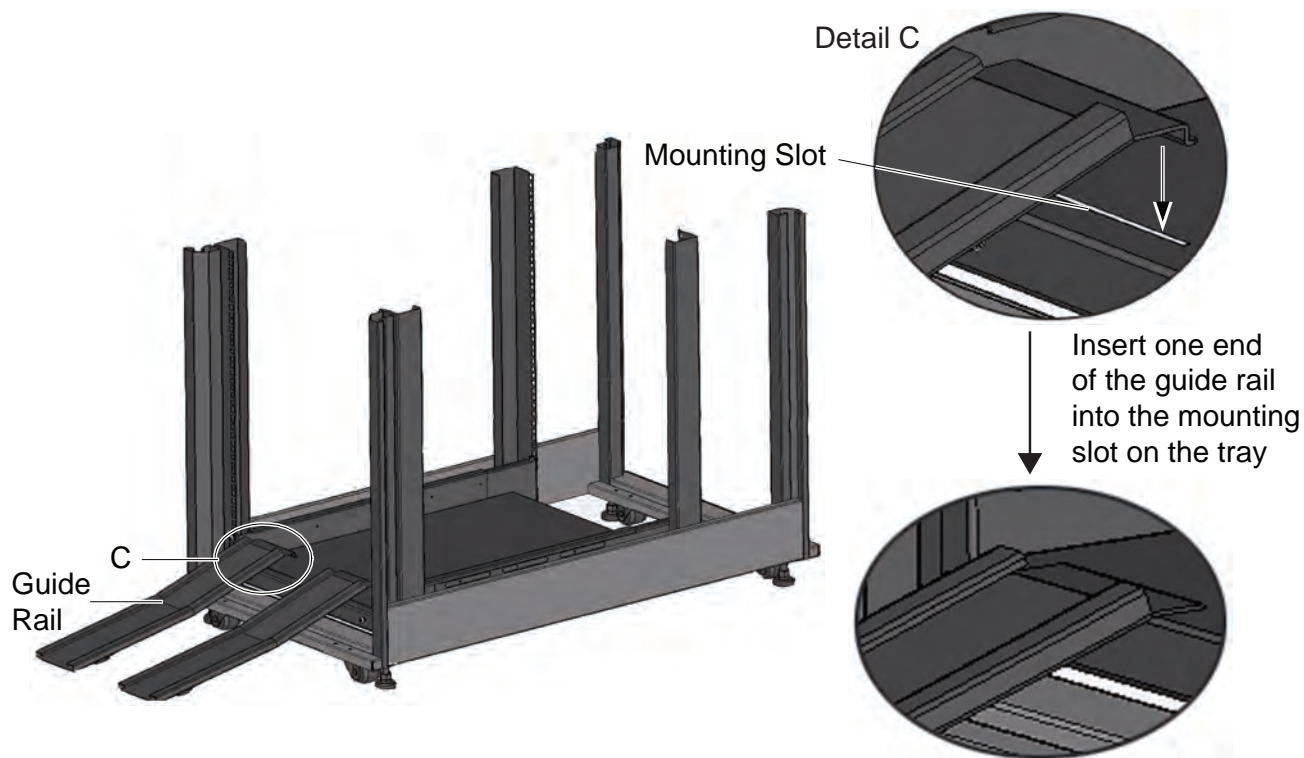
2. Install the rack-mount shelf on the corresponding position between 1U space and 2U space on the bottom of the rack, as shown in **Figure 19**.

**Figure 19** Install the tray



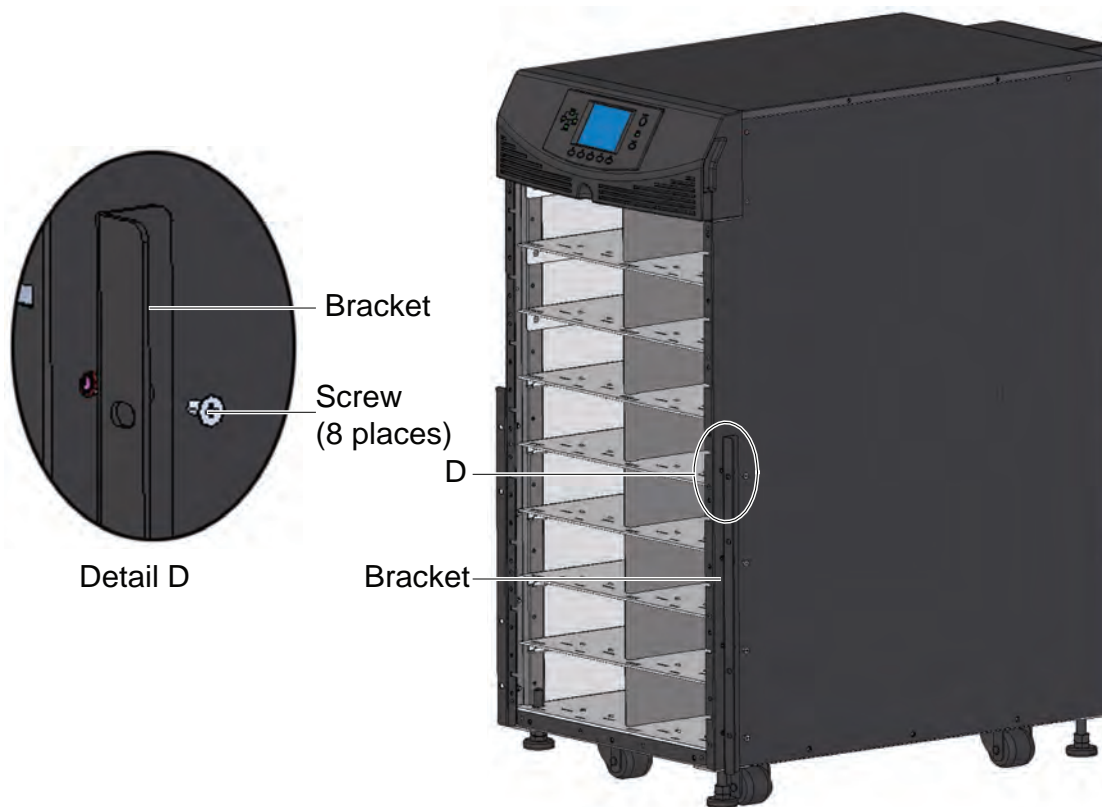
3. Install the guide rails (ramp) in the mounting slot at the front of the tray, as shown in **Figure 20**.

Figure 20 Install the guide rails



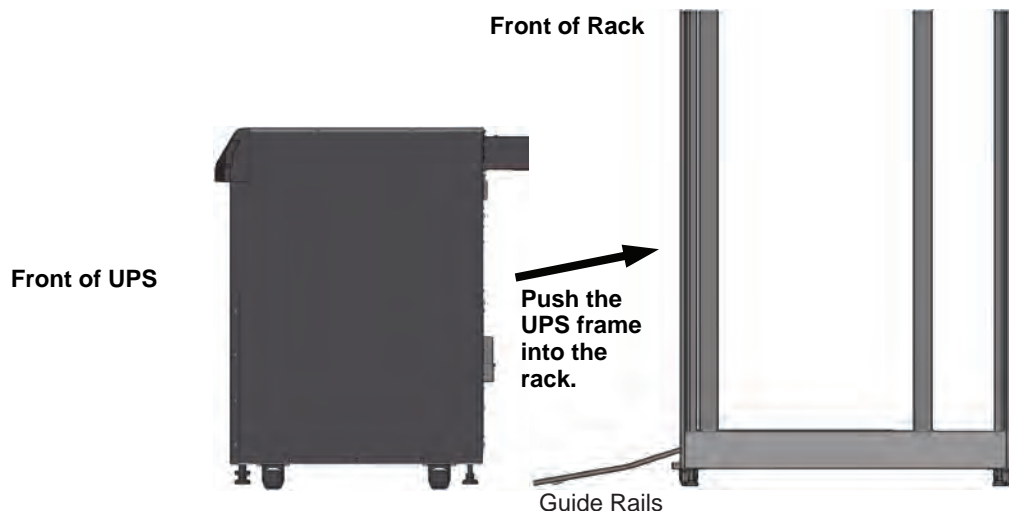
4. Unscrew the 10 screws on the front of the two side panels of the UPS frame.
5. Use those screws to attach the brackets to each side of the UPS frame, as shown in **Figure 21**.

Figure 21 Install the brackets



6. Push the Liebert APS frame slowly into the enclosure from the front, as shown in **Figure 22**. The rear of the UPS goes into the rack first when installing through the front of the rack.

Figure 22 Push the UPS frame into the rack



- Use eight panel screws to secure the UPS frame to the rack posts, as shown in **Figure 23**.

**NOTE**

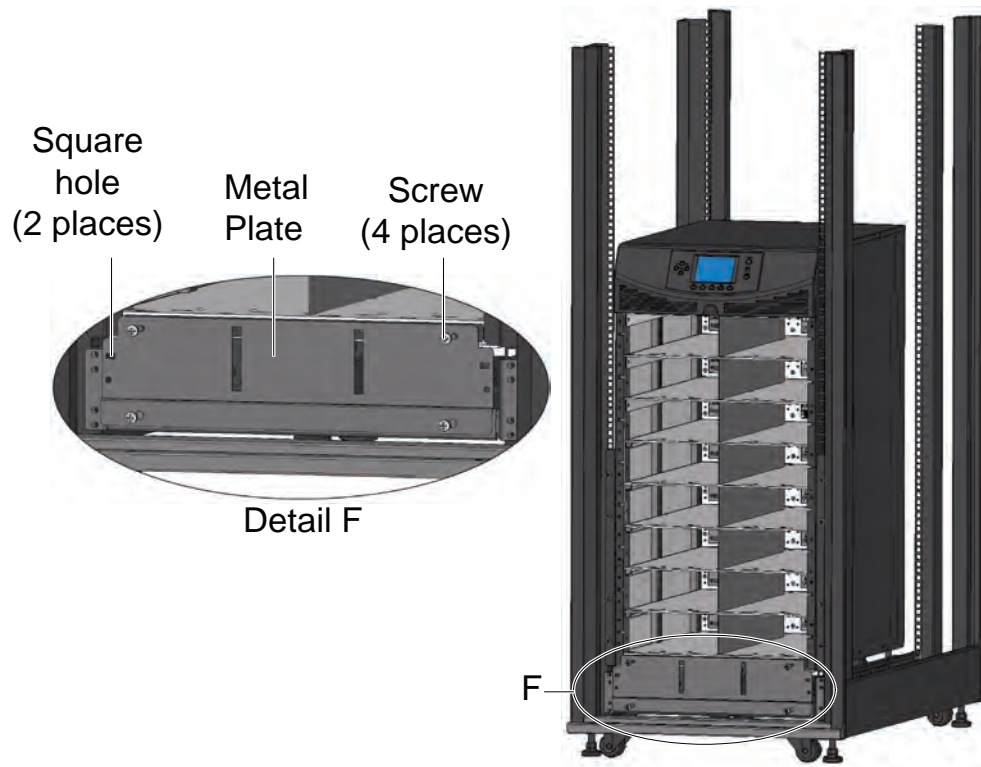
*It might be necessary to use the leveling feet to get the holes to align*

Figure 23 Fix the UPS frame



- Use four screws to install the metal plate (accessory in the rack-mount kit) on the corresponding position on the lower front part of the UPS frame
- Insert the plastic bezel into the square holes of the metal plate, as shown in **Figures 24 and 25**.

Figure 24 Install the metal plate



10. The installation is complete, as shown in **Figure 25**.

Figure 25 Installation completed



## 2.4 Module Installation

The Liebert APS ships from the factory configured (modules prepopulated) and tested as a system to the customer's requirements. If any modules were removed to facilitate ease of installation, follow the steps below to re-insert them properly.

### 2.4.1 Installing Power Module, Battery Module and Charger Module

1. Lift module to appropriate bay, resting end of module on bay shelf.



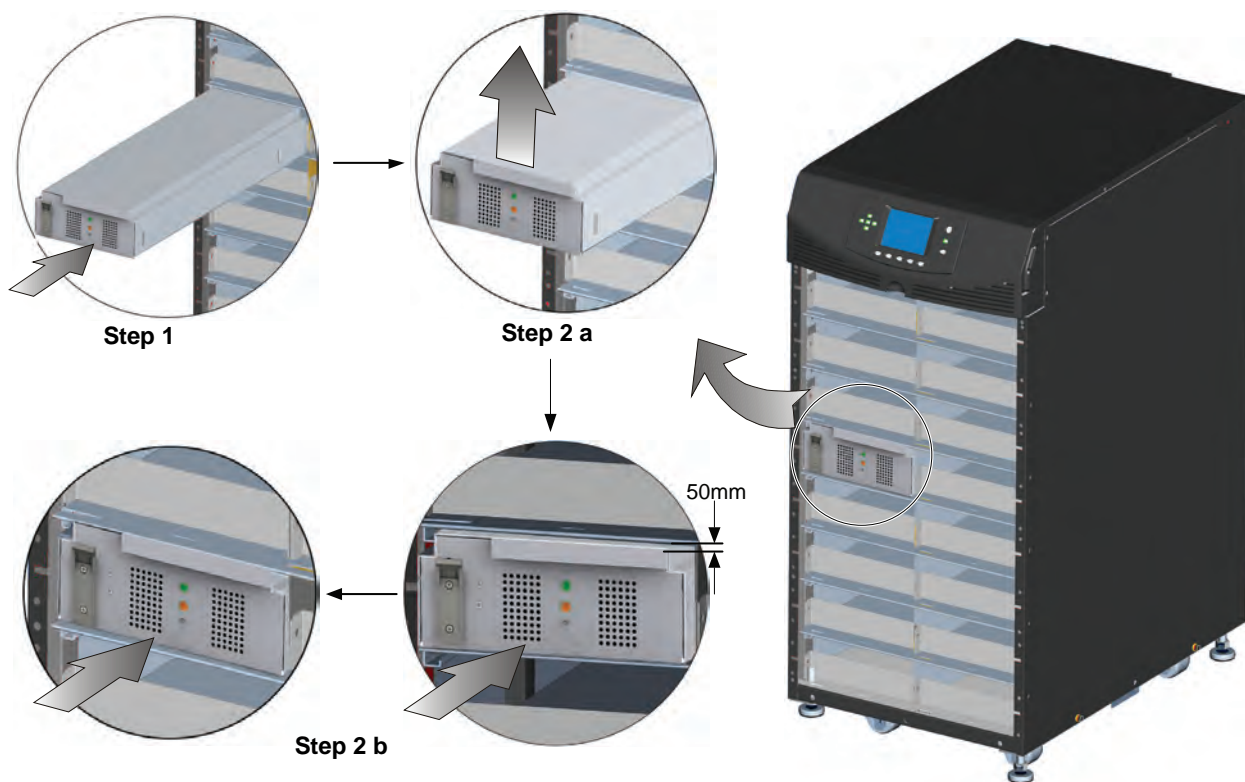
#### NOTE

*Use caution not to rest the module on any of the plastic bezels, this could damage the bezel.*

*Two battery modules must be installed in the same row to complete the battery string.*

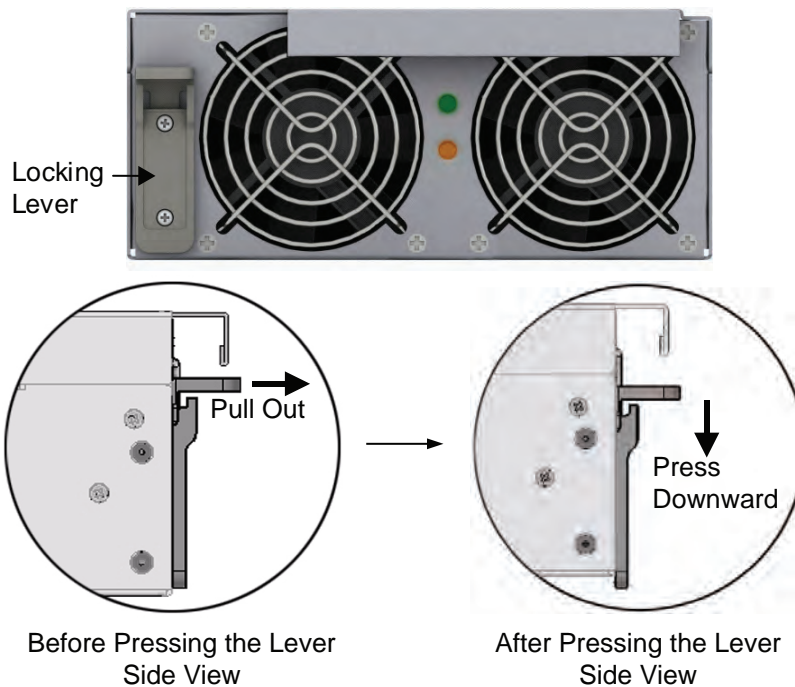
2. Push the module into the bay slowly. The module will be locked until 1/3 is in.
  - a. At this point, lift the module up and continue pushing it until about 5cm of the module is still out of the bay.
  - b. Push it firmly and smoothly to ensure that the module is fully inserted, as shown in **Figure 26**.

**Figure 26** Insert the power module, battery module and charger module



3. Use a #2 Phillips screwdriver to install the module-securing bracket, and then press the lever down into the bracket, as shown in **Figure 27**.

Figure 27 Lever and fastener

**NOTE**

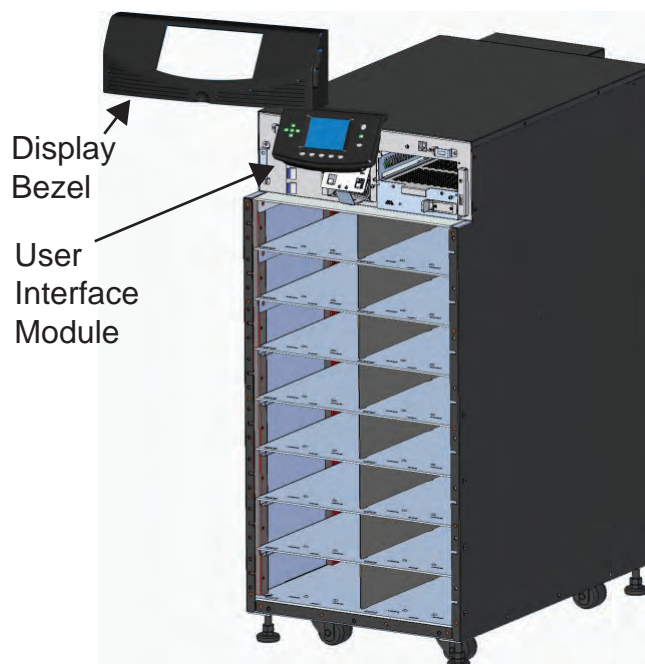
*If the lever of the module cannot be pressed down smoothly, remove the module and reinstall it.*

4. Replace the small plastic bezels.

### 2.4.2 Install System Control and System Monitor Modules

1. Remove the display bezel and the user interface (LCD) module on top of the frame, as shown in **Figure 28**.

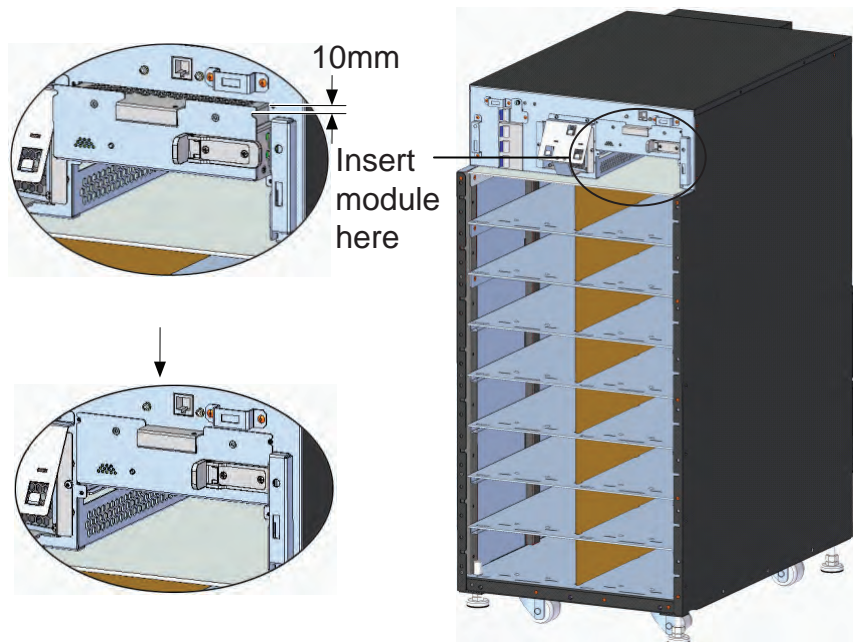
Figure 28 Remove large plastic bezel and user interface module



2. Push the module slowly until about 1cm of the module is still out of the bay, and then press it firmly to ensure that the module is fully inserted, as shown in **Figure 29**.

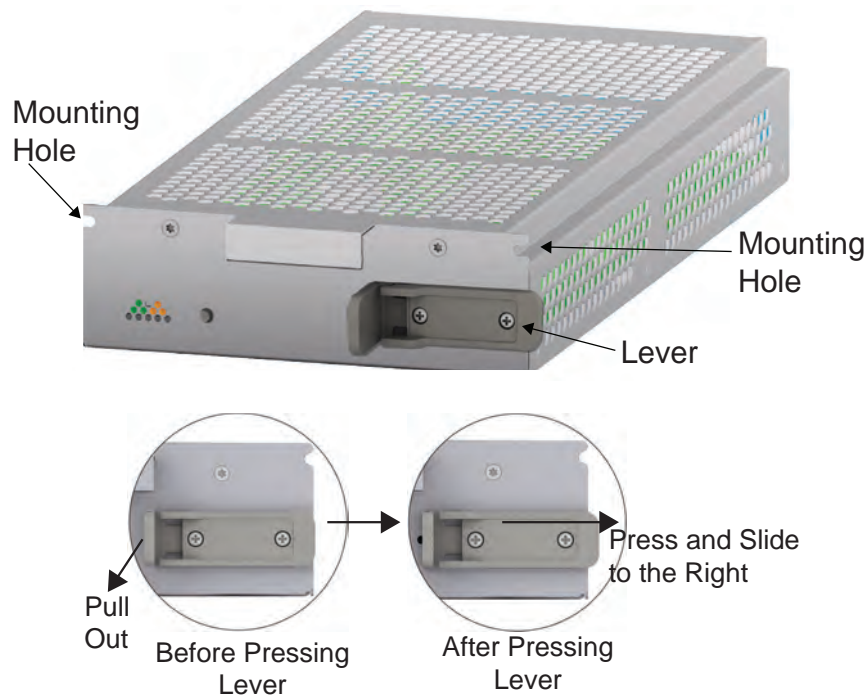


**Figure 29 Insert the System Control and System Monitor module**



3. Use a #2 Phillips screwdriver to install the screws into the holes on each end.
4. Slide the lever toward the right, as shown in **Figure 30**.

**Figure 30 Lever and fastener on System Control and System Monitor Module**



5. Replace the LCD module and display bezel.

## 2.5 Cable Connection



### WARNING

Risk of electric shock. Can cause injury or death.

Disconnect local and remote power supplies before working within.

Read this section thoroughly before attempting to install wiring to this unit.

Ensure that all the UPS input sources are disconnected off before attempting to install wiring to this unit.

This UPS cables should be connected by a properly trained and qualified electrician.

Refer to the unit model number in **Table 2** to determine which instructions to use for installation.

**Table 2 Cable connection method reference**

UPS Model # Digits 1-3	Frame Type	Manual Section
AS1 or ASA	10 Bay Transformer-free	2.5.1
AS2 or ASB	16 Bay Transformer-free	2.5.1
AS3 or ASC	12 Bay Transformer-based	2.5.2
AS4 or ASD	16 Bay Transformer-based	2.5.2
AS5 or ASE	10 Bay Transformer-free	2.5.3
AS6 or ASF	16 Bay Transformer-free	2.5.3

### 2.5.1 Transformer-Free UPS Cable Connection

A junction box is factory-installed on each model of the Liebert APS to ease cable connection.

Select the appropriate input cables according to **Table 3** and **Table 4** based on the UPS rating and mains frequency; however, it is recommended that you size the over current protection and wiring for the frame rating to easily allow upgrades to the UPS system.

**Table 3 Input cable selection list—60Hz**

Maximum System Rated Load	Input voltage - 200VAC		Input voltage - 208VAC		Input voltage - 240VAC	
	Maximum Current in UPS Mode	Recommended Input Protection Circuit Breaker	Maximum Current in UPS Mode	Recommended Input Protection Circuit Breaker	Maximum Current in UPS Mode	Recommended Input Protection Circuit Breaker
5kVA	27A	50A	26A	50A	23A	50A
10kVA	53A	70A	51A	70A	45A	70A
15kVA	80A	100A	77A	100A	67A	100A
20kVA	106A	125A	102A	125A	90A	125A

The power input and output terminals accept a maximum cable cross-sectional area of 35mm<sup>2</sup> (2AWG); the minimum cable cross-sectional area is 16mm<sup>2</sup> (6AWG); the rated torque is 4.52Nm (40 in-lb).

Use of 90°C copper wire is recommended

**Table 4 Input cable selection list—50Hz**

Maximum System Rated Load	Input Voltage - 220VAC		Input Voltage - 230VAC		Input Voltage - 240VAC	
	Maximum Current in UPS Mode	Recommended Input Protection Circuit Breaker	Maximum Current in UPS Mode	Recommended Input Protection Circuit Breaker	Maximum Current in UPS Mode	Recommended Input Protection Circuit Breaker
5kVA	25A	63A	24A	63A	23A	63A
10kVA	49A	63A	47A	63A	45A	63A
15kVA	73A	100A	70A	100A	67A	100A
20kVA	97A	125A	93A	125A	90A	125A

The power input and output terminals accept a maximum cable cross-sectional area of 35mm<sup>2</sup> (2AWG); the minimum cable cross-sectional area is 16mm<sup>2</sup> (6AWG); the rated torque is 4.52Nm (40 in-lb).

90°C copper wire recommended

To connect the cable:



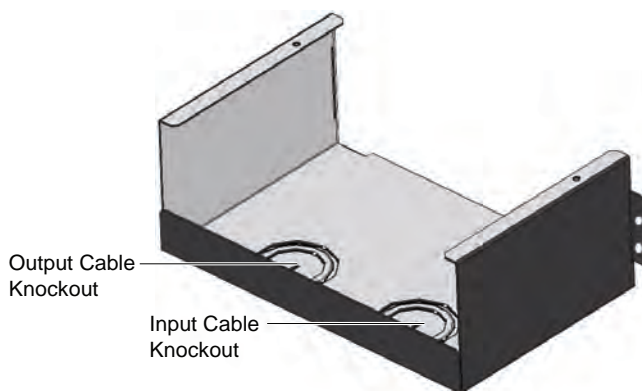
**NOTE**

*Input and output cables must be run in separate conduit before cable connection.*

*For the user whose input power grid is L-L line voltage, the input N of the power input and output terminals will connect live wire, so the output N of the power input and output terminals is also live wire.*

1. Remove the knockouts at the junction box (see **Figure 31**) and pull the cables through them, leaving some slack for installation.

**Figure 31 Knockouts**



2. Connect the cables to the corresponding terminal of the power input and output terminals.
3. Tighten the screws to 4.52Nm (40 in-lb) with a 13mm (1/2") torque wrench.
4. Respectively, secure the conduit of the input/output cables through the cable bridges on the rear panel of the UPS (see **Figure 31**).

The connection methods in the single-phase input mode and the 3-phase input mode are shown in **Figures 32** and **33**, respectively. Installation of the factory-provided copper bar is essential in the single-phase input mode. The copper busbar is in the accessory bag included with the UPS.

**Figure 32 Connection in single-phase input**

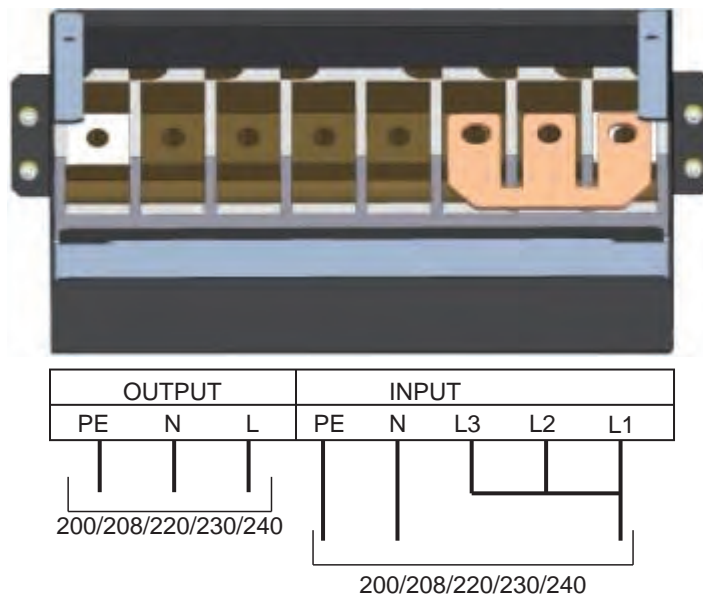
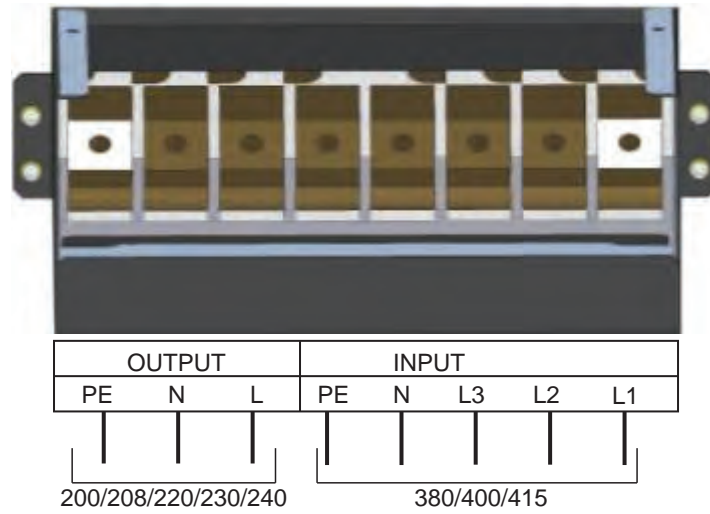


Figure 33 Connection in 3-phase input



## 2.5.2 Transformer-Based UPS Cable Connection



### NOTE

After the output transformer is installed, if the startup is on bypass, the UPS has a six-cycle inrush current that is up to 20 times the rated output current. This must be taken into account when selecting the input overload protection device at the AC input supply distribution point.

To avoid random tripping on startup, Emerson® recommends that the AC input supply be protected with a circuit breaker capable of withstanding this initial inrush (the MCB is derated according to the D curve or TYPE 4).

This UPS is fitted with EMI filters. Earth leakage current is less than 40mA. Transient and steady state earth leakage currents may occur when starting the UPS. This should be taken into account when selecting transient RCCB or RCCD (leakage current devices of the UPS and load).

The MCB of the AC power supply connected to the UPS input must bear this warning:

**Disconnect the connection with UPS before maintaining this circuit**

The warning is required because the UPS has no autofeeding protection device.

The UPS grounding should be in accordance with local regulations.

A junction box is factory-installed on all models of the Liebert APS to ease cable connection.

Select the appropriate input cables according to **Table 5** and **Table 6** based upon the UPS rating and mains frequency. Emerson recommends sizing the frame's overcurrent protection and wiring to permit easier UPS system upgrades.

**Table 5 Input cable selection for Transformer-based frames (60 Hz)**

Maximum System Rated Load	Input Voltage - 200VAC		Input Voltage - 208VAC		Input Voltage - 240VAC	
	Maximum Current in UPS Mode	Recommended Input Protection Circuit Breaker	Maximum Current in UPS Mode	Recommended Input Protection Circuit Breaker	Maximum Current in UPS Mode	Recommended Input Protection Circuit Breaker
5kVA	27A	50A	26A	50A	23A	50A
10kVA	53A	70A	51A	70A	45A	70A
15kVA	80A	100A	77A	100A	67A	100A
20kVA	106A	125A	102A	125A	90A	125A

The power input and output terminals accept a maximum cable cross-sectional area of 70mm<sup>2</sup> (2/0AWG); the minimum cable cross-sectional area is 16mm<sup>2</sup> (6AWG). The rated torque is 12.43Nm (110 in-lb).  
90°C copper wire recommended.

**Table 6 Input cable selection for Transformer-based frames (50 Hz)**

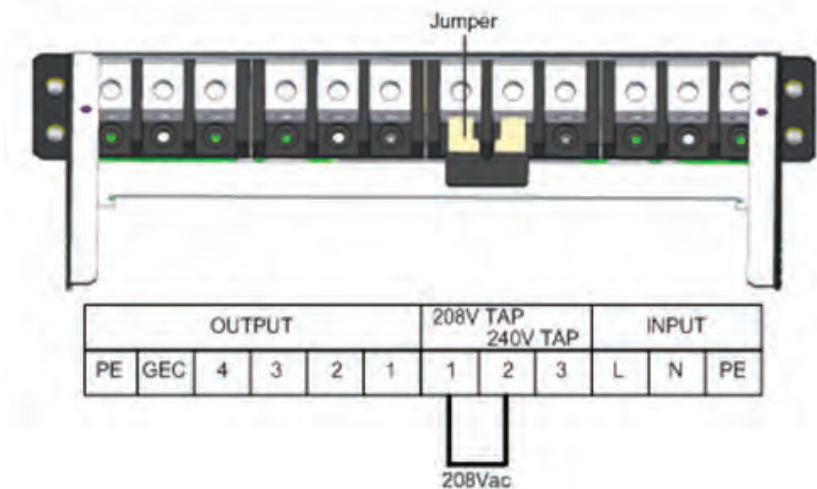
Maximum System Rated Load	Input Voltage - 220VAC		Input Voltage - 230VAC		Input Voltage - 240VAC	
	Maximum Current in UPS Mode	Recommended Input Protection Circuit Breaker	Maximum Current in UPS Mode	Recommended Input Protection Circuit Breaker	Maximum Current in UPS Mode	Recommended Input Protection Circuit Breaker
5kVA	25A	63A	24A	63A	23A	63A
10kVA	49A	63A	47A	63A	45A	63A
15kVA	73A	100A	70A	100A	67A	100A
20kVA	97A	125A	93A	125A	90A	125A

The power input and output terminals accept a maximum cable cross-sectional area of is 70mm<sup>2</sup> (2/0AWG); the minimum cable cross-sectional area is 16mm<sup>2</sup> (6AWG). The rated torque is 12.43Nm (110 in-lb).  
90°C copper wire recommended.

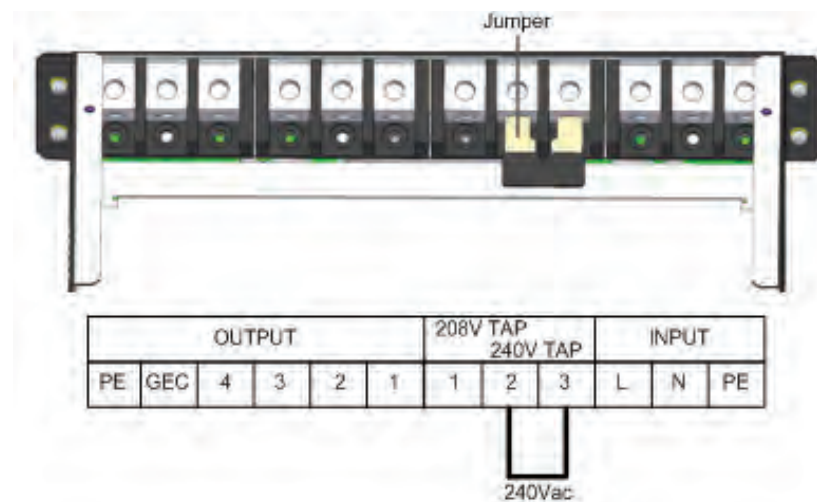
### Configuring the Bypass Voltage

The UPS bypass voltage is factory-set to 208V (the jumper copper bar has been installed). Should the user have a utility supply of 200V/220V/230V/240V, the bypass voltage jumper must be changed to ensure correct output voltages when in bypass mode. Configuring the bypass voltage jumper settings are shown in **Figures 34** and **35**. Refer to **Table 7** for the proper setting according to the AC mains voltage configuration.

**Figure 34** Setting bypass voltage jumper (default: 208VAC)



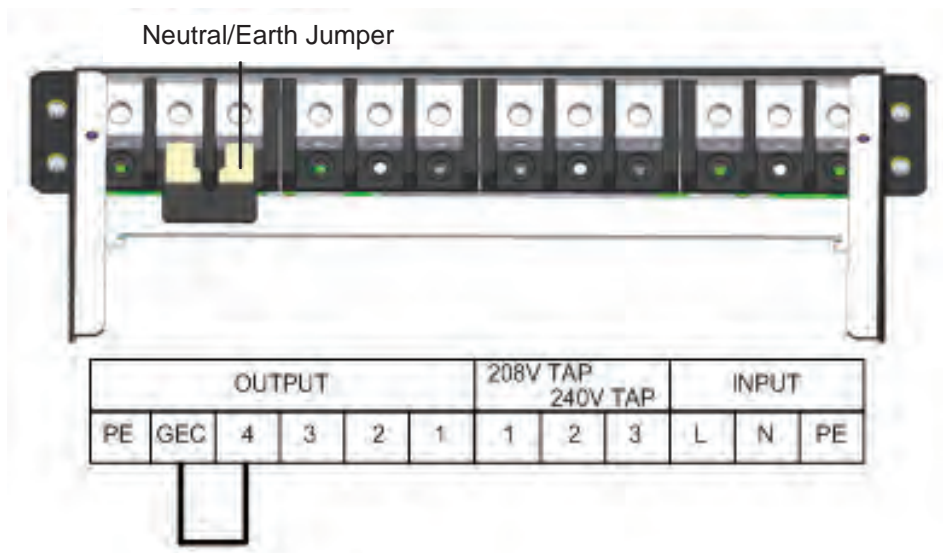
**Figure 35** Setting bypass voltage jumper (200/220/230/240VAC)



## Configuring the Neutral/Earth Jumper

The UPS contains an isolation transformer that generates a neutral conductor for the connected load. The UPS is a separately derived source and contains a neutral/earth jumper. A factory-installed neutral/earth jumper copper bar may require removal to comply with local codes and regulations.

**Figure 36** Configuring the neutral/earth jumper



## Connecting Cables

To connect the cable:

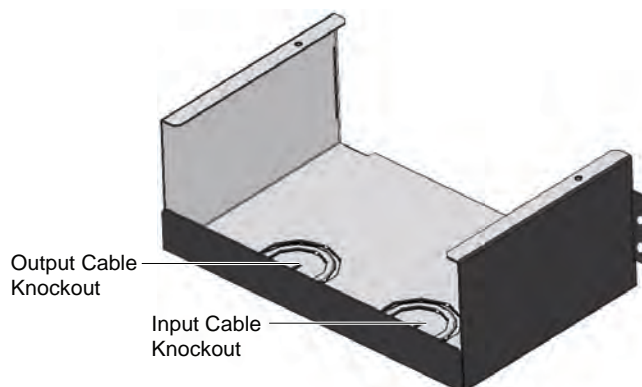


### NOTE

*Input and output cables must be run in separate conduit before cable connection.*

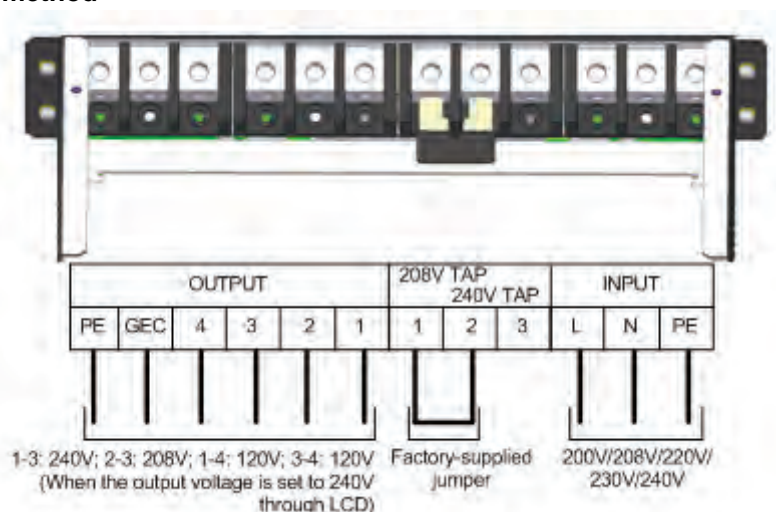
1. Remove the knockouts at the junction box (see **Figure 37**) and pull the cables through them, leaving some slack for installation.

**Figure 37** Knockouts



2. Connect the cable to the corresponding terminal of the power input and output terminals. Using a torque wrench, tighten the screws to 4.52 Nm (40 in-lb). The connections are shown in **Figure 38**.

Figure 38 Connection method



Refer to **Table 6** for configuring the output cable. For standard voltages, make the connections shown in **Table 7**.

Table 7 Configuration list for output cables

Output Voltage	Set Output Voltage by LCD	Bypass Voltage Jumper		Output Voltage (Between Terminals)			
		208V TAP (1-2)	240V TAP (2-3)	1-4	3-4	2-3	1-3
200/100	200	—	OK	100	100	173 (Do Not Use)	200
220/110	220	—	OK	110	110	190 (Do Not Use)	220
230/115	230	—	OK	115	115	199 (Do Not Use)	230
220/127	220	OK	—	127	127	220	254 (Do Not Use)
240/120	240	—	OK	120	120	208	240
208/120	208	OK	—	120	120	208	240

If the bypass voltage jumper copper bar is connected incorrectly, the system will report a fault alarm.

**Table 8** shows the maximum load capacity of the output winding of the transformer-based UPS.

Table 8 Maximum load capacity of the output winding

UPS Model	Maximum Output Capacity, kVA (Between Terminals)			
	1-4	3-4	2-3	1-3
16-bay Transformer-based UPS	10	10	20	20
10-bay Transformer-based UPS	7.5	7.5	15	15



### 2.5.3 Transformer-Free UPS—Dual Inverter Frames

A junction box is factory-installed on all models of the Liebert APS to ease cable connection.

Select the appropriate input cables according to **Tables 9** and **10** based on the UPS rating and mains frequency. Emerson recommends sizing the overcurrent protection and wiring for the frame rating for easing upgrades to the UPS system.

**Table 9 Input cable selection for Transformer-free Dual Inverter frames(50/60 Hz)**

Maximum System Rated Load	Input Voltage – 200/100VAC		Input Voltage – 208/120VAC		Input Voltage – 240/120VAC	
	Maximum Current in UPS Mode	Recommended Input Protection Circuit Breaker	Maximum Current in UPS Mode	Recommended Input Protection Circuit Breaker	Maximum Current in UPS Mode	Recommended Input Protection Circuit Breaker
5kVA	28A	50A	27A	50A	27A	50A
10kVA	56A	70A	54A	70A	54A	70A
15kVA	84A	100A	80A	100A	80A	100A
20kVA	112A	125A	107A	125A	107A	125A

The power input and output terminals accept a maximum cable cross-sectional area of 35mm<sup>2</sup> (2AWG); the minimum cable cross-sectional area is 16mm<sup>2</sup> (6AWG); and the rated torque is 4.52Nm (40 in-lb); 90°C copper wire is recommended.

**Table 10 Input cable selection for Transformer-free Dual Inverter frames(50/60 Hz)**

Maximum System Rated Load	Input Voltage – 220/110VAC		Input Voltage – 230/115VAC		Input Voltage – 220/127VAC	
	Maximum Current in UPS Mode	Recommended Input Protection Circuit Breaker	Maximum Current in UPS Mode	Recommended Input Protection Circuit Breaker	Maximum Current in UPS Mode	Recommended Input Protection Circuit Breaker
5kVA	28A	63A	28A	63A	27A	50A
10kVA	56A	63A	56A	63A	54A	70A
15kVA	84A	100A	84A	100A	80A	100A
20kVA	112A	125A	112A	125A	107A	125A

The power input and output terminals accept a maximum cable cross-sectional area of 35mm<sup>2</sup> (2AWG); the minimum cable cross-sectional area is 16mm<sup>2</sup> (6AWG); and the rated torque is 4.52Nm (40 in-lb); 90°C copper wire is recommended.

To connect the cable:

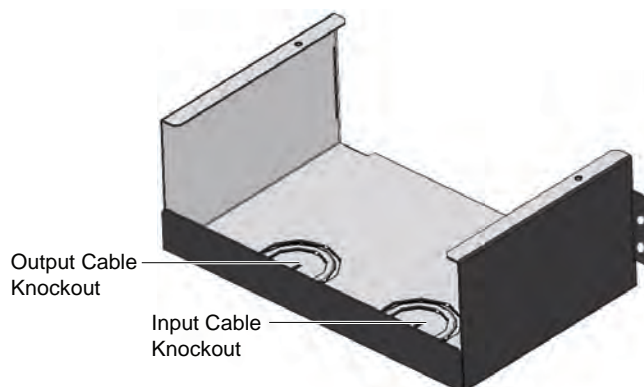


#### NOTE

*Input and output cables must be run in separate conduit before cable connection.*

1. Remove the knockouts at the junction box (see **Figure 31**) and pull the cables through them, leaving some slack for installation.

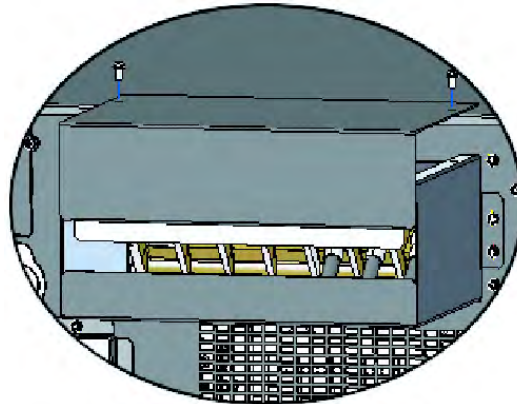
**Figure 39 Knockouts**



2. Connect the cables to the corresponding terminal of the power input and output terminals.
3. Tighten the screws to 4.52Nm (40 in-lb) with a 13mm (1/2 in) torque wrench.

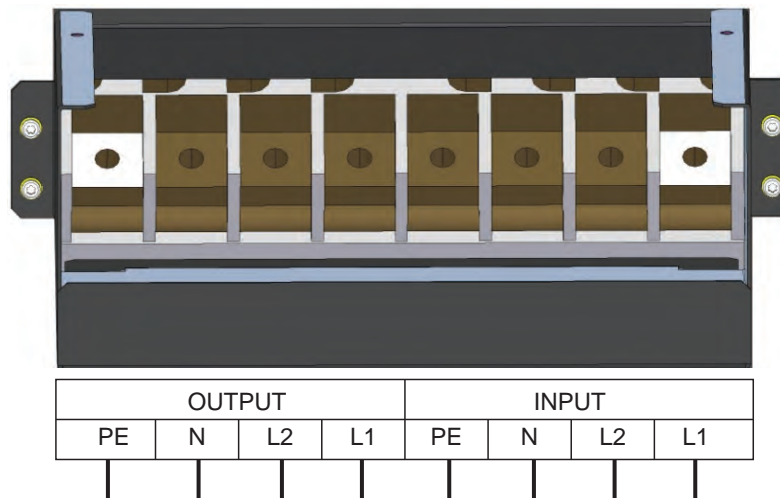
4. Respectively secure the input/output cables through the cable bridges on the rear panel of the UPS (see **Figure 40**).

**Figure 40** Secure cables on cable bridges



The connections for the single-phase input mode and the 3-phase input mode are shown in **Figure 32** and **Figure 33**, respectively. The copper jumper bus bar is essential for the single-phase input mode.

**Figure 41** Wiring connections



## 2.5.4 Connecting External Battery Cabinet

Up to four external battery cabinets may be connected to the Liebert APS to provide longer battery run times.

An external battery cabinet contains a standard battery cable and a communication cable, each 1meter (39in) long. They are used to connect UPS and the external battery cabinet. Optional cables of 3 and 5 meters can be provided if the battery cabinets must be located some distance from the UPS cabinet.

To connect an external battery cabinet:

1. Connect one end of the battery cable to the external battery connector on the rear of the UPS.
2. Connect the other end to the corresponding port on the rear of the external battery cabinet, as shown in **Figure 42** and **Figure 43**.
3. Install and tighten a grounding screw between the EBC battery cable and the UPS frame.
4. Insert a Liebert IntelliSlot EBC card into any intelligent card slot on the rear of UPS. Connect one end of the signal cable to the Liebert IntelliSlot EBC card and the other end to the Liebert IntelliSlot EBC card on the rear of the external battery cabinet, as shown in **Figure 42** and **Figure 43**.

**Figure 42** Connecting external battery cabinet to a transformer-free UPS

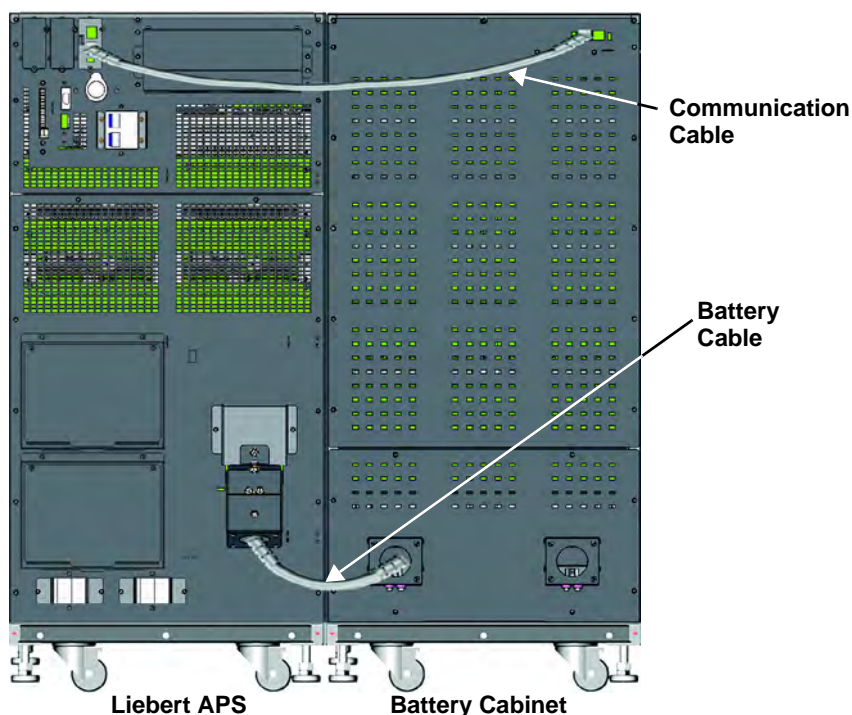
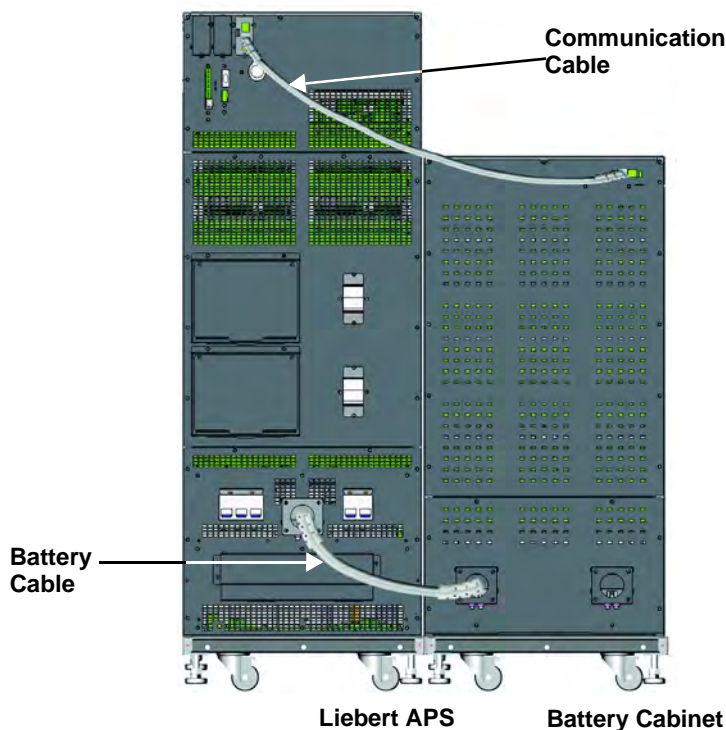
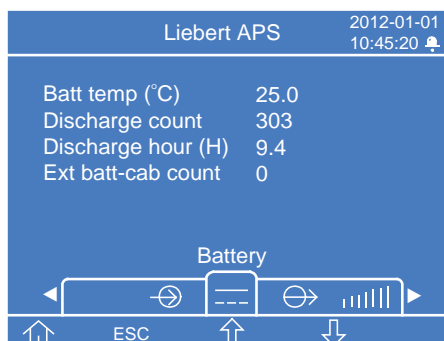


Figure 43 Connecting external battery cabinet (transformer-based UPS)



After connecting the external battery cabinet, use the user interface to determine the number of external battery cabinets, as shown in **Figure 44**.

Figure 44 Battery screen



If the number displayed is not consistent with the actual installation number of external battery cabinets:

- Ensure each external battery cabinet contains two battery modules installed on the same row and both have the locking levers in the locked position.
- Ensure the Liebert IntelliSlot EBC card is installed properly and the communication cables are fully inserted in the connectors.
- Determine that the DIP switch setting of each battery cabinet is correct using the following table

Table 11 EBC DIP switch settings

External Battery Cabinet Number	DIP Switch Setting	
	1	2
EBC #1	UP	UP
EBC #2	Down	UP
EBC #3	UP	Down
EBC #4	Down	Down

## 2.5.5 Connecting Integrated Power Output Distribution (POD)

The rear panel of the Liebert APS UPS provides the capability to add integrated distribution outlets (PODs) as an option to allow direct AC power connection of the supported equipment to the UPS. These PODs are intended to allow the user to install and even change distribution, if necessary as equipment changes, while the UPS is still providing power. Follow these steps to properly and safely add or change the optional PODs.

1. Ensure that the POD breaker is in the Off position.



### NOTE

*This is the breaker located near the POD port.*

2. Using a Phillips screwdriver, remove the two screws that are at the top of the POD cover plate and retain these for reattaching the POD.
3. Remove the POD cover plate to expose the POD connectors.
4. Insert the bottom of the POD into the slot provided, and then connect the POD connectors.



### NOTE

*The two connectors should connect only one way, matching the color of the connectors.*



### NOTE

*Distribution PODs PD2-101, PD2-102, PD2-103, PD2-104, PD2-105, PD2-106 and PD2-107 should not be used if the UPS output voltage is set to 220/127V.*

5. Secure the POD by using the two screws removed in **Step 2**.
6. Repeat **Steps 1** through **5** to install a second POD on the Liebert APS (only the 16-bay frame has two POD ports).
7. Connect the equipment to the appropriate outlets.
8. Close the POD breaker(s) to connect AC power to the outlets.
9. After commissioning the UPS, turn On the connected equipment per the manufacturer's instructions (see **2.5.6 - Commissioning/Startup Procedures**).

## 2.5.6 Commissioning/Startup Procedures

The Liebert APS can be commissioned with or without AC power being connected. Follow these steps for the initial UPS system startup:

### Checks Before Commissioning/Startup

- \_\_\_ 1. Verify that the AC power connections are wired properly and all connections are tight.
- \_\_\_ 2. If using external battery cabinets or third-party battery systems, verify that the DC power and communication cables are connected properly and all connections are tight.
- \_\_\_ 3. Measure and record the AC input voltage and frequency. This will be needed to properly configure the output voltage of the Liebert APS system.
- \_\_\_ 4. If any modules within the Liebert APS system were removed during installation, verify that all modules are fully inserted and that the module locking levers are in the locked position.
- \_\_\_ 5. If the UPS is being connected into a Remote Emergency Power Off (REPO) circuit, refer to **3.3 - REPO (Remote Emergency Power Off)** for the REPO connection details and instructions. If no REPO circuit is required or used, the factory-installed jumper must be removed from the terminal block Pins 9-10 as described in **3.2 - Dry Contact Ports**.
- \_\_\_ 6. Verify that the UPS internal bypass breaker is in the open position with the guard in place and secure.

### Commissioning/Startup with AC Power Available (Normal Mode Operation)

- \_\_\_ 1. Verify that the upstream mains AC breaker is closed.
- \_\_\_ 2. Turn On the UPS Enable switch on the rear of the unit (it is protected by a clear plastic cover).
- \_\_\_ 3. Close the UPS input breaker: it is on the front of transformer-free frame systems and on the rear of transformer-based frame systems.

**NOTE**

*This will begin the initial system checks and enable power to begin charging the battery*

- \_\_\_ 4. Press the ON/OFF button on the LCD panel.
- \_\_\_ 5. When asked to confirm, press Enter (F5 button) to turn On the UPS.
- \_\_\_ 6. Close the UPS output breaker on the rear of the unit.
- \_\_\_ 7. If supplying power to an external distribution panel, close all breakers to provide power to the equipment. If using the integral distribution PODs on the UPS or MBC, ensure the individual POD breakers are closed.

### Commissioning/Startup Without AC Power Available (Battery Mode Operation)

**NOTE**

*Starting the UPS system without AC power will discharge the batteries. If AC mains power is not restored before the batteries discharge, the USP will shutdown and power will be lost to the connected equipment. If the UPS reaches the battery EOD level and shuts down, AC mains power must be present to restart the UPS system.*

1. Check to ensure the upstream mains AC breaker is closed.
2. Turn on the UPS “Enable” switch on the rear of the unit.
3. Locate the “Battery Start” push button that is on either of the two control modules. Press and hold this button for 5 seconds.

**NOTE**

*This will begin the initial system checks and automatically enable output power.*

4. Close the output breaker on the rear of the Liebert APS.
5. If supplying power to an external distribution panel, close all breakers to provide power to the equipment. If using the integral distribution PODs on the UPS or MBC, verify that the individual POD breakers are closed.
6. Emerson recommends closing the UPS input breaker; it is on the front of transformer-free frame systems and on the rear of transformer-based frame systems. If AC mains becomes available, the UPS will revert to AC power mode and begin recharging the battery.

## 3.0 COMMUNICATION

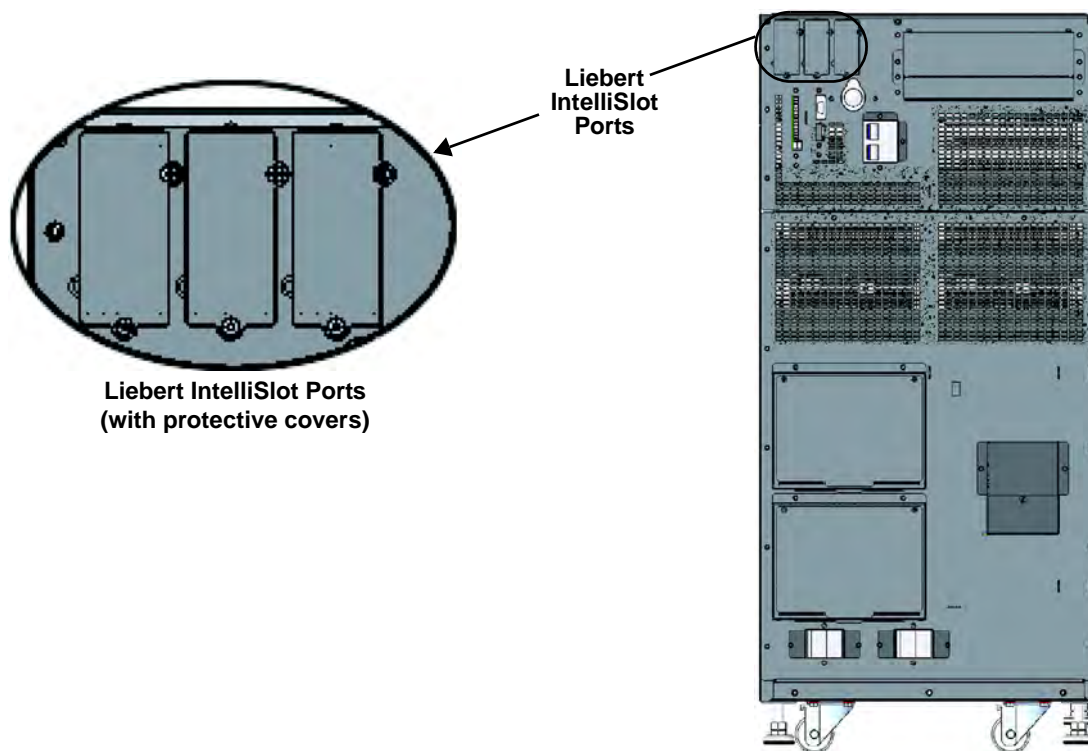
The rear panel of the Liebert APS provides these communication ports:

- Liebert IntelliSlot® ports—3
- Dry contact ports—1
- REPO (Remote Emergency Power Off)—1
- Long Run Time (LRT) Battery Temperature Probe Terminals—1
- USB port—1

### 3.1 Liebert IntelliSlot Ports

The three Liebert IntelliSlot communication ports (see **Figure 45**) are used for installing communication options, including the Liebert IntelliSlot Unity card, dry contact card, Liebert MultiPort and Liebert IntelliSlot EBC card. The Liebert IntelliSlot ports and the USB port can be used at the same time.

**Figure 45 Liebert IntelliSlot communication port location**



#### Liebert IntelliSlot Unity Cards—IS-UNITY-LIFE, IS-UNITY-S, IS-UNITY-DP

- **IS-UNITY-LIFE:** This card is standard in every Liebert APS. It is used for communication between the Liebert APS UPS and Emerson's Trellis® NMS and LIFE Services.
- **IS-UNITY-S:** This optional card can be used instead of the standard card if communication to a third party platform is required. Third-party platforms include SNMP or 485 (Modbus/Bacnet) protocols. This card would still be used for communication between the Liebert APS and Emerson's Trellis NMS and LIFE Services. All communication protocols are active simultaneously.
- **IS-UNITY-DP:** This optional card can be used instead of the standard card if communication to two third-party platforms is required. Third-party platforms include SNMP and 485 (Modbus/Bacnet) protocols. This card would still be used for communication between the Liebert APS UPS and Emerson's Trellis NMS and LIFE Services. All communication protocols are active simultaneously.

### Liebert IntelliSlot® Dry Contact Card (IS-RELAY)

Provides dry contact alarm information, including: On Battery, On Bypass, Low Battery, Summary Alarm, UPS Fault and On UPS signals for communication to a remote monitoring system or for use with Liebert MultiLink® software. This card also can accept input signals to shut down the UPS while it is in any mode of operation.

### Liebert IntelliSlot MultiPort Card (IS-MULTIPOINT)

Provides dry contact alarm information, including: On Battery, Low Battery signals for communication to four servers for use with Liebert MultiLink software.

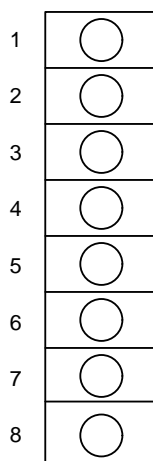
### Liebert IntelliSlot EBC Card

This card is used for the Liebert APS UPS to monitor and manage the intelligent battery modules in external matching battery cabinets.

## 3.2 Dry Contact Ports

The UPS provides dry contact ports. See **Figure 1** for location and **Figure 46** for the pin layout.

**Figure 46** Pin layout of the dry contacts



**Table 12** shows the pin definition of each dry contact port.

**Table 12** Pin definition of dry contact port

Position	Name	Description
1	Battery Mode	Output dry contact of battery mode operation
2	Battery Mode	Output dry contact of battery mode operation
3	Low Battery	Output dry contact of low battery operation
4	Low Battery	Output dry contact of low battery operation
5	Any Mode Shut Down	Input dry contact of any mode shut down
6	GND	Any mode shutdown GND
7	Battery Mode Shut Down	Input dry contact of battery mode shut down
8	GND	Battery mode shutdown GND

#### Battery Mode Dry Contact

**Pins 1 and 2:** Output dry contact, normally open. The dry contact is closed when the UPS is operating on battery. The maximum voltage and current are 24VDC and 0.3A, respectively.

#### Low Battery Dry Contact

**Pins 3 and 4:** Output dry contact, normally open. When the UPS is operating on battery, the dry contact is closed upon battery low voltage alarm. The maximum voltage and current are 24VDC and 0.3A, respectively.



### Any Mode Shut Down

**Pins 5 and 6:** Input dry contact, normally open. After the external dry contact is closed (shorted), the UPS output will be shut down during any mode of operation (mains, battery, bypass).

### Battery Mode Shut Down

**Pins 7 and 8:** Input dry contact, normally open. After the external dry contact is closed (shorted), the UPS output will be shut down only during battery mode operation.



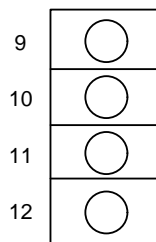
**NOTE**

*The default for the Any Mode and Battery Mode Shutdown features is disabled. Using this function requires setting Remote comms shutdown to Enabled in the Settings through the LCD. Additionally, the shutdown delay can be accessed in the LCD Settings to set the delay time for the UPS shutdown after the dry contact is closed. Enabling the feature on the LCD enables both shutdown methods.*

### 3.3 REPO (Remote Emergency Power Off)

The Liebert APS is equipped with a REPO (Remote Emergency Power Off) connection. Only the SELV (Safety Extra Low Voltage) circuit can be connected to the REPO terminal block. **Figure 48** shows the REPO connection pin layout. See **Table 13** for the pin definition.

**Figure 47 REPO connector pin layout**

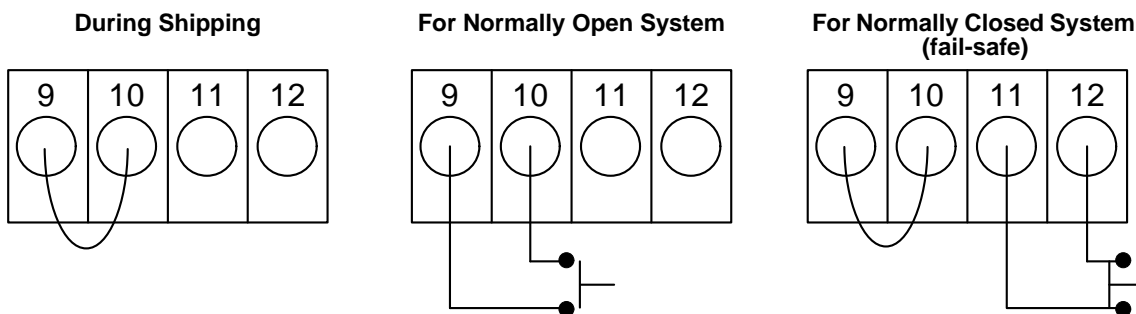


**Table 13 Pin definition of the REPO dry contact**

Position	Name	Description
9	REPO +12V	REPO power, 12VDC 100mA
10	REPO Coil -NO	REPO normally open nodes, shorting pins 9 and 10, REPO is triggered
11	REPO Coil -NC	REPO normally closed nodes (fail-safe), shorting pins 9, 10, 11, 12, and opening pins 11 and 12, REPO is triggered
12	GND	GND

**Figure 47** shows the schematic diagram of REPO switch connections.

**Figure 48 REPO switch connections**



## **WARNING**

Risk of electrical shock. Can cause property damage, injury and death.

Operating the REPO circuit will NOT trip the manual bypass breaker. If the REPO must shut off UPS output under all circumstances, the user must tie the REPO into the breaker feeding the UPS source. Otherwise, voltage may be present on the output connections if the unit is in manual bypass.

## **NOTICE**

Risk of improper installation. Can cause unintended UPS shutdown and loss of power to the load.

Run signal cables separately from power cables. Running cables in the same conduit can cause signal noise, possibly causing the system to shut down.



### **NOTE**

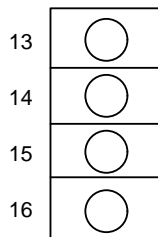
*A jumper is factory-installed between Pins 9 and 10 to disable the Main Control Switch. This will prevent the UPS from being started accidentally during shipment and installation. This jumper must be removed before the unit can be started.*

*If the installation does not require connection to a REPO system, the factory-installed jumper must be removed.*

### **3.4 Long Run Time (LRT) Battery Temperature Probe Terminals**

The Liebert APS contains a temperature-compensated battery charging system. To use this feature with external LRT battery systems, Pins 13-16 of the contact terminal strip are used to connect a temperature sensor. See **Figure 49** and **Table 14** for the pin definition of the temperature sensor terminals.

**Figure 49 Pin layout of the temperature sensor terminal**



**Table 14 Pin definition of the temperature sensor terminal**

Position	Name	Description
13	Inside Battery Temperature	Locate battery temperature signal close to the UPS
14	Battery Temperature +12V	Battery temperature signal power supply
15	Outside Battery Temperature	Locate battery temperature signal at UPS remote end
16	GND	GND

### **3.5 USB Port**

The Liebert APS UPS contains a standard B type USB port on the rear of the unit to connect the UPS to a network server or other computer for monitoring using any operating system, built-in UPS support or in conjunction with Liebert MultiLink® software.

### 3.6 Liebert MultiLink®

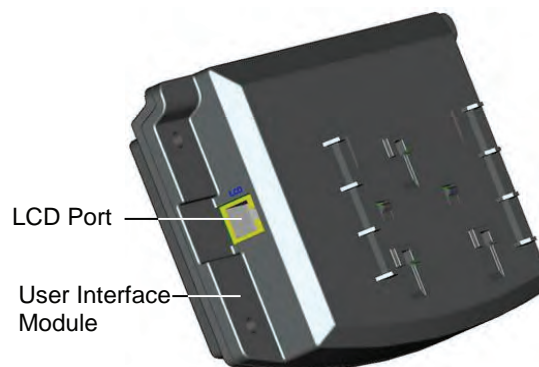
Liebert MultiLink monitors the UPS continuously and can shut down configured computers in the event of an extended power failure. Liebert MultiLink can also be configured to shut down the UPS. Liebert's MultiLink can also be configured for use without the USB cable when the Liebert IntelliSlot® UNITY-S or UNITY-DP SNMP Card is installed in the UPS. An optional Liebert MultiLink License Kit permits shutting down the UPS over a network. For more information about the Liebert IntelliSlot SNMP Card, Liebert IntelliSlot Web Card and Liebert MultiLink license kits, visit <http://multilink.liebert.com> or contact your local Emerson representative.

### 3.7 LCD Port

The LCD module contains the LCD port, which is used for power and data communication between the UPS monitor module and display module. The LCD module can be removed from the Liebert APS and remotely located. A longer Ethernet cable must be used when installing the LCD module remotely. A standard Ethernet (Category 5, with RJ-45 connectors, both ends meet T568B standard) type cable can be used. Maximum cable length is 14 meters to ensure proper communication signals between the UPS and the LCD module.

The user interface module provides three network ports and one USB port. Of those, one network port (LCD port) is used for power supply and communication of the user interface module. Other network ports and the USB port are reserved for use only by customer service personnel.

**Figure 50** LCD port

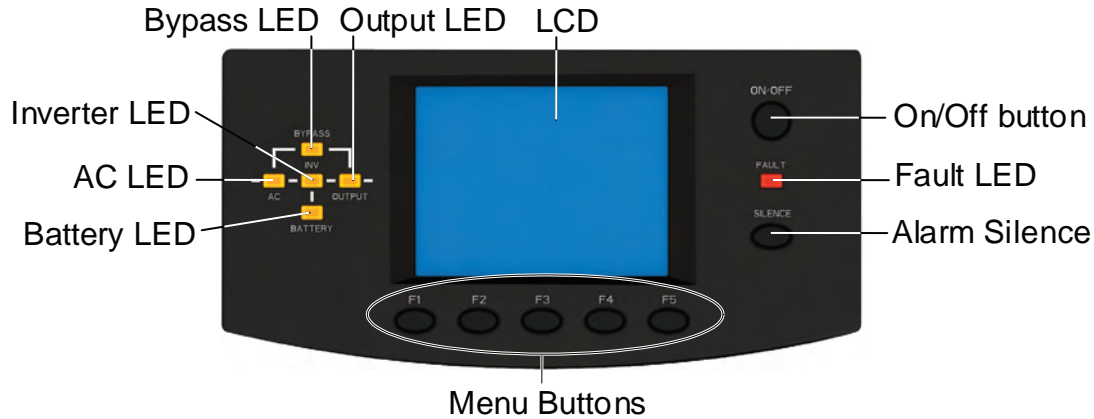


## 4.0 OPERATION AND DISPLAY PANEL

### 4.1 Overview

This chapter describes the functions and operation of the UPS display panel. The LCD is composed of an LED mimic power flow diagram, fault LED indicator and LCD screen to show detailed operational information and UPS alarm list using the navigation buttons. For location and information about the display panel, refer to **Figure 51** below

**Figure 51** Operation and display panel



#### Mimic LEDs

The mimic power flow LEDs indicate current operating state of the UPS. The state descriptions of the LEDs are given in **Table 15**.

**Table 15** LED descriptions

LED	State	Description
AC LED	On (Green)	The rectifier is functioning normally
	Flashing (Green)	The AC mains is normal, but the rectifier is not functioning properly
	On (Red)	The rectifier is faulty
	Off	The AC mains is abnormal, and the rectifier is not functioning
Battery LED	On (Green)	The battery is discharging
	Flashing (Green)	The battery has a pre-alarm of low voltage
	On (Red)	The DC-DC converter is faulty
	Off	The battery is charging, and the DC-DC converter is not functioning
Bypass LED	On (Green)	The bypass is supplying power
	On (Red)	The bypass is abnormal and not available
	Off	The bypass is normal, but not supplying output power
Inverter LED	On (green)	The inverter is supplying output power
	Flashing (green)	The inverter is starting up, in soft start or phase locked, and is not supplying output power
	On (red)	The inverter is faulty
	Off	The inverter is off
Output LED	On (green)	The UPS output is supplying power
	Flashing (green)	The UPS internal manual bypass is supplying output power
	On (red)	The UPS has output overload
	Off	The UPS does not have output power
Fault LED	On (yellow)	The UPS has an alarm or alarms
	On (red)	The UPS has one or more faults
	Off	UPS operating normally with no alarm or fault conditions

### Audible Alarms

Three different audible alarms may occur during the UPS operation; see **Table 16** for a description of the audible alarms.

**Table 16 Audible alarm descriptions**

Alarm sound	Meaning
One beep per second	When the UPS has an alarm, for example, AC fault (mains failure)
One beep every 0.5 second	Upon UPS output overload or low battery voltage alarm during discharge
Continuous beep	When the UPS has a fault

### Control Buttons

The operation and display panel provides two control buttons. See **Table 17** for their function descriptions.

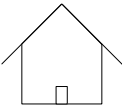





**Table 17 Control buttons functions**

Control Button	Function
ON/OFF Button	Used to turn the UPS On and Off.
Alarm Silence Button	When an audible alarm sounds, pressing this button can silence the alarm. Pressing this button again can restart the audible alarm.

### LCD and Menu Buttons

The operation and display panel provides an LCD screen and five menu buttons (F1, F2, F3, F4, F5). See **Table 18** for the function description of each menu button.

**Table 18 Function descriptions of menu button**

Button	F1	F2	F3	F4	F5
Function 1	 HOME	—	 To Left	 To Right	 Enter
Function 2	—	ESC Exit	 Up	 Down	—

The LCD is a 320 × 240 dot matrix graphic display. Through the LCD interface and the easily operated menu, you can browse the UPS input, output, load and battery parameters and obtain the current state and alarm information of the UPS. You also can perform relevant function/parameter settings and control operations.

**Figure 52 User interface module layout**



## 4.2 LCD Screen

### 4.2.1 Startup Screen

When the UPS starts up, it will conduct a self-test, and the LCD will display the startup screen, which lasts for 15 seconds as shown in **Figure 53**.

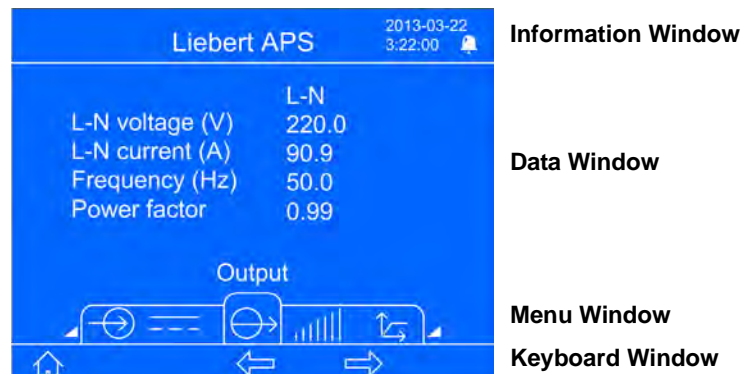
**Figure 53** Startup screen



### 4.2.2 Main Screen

The main screen is divided into four parts: system information window, data window, menu window and keyboard window, as shown in **Figure 54**.

**Figure 54** Main screen



The functions of F1 ~ F5 buttons will change automatically according to the currently-displayed screen. On any screen, pressing the F1 button will return to the Output screen.

### System Information Window

The system information window displays the current time and the UPS name without requiring user intervention. See **Table 19** for the detailed description.

**Table 19** Item description of system information window

Item	Description
Liebert APS	UPS name, representing Liebert APS
2012-01-01 10: 45: 20	Current time (format: year-month-date) (format: 24 hours, h: m: s)

## Menu Window and Data Window

The menu window shows the menu name and allows navigation to different menu items. Each menu item has a set of data that is displayed in the data window. Using the menu window, you can browse the relevant parameters of the UPS and can adjust/set some operational parameters. See **Table 20** for the menu and data descriptions.

**Table 20** Item description of menu window and data window

Menu Name	Data Item	Data Description
Mains	L-N Voltage (V)	L-N input voltage
	L-N Current (A)	L-N input current
	Frequency (Hz)	Input frequency
	L-L Voltage (V)	L-L input voltage
	kVA	Input apparent power
	Power Factor	Input power factor
Battery	Batt Voltage (V)	Battery bus voltage
	Batt Current (A)	Battery bus current
	Remaining Time (Min.)	Battery backup time remaining
	Batt Capacity (%)	Percentage of battery capacity
	Batt State	Charging, discharging or fully charged
	Batt String Count	Online battery string count
	Batt Temp (°C)	Battery temperature
	Discharge Count	Maximum historical discharge count within current battery modules
	Discharge Hour (H)	Maximum historical discharge time within current battery modules
	Ext Batt-cab Count	Number of connected External Battery Cabinets
Output	L-N Voltage (V)	L-N Output Voltage
	L-N Current (A)	L-N Output Current
	Frequency (Hz)	Output Frequency
	Power Factor	Output Power Factor
	Line Voltage (V)	L-L Output Voltage (not displayed for single-phase output model)
Load	kVA	Output apparent power
	kW	Output active power
	Load Level (%)	Output loading, indicated in percentage of the UPS system rated load
	Crest Factor	Output current peak value factor
UPS Info.	UPS ID	UPS ID
	LCD Module	If the module is online, the serial number and software version will be displayed
	Monitor Module	If the module is online, the serial number and software version will be displayed
	Control Module	If the module is online, the serial number and software version will be displayed
	Charger Module	If the module is online, the serial number and software version will be displayed
	Power Module	If the module is online, the serial number and software version will be displayed
	Battery Module	If the module is online, the serial number and software version will be displayed
Redundant State	PM Installed	The number of installed power modules
	PM	Whether there are redundant power modules supplying power.

**Table 20 Item description of menu window and data window (continued)**

Menu Name	Data Item	Data Description
Settings	Redundancy	Disabled/ Enabled. If 'Enabled,' the system operational parameters will assume there is a redundant power module in the frame; if 'Disabled', the system operational parameters will assume that all power modules in the frame are not redundant. Note: This item is closely related to the 'Redundant alarm' setting
	Remote Shutdown Through Comms Ports	Disabled/ Enabled. If 'Enabled,' this allows the UPS output power to be shutdown through remote communication, including the dry contacts and Liebert IntelliSlot communication cards. Note: This item is closely related to 'Remote shutdown delay'
	Bypass Set	Enables the bypass to supply power or not
	Output Frequency	Sets the output frequency to allow frequency conversion operation
	Output Voltage	Sets the output voltage level to match the mains input voltage
	Sync Range	Sets the range of inverter synchronization for bypass frequency operation and availability
	Shutdown Delay	Sets the shutdown delay time for the remote signal operation
	Bypass Upper Limit	Sets the upper limit of bypass voltage operation and availability
	Bypass Lower Limit	Sets the lower limit of bypass voltage operation and availability
	Guaranteed Shutdown	Disabled/ Enabled. If 'Enabled,' once a low battery alarm is generated during a battery discharge, the UPS will continue battery mode operation until it reaches the end of discharge (EOD) setpoint, then will shutdown output power, whether the AC mains recovers or not.
	Bypass Alarm Mode	Allows an alarm to be generated when the bypass is abnormal
	Serial Comm. Select	Because the slot 2 and the serial port on the rear panel cannot work at the same time, you must select one of them to work. If 'INTERFACE2' is selected, the slot 2 can communicate; if 'RS232' is selected, the serial port can communicate.
	Auto Restart Mode	Allows auto restart after a EOD shutdown and AC mains returns
	Auto Restart Capacity	Sets the battery capacity limit of auto restart feature. When AC mains power returns, the UPS will charge the battery to the specified battery capacity before enabling output power.
	Auto Restart Delay	Sets the delay time of auto restart feature. When AC mains power returns, the UPS will start a countdown timer based upon the setting before enabling output power.
	Display Contrast	Adjusts the contrast of LCD backlighting
	Date and Time	Sets date and time
	Control Password	Users can change the control password to prevent unauthorized user from changing any user configurable settings. The default password is 1234567. Once the password is changed, the default password is no longer operational and users are then required to enter the new password to enter/change any 'Settings' or 'Battery settings'. If the new password is forgotten, contact your local customer service center for steps to reset the password back to the factory default.
Max Load Alarm	Sets a maximum load alarm. This item is closely related to 'Max load threshold.'	
Max Load Threshold	Sets the threshold of maximum load alarm. When the UPS loads exceed the threshold, and the maximum load alarm is enabled, an alarm will be generated. This item is closely related to 'Max load alarm,' for example, set this item to 5.0kVA, when the UPS loads exceed 5.0kVA, an alarm will be generated.	
Redundant Alarm Mode	Allows alarm to be generated when the system loses redundant power module	



**Table 20** Item description of menu window and data window (*continued*)

Menu Name	Data Item	Data Description
Settings (continued)	Load factory default	Restore all settings in 'Settings' menu back to factory default values
	Communication Address	Sets the UPS device address. This setting is only for the network card communication of newly emerging market.
	Air filter reminder	Set the reminder period of checking dust-proof filter
	UPS ID	Users can set the UPS name to facilitate managing the UPS through remote communications
	Company name	Set the local service company name of the UPS
	Contact number	Set the local service telephone number of the UPS
Battery settings	Low battery Warning	Sets the battery low voltage alarm time
	Automatic Battery Test Interval	Sets the interval for the automatic battery test. Intervals of 8, 12, 16, 20, 26 weeks or Disable are available for selection. Factory default is 8 weeks.
	Auto Batt Test Start Day	Sets the day of the week for the automatic battery test
	Auto Batt Test Start Time	Sets the time of the day for the automatic battery test
	External Battery AH	Sets the AH capacity of external third party battery system to calculate the battery capacity and estimate the battery time remaining
	Load Factory Default	Restores the setting items in 'Battery set' menu to factory values
Language	Language Options	Provides a selection of seven languages: Chinese, English, French, Spanish, Italian, Russian and German
Alarms	Current Alarms	Displays the current alarms. See <b>Table 23</b> for the UPS alarm list
Records	Historical Alarms	Displays all historical alarms. See <b>Table 23</b> for the UPS alarm list
Module replacement	LCD Module	Displays the procedures for replacing LCD module
	System Monitor Module	Displays the procedures for replacing system monitor module
	System Control Module	Displays the procedures for replacing system control module
	Power Module	Displays the procedures for replacing power module
	Battery Module	Displays the procedures for replacing battery module
	Charger Module	Displays the procedures for replacing charger module

**Table 20** Item description of menu window and data window (*continued*)







Menu Name	Data Item	Data Description
Service	Battery Maintenance Test	Battery maintenance test allows battery to discharge some voltage to obtain the battery activity. The loads must be within 0% ~ 90%, the battery capacity must be larger than 70%, and there is no battery fault and alarm in the system.
	Stop Battery Test	Stops battery maintenance test
	System Test	A UPS self-test, used to test whether the LEDs are normal. When you start this function, 5 seconds later, the screen will prompt a window to display the system self-test result.
	Stop Testing	Stops system test manually
	Freshening Charge	Boost charges the battery by force, manually
	Stop Freshening Charge	Stops freshening charge manually
	UPS ID	Allows customer service personnel to set the UPS ID, to facilitate maintenance
	Site ID	Allows customer service personnel to set the UPS address, to facilitate maintenance
	Tag Number	Allows customer service personnel to set the UPS tag, to facilitate maintenance
	Company Name	Allows customer service personnel to set the UPS company name, to facilitate maintenance
	Contact Number	Allows customer service personnel to set the UPS company contact number, to facilitate maintenance
	Frame S/N	Reset this when replacing the LCD board. The frame S/N is labeled on the frame.
	Normal Mode	Allows customer service personnel to set the UPS operating mode to normal online mode
	ECO Mode	Allows customer service personnel to set the UPS operating mode to ECO mode

The Service screen is only for customer service personnel; it is not open to the user.

**Keyboard Window**

For the functions of the menu buttons (F1 ~ F5) in the keyboard window, see **Table 21**

**Table 21** Function descriptions of menu buttons

Button	F1	F2	F3	F4	F5
Function 1	 HOME	—	 To Left	 To Right	 Enter
Function 2	—	ESC Exit	 Up	 Down	—

### 4.2.3 Default Screen/Screen Saver

During the UPS operating process, if there are no active alarms, the LCD will go into a screen saver mode after 2 minutes of no user navigation activity. The default screen saver is shown in **Figure 55**. After a brief delay, the LCD backlight will also turn Off. Pressing any button will return to the original screen.

**Figure 55** Default screen/screen saver



## 4.3 LCD Screen Views

This section gives a detailed description of each display screen and its contents. The default “main screen” is the Output menu and its data. The navigation indicated for each screen below is in reference to the Output screen.

### 4.3.1 AC Mains Screen

From the main screen, press the F3 button twice, until the AC mains screen is displayed, as shown in **Figure 56**.

**Figure 56** Mains screen

Liebert APS		2012-01-01 10:45:20		
	L1	L2	L3	
L-N voltage (V)	220.0	220.0	220.0	
L-N current (A)	30.3	30.3	30.3	
Frequency (Hz)	50.00	50.00	50.00	
L-L voltage (V)	380.0	380.0	380.0	
kVA	6.67	6.67	6.67	
Power factor	1.00	1.00	1.00	

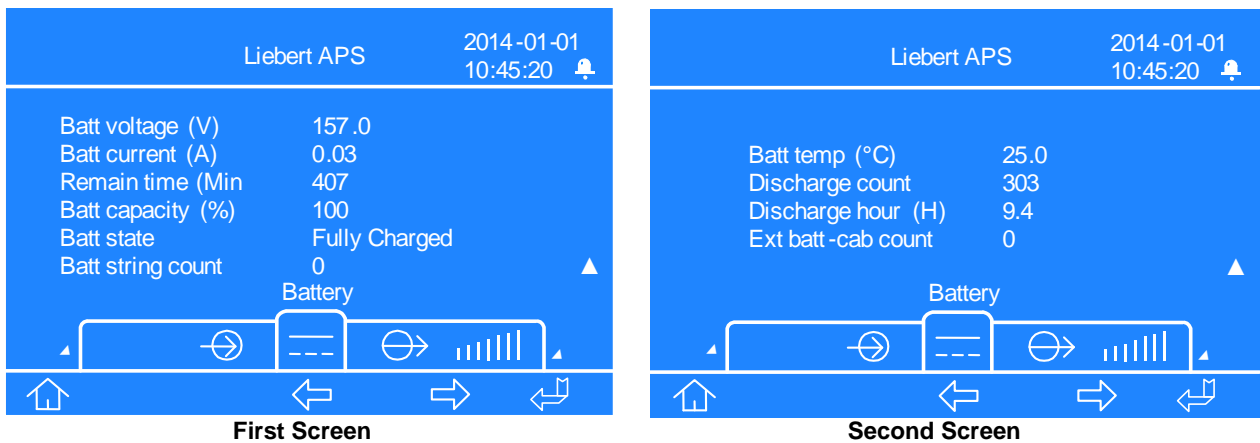
Mains

The AC mains screen displays the input L-N voltage, L-N current, input frequency, L-L voltage, apparent power and power factor of three phases (L1, L2, L3).

### 4.3.2 Battery Screen

From the main screen, press the F3 button once and the battery screen will be displayed, as shown in **Figure 57**.

**Figure 57 Battery screens**



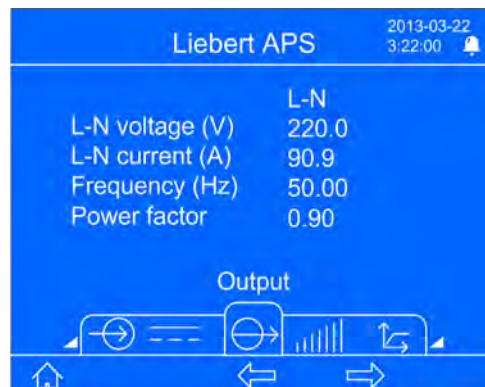
On the first battery screen, pressing the F5 button will change the function of the F2, F3, and F4 buttons from the primary functions to the secondary functions, as shown above in **Table 21**.

The battery screen displays Battery voltage, Battery current, Battery time remaining, Battery capacity, Battery state, Battery string count, Battery temperature, cumulative discharge count (highest of all installed battery modules), cumulative discharge time (in hours) and External battery cabinet count.

### 4.3.3 Output Screen

The main screen is the output screen by default, as shown in **Figure 58**.

**Figure 58 Output screen**

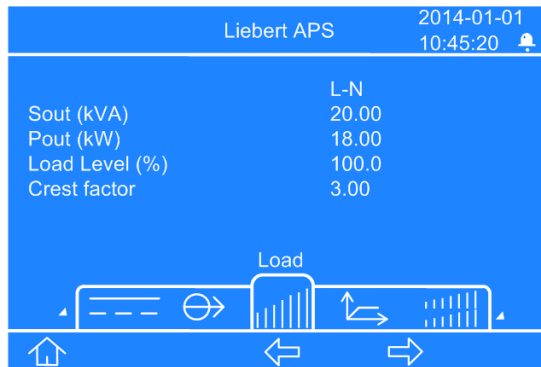


The output screen displays L-N or L-L voltage, L-N or L-L current, Frequency and Power factor.

### 4.3.4 Load Screen

From the main screen, press the F4 button once and the load screen will be displayed, as shown in **Figure 59**.

**Figure 59** Load screen

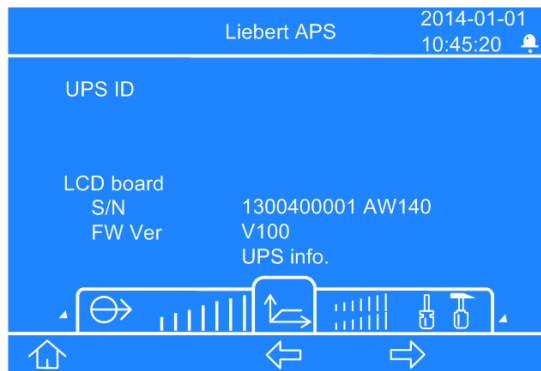


The load screen displays output kVA (Sout/apparent power), output kW (Pout/active power), load level and crest factor.

### 4.3.5 UPS Information Screen

From the main screen, press the F4 button twice until the UPS info screen is displayed as shown in **Figure 60**

**Figure 60** UPS info screen

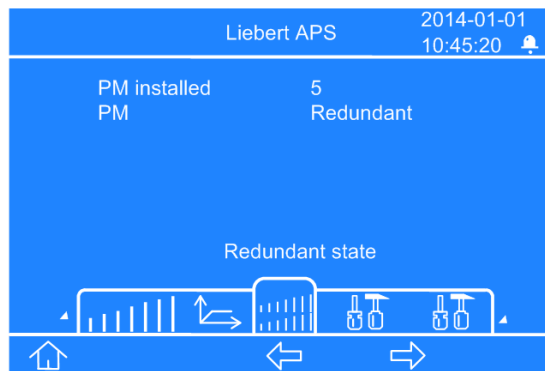


The UPS information screen displays UPS ID (name set by user), serial number and software version of LCD module, system monitor module, system control module, charger module, power module and battery module (if the modules are installed and are online).

### 4.3.6 Redundancy Screen

From the main screen, press the F4 button three times until the redundancy screen is displayed, as shown in **Figure 61**.

**Figure 61** Redundancy screen



The redundant screen displays the number of installed power modules in the frame, and whether the system contains a redundant module or not.

### 4.3.7 Settings Screen

From the main screen, press the F4 button four times until the settings screen is displayed. The settings screen is displayed in a total of nine screens as you scroll down, as shown in **Figure 62**.

**Figure 62 Settings screens**

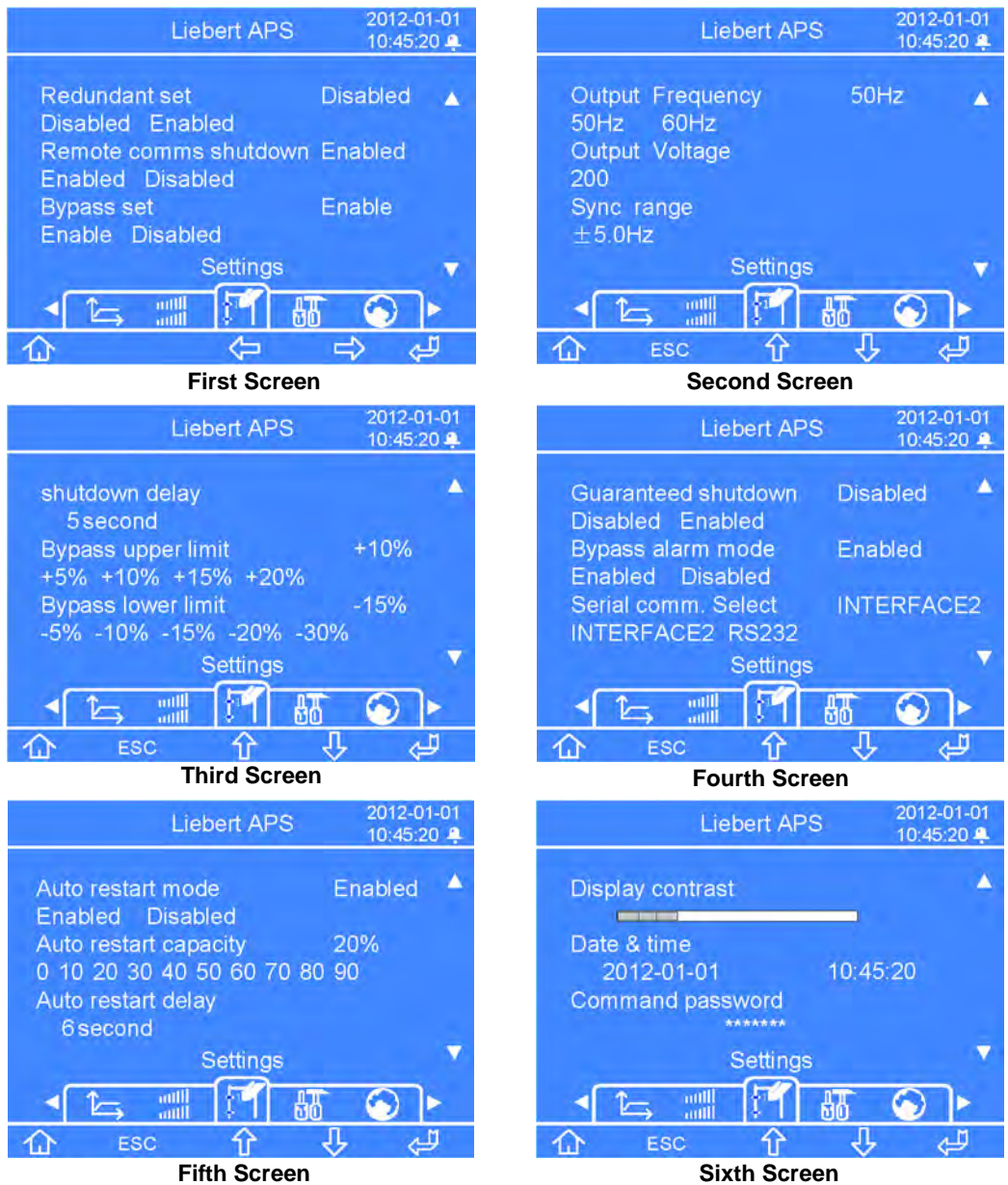
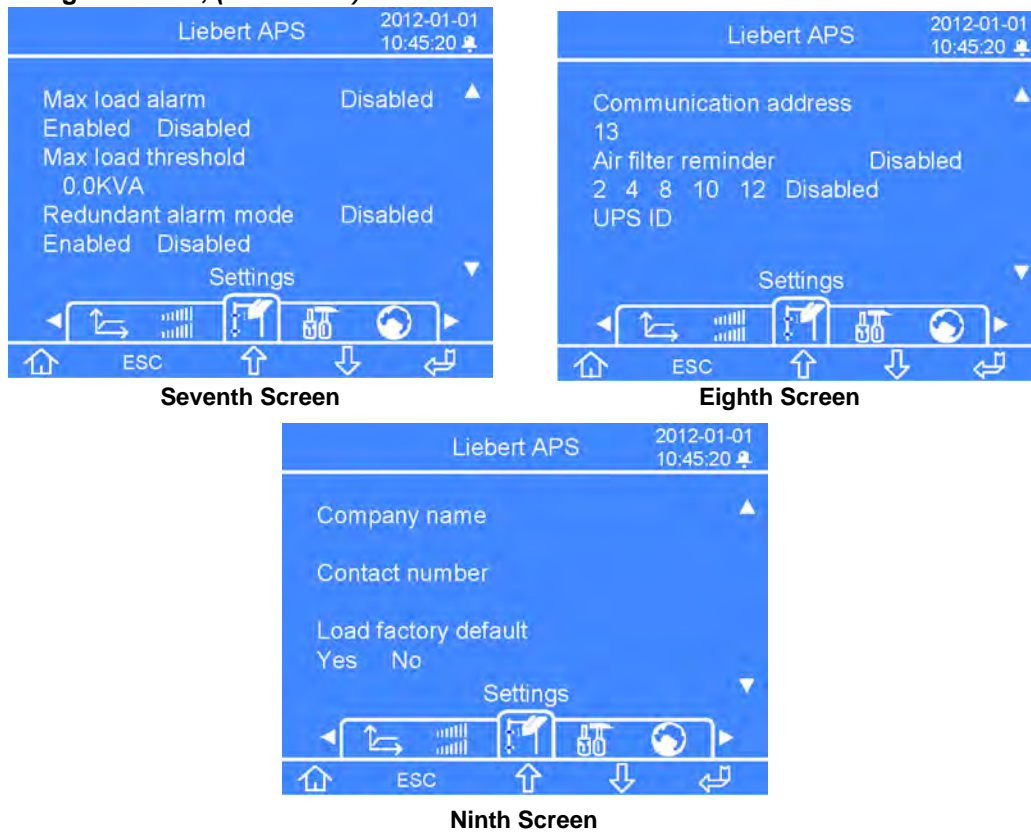


Figure 63 Settings screens, (continued)



On the first settings screen, pressing the F5 button will prompt a password window to pop up. After you enter the correct password, the function of the F2, F3, and F4 buttons will switch from the primary functions to the secondary functions, as shown above in **Table 21**.

#### 4.4 Entering a Password

1. On the password prompt window, press the F5 button, the first digit will become editable, press the F3 button to enter the correct number.
2. Press the F4 button, the second digit will become editable, press the F3 button to enter the correct number.
3. Enter the rest of the password digits using the same method in Step 2, and press the F5 button when complete.

#### 4.5 Setting or Changing a Parameter Setting

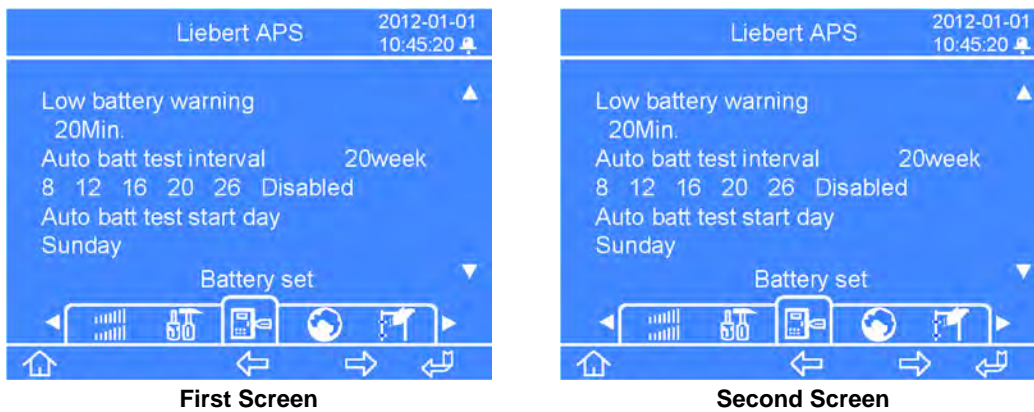
1. Press the F4 button to navigate to the parameter to be set, and press the F5 button to enter the edit mode.
2. Press the F3 or F4 button to select the setting item or change the setting value, then press the F5 button to confirm the setting. Press the F2 button to exit the edit setting mode.



### 4.5.1 Battery Setting Screen

From the main screen, press the F4 button five times until the battery settings screen is displayed, as shown in **Figure 64**.

**Figure 64** Battery settings screens



On the first settings screen, pressing the F5 button will prompt a password window to pop up. After you enter the correct password, the function of the F2, F3, and F4 buttons will switch from the primary functions to the secondary functions as shown above in **Table 21**. Refer to the notes listed above in section 4.3.7 for entering the password and making changes to the battery setting parameters.

### 4.5.2 Language Selection Screen

From the main screen, press the F4 button six times until the language screen is displayed, as shown in **Figure 65**.

**Figure 65** Language selection screen



The language selection screen displays a choice from seven languages: Chinese, English, German, Russian, French, Italian and Spanish.

**NOTE**  
*The languages are displayed in their alphabet.*

To set the language:

1. Press the F5 button, the language option is highlighted.
2. Press the F3 or F4 button to navigate to the desired language.
3. Press the F5 button to confirm the selection. Once the screen language changes, press the F2 button to exit the language setting mode.

### 4.5.3 Alarms Screen

From the main screen, press the F4 button seven times until the alarms screen is displayed, as shown in **Figure 66**.

**Figure 66** Alarms screen



The alarms screen displays any current alarms of the UPS, including the alarm name, alarm ID code and alarm date/time stamp.

### 4.5.4 Records Screen

From the main screen, press the F4 button eight times until the records screen is displayed, as shown in **Figure 67**.

**Figure 67** Records screen

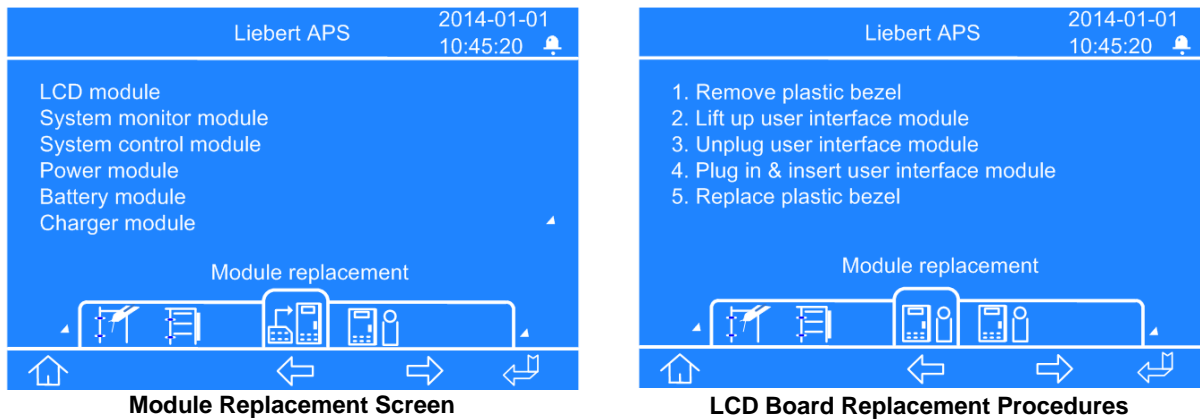


The records screen displays all historical alarms of the UPS, including the alarm name, alarm ID code, alarm date/time stamp and record number/total record count.

### 4.5.5 Module Replacement Screen

From the main screen, press the F4 button nine times until the module replacement screen is displayed, as shown in **Figure 68**.

**Figure 68** Module replacement screen



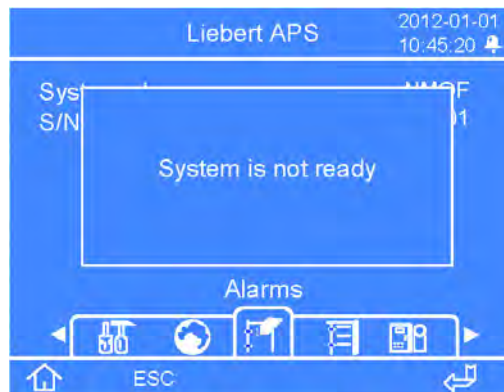
The module replacement screen displays the procedures for replacing all user replaceable module assemblies in the UPS frame.

To view the procedure, press the F5 button to enter the module replacement. One module option is highlighted. Press the F3 or F4 button to navigate to the specific module procedures, and then press the F5 button to view the procedures. Once completed, press the F2 button to exit.

### 4.5.6 Prompt Window

During system operation, occasionally the UPS system needs to alert or remind the user of alarm notifications or require the user to confirm a command or perform other operations. When this occurs, a prompt window will pop up, as shown in **Figure 69**. Refer to **Table 21** below for possible prompts and the descriptions/actions to be taken.

**Figure 69** Example of prompt window



**Table 22 Information and actions required for the prompt window**

Prompt Window	Description/Action Required
Turn On the UPS or cancel	Press the ON/OFF-button while UPS is off
Turn On the Inverter or Turn Off the output	Press the ON/OFF-button while UPS is operating in bypass mode
Turn Off the Inverter or cancel	Press the ON/OFF-button while UPS is operating in inverter mode and bypass is qualified
Turn Off the UPS or cancel	Press the ON/OFF-button while UPS is operating in inverter mode and bypass is not qualified
System self-test finished, everything is OK	No action required
System self-test finished, please check the current warnings	Check the active alarm messages
Enter control password	After the control password is changed, users are required to enter the password to enter 'Settings' and 'Battery setting' screens
Battery self-test aborted, conditions not met	Battery maintenance test conditions not met
Battery refresh charge aborted, conditions not met	Appears when the Freshening charge command is selected and the battery freshening charge condition (such as charger failure) is not met, wait the charger to start
Output must be Off	Appears when you want to change key system parameters, and the UPS output is supplying power. Shut down output power before changing these parameters.
On manual bypass, can't turn Off the load	Appears when UPS operates on manual bypass and the ON/OFF button is pressed
Please check Output Voltage, frequency and bypass setting	After the UPS is powered on, and you press the ON/OFF button for the first time, this prompt appears as a reminder to check the setting
Short Circuit Recovery	After the UPS output short circuit, wait 30s before turning on the UPS again
System is not ready	When the power modules in the frame are initializing or there are no power modules installed/active, this prompt appears when you press the ON/OFF button.
Utility not match condition, cannot turn On UPS	When the input voltage cannot meet the startup condition of the inverter, this prompt appears when you press the ON/OFF button.
Please check air filter	When the air filter reminder is 'Enabled,' this prompt appears to remind users to check the air filters and clean them if necessary.
Turn UPS Off before removing	When only one of the system monitor modules OR system control modules is installed and active, and when the locking level is moved to the unlock position, this prompt appears to remind user that a loss of output power will occur if the module is removed from the system.
Batt test unallowed	During the battery self-test process, if the battery self-test conditions are not met, the self-test stops.
Batt test passed	Battery self-test finishes and succeeds.
Batt test failed	Battery self-test finishes and fails.

## 5.0 TROUBLESHOOTING

This chapter provides the basic troubleshooting guide and required actions for maintaining the Liebert APS system.

### 5.1 Active Alarms

In the event of an alarm, the User Interface LCD will display the latest alarm message. A list of possible alarm messages are displayed in **Table 23**. If an alarm occurs and you are uncertain of the corrective action to take, contact your local Liebert Service representative.

**Table 23 Alarm message list**

Alarm Message	Possible Cause	Corrective Action
Power Module Warning	One or more power modules is not operating correctly.	View the corresponding module serial number in the fault logs or event logs and contact your local Liebert Service representative.
Power Module Fail	One or more power modules has a fault.	View the corresponding module serial number in the fault logs or event logs and either replace the module or contact your local Liebert Service representative.
Power Module Over Temp Warning	One or more power modules is operating at an internal high temperature.	Check the air filters located behind the bezels and clean if necessary, or check to see if the ambient temperature is too high. If these conditions do not exist, contact your local Liebert Service personnel.
Power Module Over Temp Shutdown	One or more power modules has stopped operating due to an internal over temperature.	Check the air filters located behind the bezels and clean if necessary, or check to see if the ambient temperature is too high. If these conditions do not exist, contact your local Liebert Service representative.
Power Module Fan Failure	One or more of the power module fans has failed.	Check to see if the fan is blocked. If not, contact your local Liebert Service representative.
Insufficient Capacity To Start Inverter	The load value exceeds the maximum load capacity of all operating modules.	Ensure all power modules are inserted and the locking lever is fully inserted. If all modules are active, add power modules to increase capacity or contact your local Liebert Service representative.
PM Locking Lever In Remove Position	The power module locking lever is not in the locked position.	Check the locking lever to ensure it is fully inserted. If so, contact your local Liebert Service representative.
Input Phase A Not Qualified	A-phase voltage is too high or too low.	Check the upstream feeder breaker or the UPS input breaker and reset if necessary, or contact your local Liebert Service representative.
Input Phase B Not Qualified	B-phase voltage is too high or too low.	Check the upstream feeder breaker or the UPS input breaker and reset if necessary, or contact your local Liebert Service representative.
Input Phase C Not Qualified	C-phase voltage is too high or too low.	Check the upstream feeder breaker or the UPS input breaker and reset if necessary or contact your local Liebert Service representative.
L1L2 Phase Reversed	Two phases are reversely connected.	Have a qualified electrician check the phase rotation at the distribution panel and/or at the UPS input terminal block. If this is not the problem, contact your local Liebert Service representative.

**Table 23 Alarm message list (continued)**

<b>Alarm Message</b>	<b>Possible Cause</b>	<b>Corrective Action</b>
Battery Reversed	The battery is reversely connected.	Have a qualified electrician check the wiring rotation at the external battery cabinet. If this is not the problem, contact your local Liebert Service representative.
No Battery Modules Are Ready	The battery module is not ready, and the yellow fault LED flashes.	Ensure that the battery module is fully inserted and locking levers are in the locked position. If this is not the problem, contact your local Liebert Service representative.
All PMs Are Not Ready	The power module is not ready, and the yellow fault LED flashes.	Ensure that the power module is fully inserted in the upper frame bays and locking levers are in the locked position. If this is not the problem, contact your local Liebert Service representative.
Power Module Redundancy Alarm	The UPS has no redundant power module	Add power modules or replace the faulty power module to obtain redundancy, or contact your local Liebert Service representative.
Output Exceeds Max Load Setting	The maximum load alarm is effective, the actual load is larger than the setting	Either decrease load on the UPS or readjust the user programmable alarm set point from the LCD. It might also require another power module to increase capacity. If this is not the problem, contact your local Liebert Service representative.
Turn Rocker Switch Off Before Removing	The bypass power is unqualified or the system output is disconnected. There is only one system monitor module or one system control module in the system, and the control lever is removed. The alarm reminds you to open the startup switch before pulling out the control module.	Open the startup switch.
Time to Check the Fan Filters for Excessive Dirt	When the air filter reminder is 'Enabled,' this message appears to remind users to check the air filters.	Check the air filters and clean them if necessary, or contact your local Liebert Service personnel.
No Matching Module	Only one battery module is inserted into one layer of bays in the system.	Ensure that there are a pair of battery modules in the same layer of the frame, or contact your local Liebert Service representative.
Load Exceeds Battery Module Capacity	The system has determined the load exceeds the capacity of the battery.	Check to ensure that all battery modules are fully inserted and the locking lever is in the locked position. It is possible that more battery modules are required to increase battery run time. If this is not the problem, contact your local Liebert Service representative.
Battery Cabinet Not Connected	The power cable of the external battery cabinet is not connected or fully inserted.	Connect the cable or contact your local Liebert Service representative.
BM Lock Lever in Remove Position	The locking lever is not in the locked position.	Check the locking lever to ensure it is fully inserted. If so, contact your local Liebert Service representative.
BM Over Temperature Warning	The internal battery module temperature is at an elevated level.	Check the air filters located behind the bezels and clean if necessary, or check to see if the ambient temperature is too high. If this is not the problem, contact your local Liebert Service representative.

**Table 23 Alarm message list (continued)**

Alarm Message	Possible Cause	Corrective Action
Low Battery Warning	The battery capacity has reached the user programmable set point.	Check upstream feeder breaker or the UPS input breaker and reset if necessary. If this is not the problem, begin the orderly shutdown of all connected equipment as UPS shutdown is imminent.
Battery Module Warning	One or more battery modules is abnormal.	View the corresponding module serial number in the fault logs or event logs and contact your local Liebert Service representative.
Battery Module Fail	One or more battery modules has a fault.	View the corresponding module serial number in the fault logs or event logs and either replace the module or contact your local Liebert Service representative.
Battery Test Warning Weak Battery	One or more battery modules has detected batteries that are no longer in specification due to age or operating conditions.	Replace the battery string or contact your local Liebert Service representative.
BM Temp Unbalance	The temperature difference between all the battery modules exceeds 10°C.	Check the air filters located behind the bezels and clean if necessary, or check to see if the ambient temperature is too high. If this is not the problem, contact your local Liebert representative.
Frame Fan Failure	The fan located behind the display panel has failed.	Contact your local Liebert Service representative for fan replacement.
Transformer Fan Failure	There is a transformer on the UPS frame and at least one transformer fan has failed.	Contact your local Liebert Service representative for fan replacement.
Transformer Temperature Warning	A high temperature condition has occurred in the output transformer area.	Check the air filters located behind the bezels and clean if necessary, or check to see if the ambient temperature is too high. If this is not the problem, contact your local Liebert Service representative.
Bypass Source Not Qualified	The UPS bypass functionality is not available because the input source is out of tolerance to the bypass voltage and/or frequency window.	No action necessary unless the AC input has been verified within bypass settings. If this is not the problem, contact your local Liebert Service representative.
Output Is Off Abnormal Output Volt	The cable connection is wrong.	Check the power distribution.
System Control Module Lock Lever in Remove Position	The locking lever is not in the locked position.	Check the locking lever to ensure it is fully inserted. If so, contact your local Liebert Service representative.
System Monitor Module Lock Lever in Remove Position	The locking lever is not in the locked position.	Check the locking lever to ensure it is fully inserted. If so, contact your local Liebert Service representative.
Charger Module Warning	The charger module is not operating correctly.	View the corresponding module serial number in the fault logs or event logs, and contact your local Liebert Service representative.
Charger Module Fail	The charger module has a fault.	View the corresponding module serial number in the fault logs or event logs, and either replace the module or contact your local Liebert Service representative.
CM Power source Is Not Qualified	Check the power distribution.	Check upstream feeder breaker or the UPS input breaker and reset if necessary, or contact your local Liebert Service representative

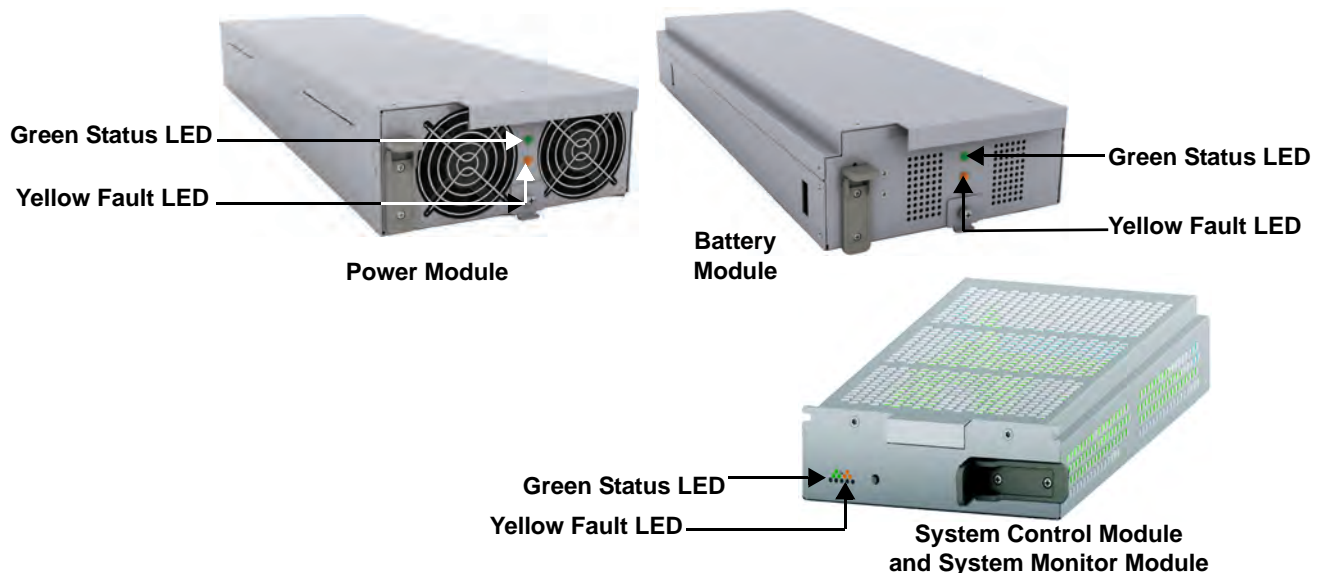
**Table 23 Alarm message list (continued)**

Alarm Message	Possible Cause	Corrective Action
Charger Module LOCK Lever in Remove Position	The locking lever is not in the locked position.	Check the locking lever to ensure it is fully inserted. If so, contact your local Liebert Service representative.
Charger Module Fan Failure	One or more of the charger module fans has failed.	Check to see if the fan is blocked. If not, contact your local Liebert Service representative.
Charger Module Temperature Warning	One or more charger modules is operating at an internal high temperature.	Check the air filters located behind the bezels and clean if necessary, or check to see if the ambient temperature is too high. If this is not the problem, contact your local Liebert Service representative.

## 5.2 Module Troubleshooting

The power, battery, charger, system control and system monitor module have two LEDs each to indicate the module operating state. **Figure 70** shows the location of these LEDs; the meaning of the LED indicators is detailed in **Table 24**.

**Figure 70 Module LED location**



**Table 24 Descriptions of module LEDs**

Green Status LED	Yellow Fault LED	Descriptions of Module State
Off	Off	The module is not inserted into the frame, lock lever is in unlocked position or the system is off
Off	On	The module is initializing (maximum 30 seconds <sup>1</sup> )
Flashing	Off	The module is operating normally
Flashing	Flashing	The module is in startup mode or the module has an alarm <sup>2</sup>
Flashing	On	The module is faulty and off-line, and the control module is operating
Off	Flashing	The module is not operating correctly, re-insert the module. If this persists, contact technical support personnel.
On	Off	
On	On	
On	Flashing	

1. If this condition persists for more than 30 seconds, verify that the lock lever is in the locked position; if it is not, the module is faulty.
2. If both green and yellow LEDs are flashing for more than 30 seconds, reinsert module.



## 5.3 Module Replacement

Follow the instructions below when replacing or adding a system control, system monitor, power, battery, or charger module. Contact your local Liebert representative if you need to purchase additional modules to expand your system or contact authorized Liebert service representative for replacement modules.

### 5.3.1 Removing Modules

1. Remove bezel cover to locate the faulty module. The yellow fault LED will be illuminated on the faulty module.



#### NOTE

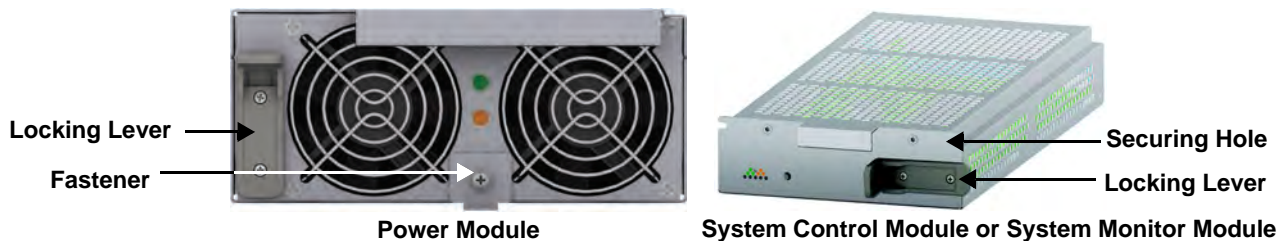
*When removing bezels from a transformer-based UPS, note which have filters and replace them accordingly. Bezels from the modules will have air filters. There will be no filters on the bottom three transformer bezels. The transformer has a separate air filter.*

*For module removal, after unlocking the lever, wait a few seconds to remove the module.*

*If your system does not contain a redundant module, you may need to manually place the UPS into manual bypass before removing modules to avoid accidental loss of output power for the connected equipment.*

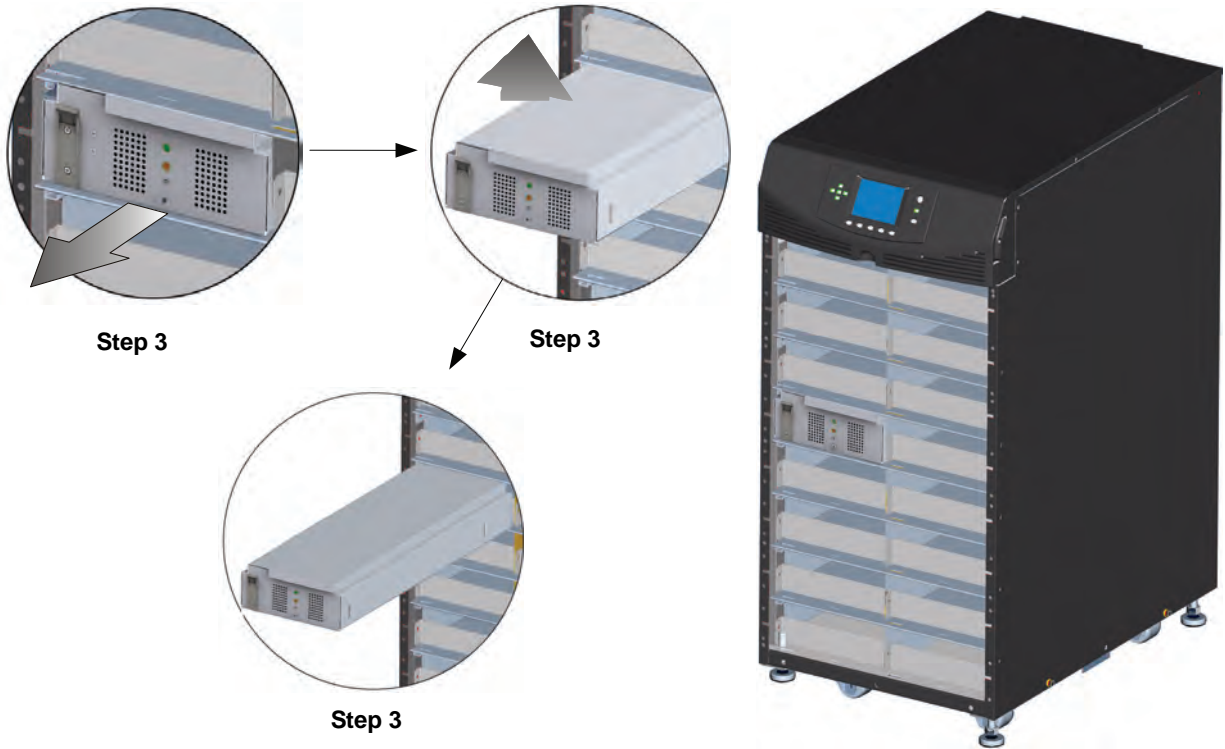
2. The method for removing a module varies depending on the module type. The two methods are as follows:
  - When removing a **power, battery or charger module**, use a Phillips screwdriver to remove the fastener (if installed). Then pull out the lock lever slightly and lift up to unlock the module.
  - When removing a **system control or system monitor module**, use a Phillips screwdriver to remove the two screws from the securing holes on each end. Then pull out the lock lever slightly and slide it to the left to unlock the module.

Figure 71 Lever and fastener



3. To pull out a power, charger or battery module:
  - a. When removing a power module, charger module or battery module: slide it 2/3 of the way out. It will be stopped by the safety catch.
  - b. Lift the module up slightly while continuing to pull it out as shown in **Figure 72**.
  - c. Support the module and slide it completely out of the unit.
  - d. When removing a system control or a system monitor module, there is no safety catch because the modules are lightweight.

Figure 72 Pull out a battery module, a power module or a charge module



## WARNING

Risk of heavy unit falling over. Can cause equipment damage, injury or death.

Read all of the instructions before attempting to move the unit, lift it, remove packaging or prepare the unit for installation.

The UPS presents a tipping hazard. Do not remove more than one module at a time. Failure to do so may cause unit to tip over and cause serious injury.

### 5.3.2 Replacing the User Interface Module

1. Remove the display bezel on top of the frame.
2. Lift up the user interface module, and put it on top of the UPS frame.
3. Disconnect the network cable from the user interface module.
4. Connect the network cable to the new user interface module.
5. Insert the new user interface module into the clips and replace the display bezel.

**Figure 73** Replacing the user interface module



## 6.0 MAINTENANCE

This chapter describes the routine maintenance for the Liebert APS UPS, including proper care, scheduled maintenance and procedures for cleaning fan filters.

### 6.1 Proper Care

Proper maintenance of the UPS is imperative to optimal performance and life of the unit. Emerson recommends that a certified technician perform preventive and corrective maintenance. Emerson Network Power Liebert Services is dedicated to ensuring the highest level of performance and unmatched support for your UPS. Contact your local Liebert representative for service.

### 6.2 Scheduled Maintenance

Emerson recommends performing the following maintenance at least monthly:

- Clean unit.
- Clean or replace filters.
- Verify proper airflow.

Emerson recommends performing the following maintenance annually:

- Verify that all power modules are operating properly.
- Verify that all battery modules are operating properly.
- Verify redundancy (if applicable).

### 6.3 Cleaning Fan Filters

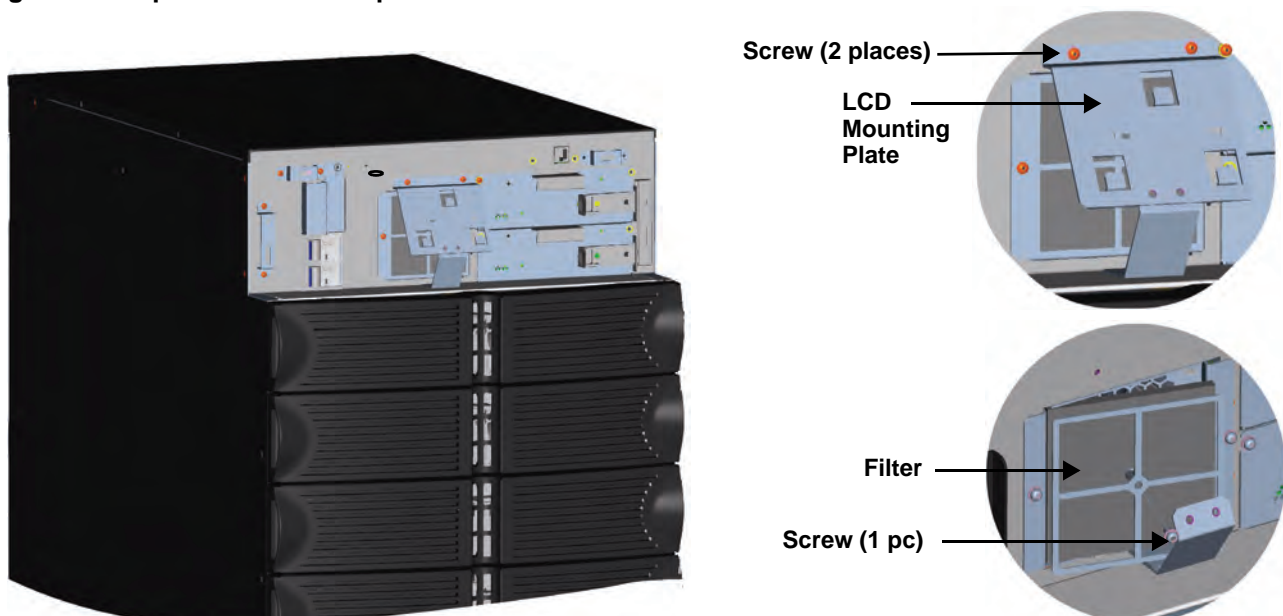
The intake fans contain filters that will need to be replaced or cleaned periodically, depending on the surrounding environment. Check filters; replace if they are very dirty or damaged.

To clean filters, either use a vacuum to remove the dirt and dust or rinse out the filters under running water (with the dirt side down) to remove dirt and dust. Blot the filters dry with a towel and allow air-drying before reinstalling it.

#### 6.3.1 Top Filter

1. Remove the display bezel.
2. Remove the user interface module, and lay it on top of the UPS frame.
3. Remove the two screws on the LCD mounting plate
4. Remove the screw in the middle of the filter assembly, remove the filter, as shown in **Figure 74**, and clean the filters as described above.
5. Replace the filter, mounting plate, user interface module and display bezel.

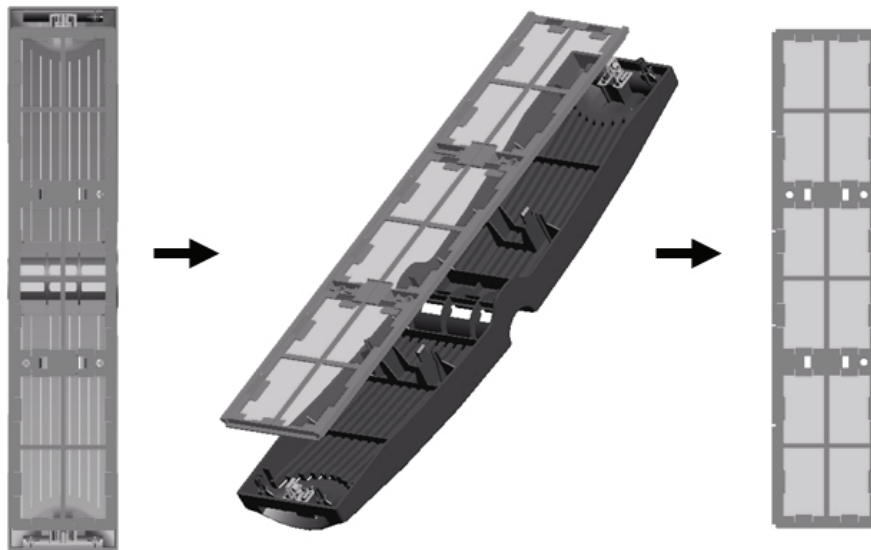
**Figure 74** Replace/clean the top filter



### 6.3.2 Bezel Filter

1. Remove the bezel from the frame.
2. Remove the filter assembly from the bezel, as shown in **Figure 75**, and clean the filters as described above.
3. Restore the filter and small plastic bezel of the frame.

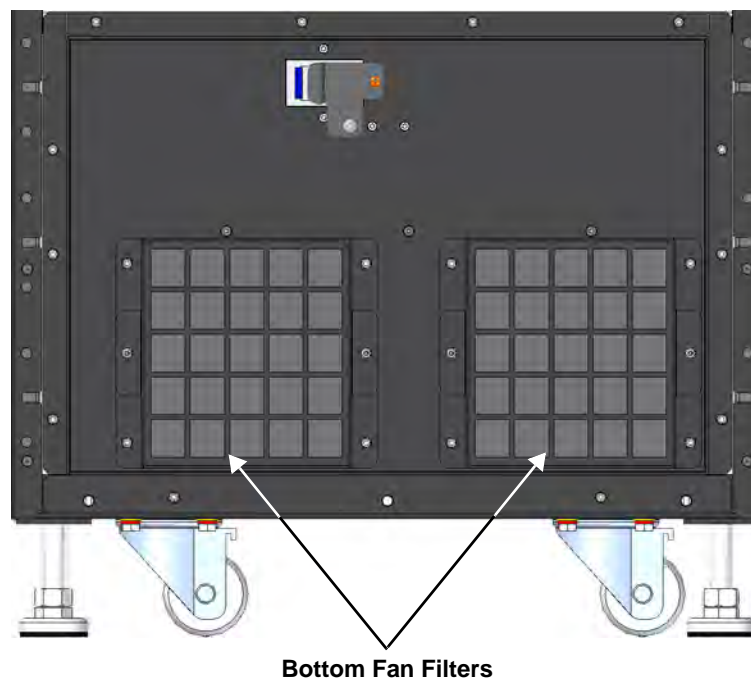
**Figure 75** Replace/clean the bezel filter



### 6.3.3 Bottom Fan Filter—Transformer-Based Frames Only

1. Remove the three lower bezels at the bottom of the frame.
2. Remove the screws and take out the filter, as shown in **Figure 76**, and clean the filters as described above.
3. Replace the filter and bezels.

**Figure 76** Replace/clean the bottom fan filter



## 7.0 SPECIFICATIONS

**Table 25 Liebert APS specifications**

Unit Size, Type	10 Bay	16 Bay	12 Bay	16 Bay	10 Bay	16 Bay
	No Transformer		Transformer-based		No Transformer Dual Inverter	
Frame Rating, kVA/kW	15/13.5	20/18	15/13.5	20/18	15/13.5	20/18
<b>General &amp; Environmental</b>						
Conducted and Radiated EMC Levels	IEC/EN/AS 62040-2 Cat 2, CISPR22 Class A, FCC Part 15 Class A					
Compliant Safety Standards	IEC/EN/AS 62040-1:2008, UL 1778 4 <sup>th</sup> Ed and CSA 22.2 No. 107.1				UL 1778 4 <sup>th</sup> Ed and CSA 22.2 No. 107.1	
Compliant Immunity Standards	IEC/EN/AS 61000-4-2, 3, 4, 5, 6					
Transportation	Individual packaged modules meet ISTA-1A / 1B; the complete system meets ISTA-1E					
UPS Classification According to IEC EN 62040-3	VFI-SS-111					
Environmental	WEEE and ROHS2 (6 by 6), REACH Compliant					
Protection Degree IEC60529	IP 20					
Color	RAL 7021					
<b>Dimensions, W x D x H, mm (in)</b>						
	440 x 800 x 695 (17x32x27)	440x850x970 (17x34x38)	440x800x1060 (17x32x42)	440x850x1240 (17x34x49)	440x800x695 (17x32x27)	440x850x970 (17x34x38)
<b>Weight, kg (lb)</b>						
Unit Weight (empty frame)	127 (280)	145.1 (320)	231.3 (510)	244.9 (540)	127 (280)	145.1 (320)
Shipping Weight (empty frame)	145.1 (320)	163.3 (360)	249.5 (550)	263.1 (580)	145.1 (320)	163.3 (360)
Unit Weight (frame rating populated)	256.3 (565)	317.5 (700)	360.6 (795)	417.3 (920)	256.3 (565)	317.5 (700)
Shipping Weight (frame rating populated)	274.4 (605)	335.7 (740)	378.7 (835)	435.4 (960)	274.4 (605)	335.7 (740)
<b>Environmental</b>						
Operating Temperature, °C (°F)	0 - 40 (32 - 104)					
Relative Humidity, %	0 - 95%, non-condensing					
Altitude, m (ft)	3000 (10000) @ 25°C (77°F)					
Efficiency (AC-AC), %	91.8-92.0	91.6-92.0	88.5-89.9	88.6-89.7	90.4-91.0	90.0-91.0
Nominal Heat Dissipation BTU/Hr (maximum)	4208	5747	5528	7965	4904	6768
Acoustic Noise Level, dBA	< 55dB (≤ 50% load), < 65dB (51-100% load) @ 1 meter					
<b>Input data</b>						
Nominal Input Voltage, VAC	200/208/220/230/240; Single-Phase				200/100, 208/120, 220/110, 230/115, 240/120; Single-Phase	
	380/400/415; Three-Phase		—	—		
Input Voltage Range, VAC	The input voltage range based on the output loading, refer to <b>Table 26</b>					
Power Factor, Cos	Single-Phase Input, ≥ 0.99; Three-phase Input, ≥ 0.95		Single-Phase Input, ≥ 0.99			
Input Frequency, Nominal, Hz	50/60					
Input Current Distortion, THDi	≤ 5%					
Input Frequency Range, Hz	40 to 70 auto-sensing					

**Table 25 Liebert APS specifications (continued)**

Unit Size, Type	10 Bay	16 Bay	12 Bay	16 Bay	10 Bay	16 Bay
	No Transformer		Transformer-based		No Transformer Dual Inverter	
Frame Rating, kVA/kW	15/13.5	20/18	15/13.5	20/18	15/13.5	20/18
<b>Battery Module</b>						
Lead-Acid Batteries Per String, Pieces	12					
Battery Cells Per String, Pieces	72					
Battery Capacity, W	36W @ 15min-rate to 1.67V per cell @25°C (77°F)					
Backup Time, Minutes, Full Load	5 (for non-redundant system which has equal number of battery strings and power modules)					
Maximum Charge Current (Full, Load)	Power module internal charger: 1.8A Charger module: 10A					
Nominal Voltage, VDC	144					
Recharge Time, Hr	< 5 to 90% capacity (PM internal charger with 1:1 ratio of PM to Battery Strings)					
<b>Output data</b>						
Output Voltage, VAC	200/208/220/230/240 Single-Phase		100/100/173/200 110/110/190/220 115/115/199/230 120/120/208/240 Single-Phase		200/100, 208/120, 220/110 230/115, 240/120 Single-Phase	
Voltage Regulation, %	±3					
Voltage Stability (100% Step Load), %	±7					
Voltage Recovery Time, ms	≤ 60					
Voltage Distortion, %	≤ 3, linear load					
	≤ 5, non-linear load		≤ 7, non-linear load		≤ 5, non-linear load	
Output Frequency, Hz	50/60					
Output Overload Capability, %	< 104% continuous					
	105% - 130% for 1 min					
	131% - 150% for 10 sec					
	151% - 200% for 1 sec					
	> 201% for 250 msec					

**Table 26 Rated input voltage range (Unit: VAC)**

% UPS Load	Low Limit Value	High Limit Value
> 100% load	170 ±5	280 ±5
90 ~ 100% load	160 ±5 ~ 170 ±5	
70 ~ 90% load	140 ±5 ~ 160 ±5	
50 ~ 70% load	120 ±5 ~ 140 ±5	
< 50% load	120 ±5	

**Table 27 Specifications of Liebert APS external battery cabinet**

Parameters	AS7EBCNCC1BX000
<b>General and Environmental</b>	
Conducted and Radiated EMC Levels	IEC/EN/AS 62040-2—Class A, FCC Part 15 (Class A)
Safety Standards	IEC/EN/AS 62040-1:2008, UL 1778 4th Ed and CSA 22.2 No. 107.3
Immunity Standards	IEC/EN/AS 61000-4-2, 3, 4, 5, 6
Transportation	ISTA-1E
Dimensions, WxDxH	17x28x38 (440x712x970)
Unit Weight, lb (kg)	147.7 (67)
Shipping Weight, lb (kg)	209.4 (95)
<b>Environmental</b>	
Operating Temperature °F (°C)	32 to 104 (0 to 40)
Storage Temperature, °F (°C)	Without battery: -4 to 140 (-20 to 60) With battery: 5 to 104 (-15 to 40)
Relative Humidity, %	0 - 95%, non-condensing
Altitude, ft. (m)	10000 (3000)
<b>Battery Module *</b>	
Lead-Acid Batteries (Per String)	12
Backup Time (Full Load), Minutes	See <b>Estimated Battery Run Times, 7.1 through 7.5</b>

\* Up to four external battery cabinets can be connected to each UPS frame and each external battery cabinet can be configured with up to seven strings of batteries.



## 7.1 Estimated Battery Run Times

### 7.1.1 Tables for UPS Where Model Number Digits 1-3 are AS1 or ASA

**Table 28 10-bay, single-phase, no transformer unit Type N (& UPS model number digit 6 = N)**

UPS Rating	Load Level	# Battery Strings																																
		1	2	3	4	5	6	7	8	9	10	11	12	13	14	15	16	17	18	19	20	21	22	23	24	25	26	27	28	29	30	31	32	
5 kVA/ 4.5 kW	100%	5	16	26	39	48	63	76	93	105	120	130	139	146	152	157	162	166	186	196	204	212	220	226	304	310	315	320	324	328	332	336	339	
	90%	6	18	30	44	52	72	90	104	120	131	140	148	154	160	165	184	195	204	213	221	300	307	313	318	323	328	332	336	340	343	346	422	
	80%	8	21	36	48	66	81	102	120	132	142	150	157	163	180	193	204	214	223	303	310	316	322	327	332	336	341	344	420	423	426	429	432	
	70%	9	25	42	53	77	100	120	134	144	153	160	166	191	204	215	225	305	313	320	326	332	337	341	346	421	425	428	432	434	437	440	442	
	60%	11	28	48	71	96	113	135	147	156	164	187	202	215	226	308	317	324	331	337	342	347	423	427	431	434	437	440	443	445	448	450	452	
	50%	15	38	60	90	112	136	150	160	181	200	216	301	312	321	329	336	343	420	425	430	434	438	441	444	447	450	452	454	456	458	460	462	
	40%	19	47	78	110	138	154	165	197	216	304	316	327	336	344	422	428	433	438	442	446	449	452	455	457	460	462	464	466	467	480	480	480	
	30%	27	66	108	142	160	192	217	309	324	336	345	426	432	438	444	448	452	456	459	462	464	466	480	480	480	480	480	480	480	480	480	480	480
	20%	44	104	148	185	222	319	337	422	432	441	448	453	458	462	466	480	480	480	480	480	480	480	480	480	480	480	480	480	480	480	480	480	480
	10%	99	166	312	345	437	450	459	466	480	480	480	480	480	480	480	480	480	480	480	480	480	480	480	480	480	480	480	480	480	480	480	480	480
10 kVA/ 9 kW	100%	-	5	10	16	21	26	33	39	44	48	52	63	70	76	81	93	99	105	110	120	126	131	135	139	143	146	149	152	155	157	160	162	
	90%	-	6	12	18	23	30	38	44	48	52	64	72	78	90	97	103	109	120	126	131	136	140	144	148	151	154	157	160	162	165	167	183	
	80%	-	8	14	21	27	36	43	48	52	66	74	81	94	102	108	120	126	132	138	142	146	150	154	157	160	163	165	180	187	193	199	204	
	70%	-	9	17	25	33	42	48	53	69	77	91	100	107	120	127	134	140	145	149	153	157	160	164	166	184	191	198	204	210	215	220	225	
	60%	-	11	20	28	41	48	53	71	81	97	106	113	128	135	142	147	152	157	161	164	167	188	196	203	210	216	222	227	304	309	313	317	
	50%	-	15	26	38	48	61	75	92	103	113	129	137	145	151	156	161	165	183	193	202	210	217	224	302	308	313	318	322	327	331	334	338	
	40%	-	20	34	47	64	79	99	111	129	140	148	155	161	166	188	199	209	218	226	306	312	318	324	329	333	337	341	345	420	424	427	429	
	30%	-	27	46	67	91	109	130	143	153	161	167	194	208	220	302	311	318	325	332	337	342	347	423	427	430	434	437	440	442	445	447	449	
	20%	-	44	73	105	133	149	161	186	207	223	309	320	330	338	345	423	428	433	438	441	445	448	451	454	456	459	461	463	464	466	480	480	
	10%	-	99	144	166	213	312	331	345	428	436	444	450	455	459	463	466	480	480	480	480	480	480	480	480	480	480	480	480	480	480	480	480	480
15 kVA/ 13.5 kW	100%	-	-	5	8	12	16	19	22	26	30	35	39	43	46	48	51	53	63	68	72	76	80	83	93	97	101	105	108	111	120	124	-	
	90%	-	-	6	10	14	18	22	26	30	35	40	44	47	50	52	61	67	72	76	80	90	95	99	103	107	110	120	124	127	131	134	-	
	80%	-	-	8	12	16	21	26	30	36	41	45	48	51	60	66	72	77	81	91	97	102	106	110	120	124	128	132	136	139	142	145	-	
	70%	-	-	9	14	19	25	30	37	42	46	50	53	65	72	77	82	94	100	105	109	120	125	129	134	138	141	145	148	151	153	156	-	
	60%	-	-	11	18	23	28	37	43	48	52	64	71	78	83	97	103	109	113	125	131	135	140	144	147	151	154	157	159	162	164	166	-	
	50%	-	-	15	22	28	38	45	50	61	71	79	92	100	107	113	126	132	137	142	147	151	155	158	161	164	166	183	190	196	202	208	-	
	40%	-	-	20	28	40	47	53	69	79	94	104	111	126	133	140	145	151	155	159	163	166	184	192	199	206	213	219	224	301	306	310	-	
	30%	-	-	27	41	50	67	80	98	109	125	135	143	150	156	161	165	184	194	204	212	220	227	305	311	316	321	325	330	334	337	341	-	
	20%	-	-	44	63	81	105	125	139	149	157	164	186	200	212	223	304	313	320	326	332	337	342	347	423	426	430	433	436	439	441	444	-	
	10%	-	-	98	132	152	165	201	222	311	324	335	344	424	430	436	441	445	449	453	456	459	461	464	466	480	480	480	480	480	480	480	480	-

Run times in this table are approximate. They are based on new, fully charged standard battery modules at a temperature of 25°C (77°F) with 100% resistive UPS loading.

**Table 29 10-bay, single-phase, no transformer unit Type N (& UPS model number digit 6 = N)**

UPS Rating	Load Level	# Battery Strings																																																																																																																																																																																																																																																																																																																																																																																																																																																																																																																																																																																																																																																																																																																																																																																																																																																																																																																																																																																																																																																																																																																																																																																																																																																																										
		1	2	3	4	5	6	7	8	9	10	11	12	13	14	15	16	17	18	19	20	21	22	23	24	25	26	27	28	29	30	31	32																																																																																																																																																																																																																																																																																																																																																																																																																																																																																																																																																																																																																																																																																																																																																																																																																																																																																																																																																																																																																																																																																																																																																																																																																																											
5 kVA / 4.5 kW	100%	5	16	26	39	48	63	76	93	105	120	130	139	146	152	157	162	166	186	196	204	212	220	226	236	304	310	315	320	324	328	332	336	340	346	422																																																																																																																																																																																																																																																																																																																																																																																																																																																																																																																																																																																																																																																																																																																																																																																																																																																																																																																																																																																																																																																																																																																																																																																																																																								
	90%	6	18	30	44	52	72	90	104	120	131	140	148	154	160	165	184	195	204	213	221	300	307	313	318	323	328	332	336	341	344	420	423	426	429	432																																																																																																																																																																																																																																																																																																																																																																																																																																																																																																																																																																																																																																																																																																																																																																																																																																																																																																																																																																																																																																																																																																																																																																																																																																								
	80%	8	21	36	48	66	81	102	120	132	142	150	157	163	180	193	204	214	223	303	310	316	322	327	332	337	341	346	421	425	428	432	434	437	440	442																																																																																																																																																																																																																																																																																																																																																																																																																																																																																																																																																																																																																																																																																																																																																																																																																																																																																																																																																																																																																																																																																																																																																																																																																																								
	70%	9	25	42	53	77	100	120	134	144	153	160	166	191	204	215	225	305	313	320	326	332	337	341	346	421	425	428	432	434	437	440	442	444	447	450	452	454	456	458	460	462																																																																																																																																																																																																																																																																																																																																																																																																																																																																																																																																																																																																																																																																																																																																																																																																																																																																																																																																																																																																																																																																																																																																																																																																																																		
	60%	11	28	48	71	96	113	135	147	156	164	187	202	215	226	308	317	324	331	337	342	347	423	427	431	434	437	440	443	445	448	450	452	454	456	458	460	462	464	466	468	470	472	474	476	478	480	482	484	486	488	490	492	494	496	498	500	502	504	506	508	510	512	514	516	518	520	522	524	526	528	530	532	534	536	538	540	542	544	546	548	550	552	554	556	558	560	562	564	566	568	570	572	574	576	578	580	582	584	586	588	590	592	594	596	598	600	602	604	606	608	610	612	614	616	618	620	622	624	626	628	630	632	634	636	638	640	642	644	646	648	650	652	654	656	658	660	662	664	666	668	670	672	674	676	678	680	682	684	686	688	690	692	694	696	698	700	702	704	706	708	710	712	714	716	718	720	722	724	726	728	730	732	734	736	738	740	742	744	746	748	750	752	754	756	758	760	762	764	766	768	770	772	774	776	778	780	782	784	786	788	790	792	794	796	798	800	802	804	806	808	810	812	814	816	818	820	822	824	826	828	830	832	834	836	838	840	842	844	846	848	850	852	854	856	858	860	862	864	866	868	870	872	874	876	878	880	882	884	886	888	890	892	894	896	898	900	902	904	906	908	910	912	914	916	918	920	922	924	926	928	930	932	934	936	938	940	942	944	946	948	950	952	954	956	958	960	962	964	966	968	970	972	974	976	978	980	982	984	986	988	990	992	994	996	998	1000	1002	1004	1006	1008	1010	1012	1014	1016	1018	1020	1022	1024	1026	1028	1030	1032	1034	1036	1038	1040	1042	1044	1046	1048	1050	1052	1054	1056	1058	1060	1062	1064	1066	1068	1070	1072	1074	1076	1078	1080	1082	1084	1086	1088	1090	1092	1094	1096	1098	1100	1102	1104	1106	1108	1110	1112	1114	1116	1118	1120	1122	1124	1126	1128	1130	1132	1134	1136	1138	1140	1142	1144	1146	1148	1150	1152	1154	1156	1158	1160	1162	1164	1166	1168	1170	1172	1174	1176	1178	1180	1182	1184	1186	1188	1190	1192	1194	1196	1198	1200	1202	1204	1206	1208	1210	1212	1214	1216	1218	1220	1222	1224	1226	1228	1230	1232	1234	1236	1238	1240	1242	1244	1246	1248	1250	1252	1254	1256	1258	1260	1262	1264	1266	1268	1270	1272	1274	1276	1278	1280	1282	1284	1286	1288	1290	1292	1294	1296	1298	1300	1302	1304	1306	1308	1310	1312	1314	1316	1318	1320	1322	1324	1326	1328	1330	1332	1334	1336	1338	1340	1342	1344	1346	1348	1350	1352	1354	1356	1358	1360	1362	1364	1366	1368	1370	1372	1374	1376	1378	1380	1382	1384	1386	1388	1390	1392	1394	1396	1398	1400	1402	1404	1406	1408	1410	1412	1414	1416	1418	1420	1422	1424	1426	1428	1430	1432	1434	1436	1438	1440	1442	1444	1446	1448	1450	1452	1454	1456	1458	1460	1462	1464	1466	1468	1470	1472	1474	1476	1478	1480	1482	1484	1486	1488	1490	1492	1494	1496	1498	1500	1502	1504	1506	1508	1510	1512	1514	1516	1518	1520	1522	1524	1526	1528	1530	1532	1534	1536	1538	1540	1542	1544	1546	1548	1550	1552	1554	1556	1558	1560	1562	1564	1566	1568	1570	1572	1574	1576	1578	1580	1582	1584	1586	1588	1590	1592	1594	1596	1598	1600	1602	1604	1606	1608	1610	1612	1614	1616	1618	1620	1622	1624	1626	1628	1630	1632	1634	1636	1638	1640	1642	1644	1646	1648	1650	1652	1654	1656	1658	1660	1662	1664	1666	1668	1670	1672	1674	1676	1678	1680	1682	1684	1686	1688	1690	1692	1694	1696	1698	1700	1702	1704	1706	1708	1710	1712	1714	1716	1718	1720	1722	1724	1726	1728	1730	1732	1734	1736	1738	1740	1742	1744	1746	1748	1750	1752	1754	1756	1758	1760	1762	1764	1766	1768	1770	1772	1774	1776	1778	1780	1782	1784	1786	1788	1790	1792	1794	1796	1798	1800	1802	1804	1806	1808	1810	1812	1814	1816	1818	1820	1822	1824	1826	1828	1830	1832	1834	1836	1838	1840	1842	1844	1846	1848	1850	1852	1854	1856	1858	1860	1862	1864	1866	1868	1870	1872	1874	1876	1878	1880	1882	1884	1886	1888	1890	1892	1894	1896	1898	1900	1902	1904	1906	1908	1910	1912	1914	1916	1918	1920	1922	1924	1926	1928	1930	1932	1934	1936	1938	1940	1942	1944	1946	1948	1950	1952	1954	1956	1958	1960	1962	1964	1966	1968	1970	1972	1974	1976	1978	1980	1982	1984	1986	1988	1990	1992	1994	1996	1998	2000	2002	2004	2006	2008	2010	2012	2014	2016	2018	2020	2022	2024	2026	2028	2030	2032	2034	2036	2038	2040	2042	2044	2046	2048	2050	2052	2054	2056	2058	2060	2062	2064	2066	2068	2070	2072	2074	2076	2078	2080	2082	2084	2086	2088	2090	2092	2094	2096	2098	2100	2102	2104	2106	2108	2110	2112	2114	2116	2118	2120	2122	2124	2126	2128	2130	2132	2134	2136	2138	2140	2142	2144	2146	2148	2150	2152	2154	2156	2158	2160	2162	2164	2166	2168	2170	2172	2174	2176	2178	2180	2182	2184	2186	2188	2190	2192	2194	2196	2198	2200	2202	2204	2206	2208	2210	2212	2214	2216	2218	2220	2222	2224	2226	2228	2230	2232	2234	2236	2238	2240	2242	2244	2246	2248	2250	2252	2254	2256	2258	2260	2262	2264	2266	2268	2270	2272	2274	2276	2278	2280	2282	2284	2286	2288	2290	2292	2294	2296	2298	2300	2302	2304	2306	2308	2310	2312	2314	2316	2318	2320	2322	2324	2326	2328	2330	2332	2334	2336	2338	2340	2342	2344	2346	2348	2350	2352	2354	2356	2358	2360	2362	2364	2366	2368	2370	2372	2374	2376	2378	2380	2382	2384	2386	2388	2390	2392	2394	2396	2398	2400	2402	2404	2406	2408	2410	2412	2414	2416	2418	2420	2422	2424	2426	2428	2430	2432	2434	2436	2438	2440	2442	2444	2446	2448	2450	2452	2454	2456	2458	2460	2462	2464	2466	2468	2470	2472	2474	2476	2478	2480	2482	2484	2486	2488	2490	2492	2494	2496	2498	2500	2502	2504	2506	2508	2510	2512	2514	2516	2518	2520	2522	2524	2526	2528	2530	2532	2534	2536	2538	2540	2542	2544	2546	2548	2550	2552	2554	2556	2558	2560	2562	2564	2566	2568	2570	2572	2574	2576	2578	2580	2582	2584	2586	2588	2590	2592	2594	2596	2598	2600	2602	2604	2606	2608	2610	2612	2614	2616	2618	2620	2622	2624	2626	2628	2630	2632	2634	2636	2638	2640	2642	2644	2646	2648	2650	2652	2654	2656	2658	2660	2662	2664	2666	2668	2670	2672	2674	2676	2678	2680	2682	2684	2686	2688	2690	2692	2694	2696	2698	2700	2702	2704	2706	2708	2710	2712	2714	2716	2718	2720	2722	2724	2726	2728	2730	2732	2734	2736	2738	2740	2742	2744	2746	2748	2750	2752	2754	2756	2758	2760	2762	2764	2766	2768	2770	2772	2774	2776	2778	2780	2782	2784	2786	2788	2790	2792	2794	2796	2798	2800	2802	2804	2806	2808	2810	2812	2814	2816	2818	2820	2822	2824	2826	2828	2830	2832	2834	2836	2838	2840	2842

**Table 30 10-bay, single-phase, no transformer unit Type R (& UPS model number digit 6 = R)**

UPS Rating	Load Level	# Battery Strings																																	
		1	2	3	4	5	6	7	8	9	10	11	12	13	14	15	16	17	18	19	20	21	22	23	24	25	26	27	28	29	30	31	32		
5 kVA/ 4.5 kW	100%	5	15	26	38	48	61	75	92	103	113	129	137	145	151	156	161	165	183	193	202	210	217	224	302	308	313	318	322	327	330	334	338		
	90%	6	17	28	43	51	70	82	101	112	129	138	146	153	158	163	167	190	200	209	218	225	304	310	315	320	325	329	334	337	341	344	347		
	80%	7	20	34	47	64	79	99	111	129	140	148	155	161	166	188	199	209	218	226	306	312	318	324	329	333	337	341	345	420	424	427	429		
	70%	9	23	40	52	74	96	110	130	141	150	158	164	184	197	209	219	300	308	315	322	327	333	338	342	346	422	425	428	431	434	437	439		
	60%	11	27	46	67	91	109	131	143	153	161	167	195	208	220	302	311	319	326	332	337	343	347	423	427	431	434	437	440	442	445	447	449		
	50%	14	35	52	80	107	131	145	156	165	191	207	221	304	314	323	331	337	343	420	425	429	433	437	440	443	446	449	451	453	455	457	459		
	40%	18	44	72	104	132	148	160	184	205	222	307	319	328	337	344	422	427	432	437	441	444	447	450	453	456	458	460	462	464	466	467	480		
	30%	25	53	99	133	153	166	203	224	312	326	336	345	425	431	437	442	446	450	453	457	459	462	464	466	480	480	480	480	480	480	480	480	480	
	20%	39	92	138	161	203	303	323	338	422	431	439	445	451	455	459	463	466	480	480	480	480	480	480	480	480	480	480	480	480	480	480	480	480	480
	10%	78	154	216	327	422	438	449	457	464	480	480	480	480	480	480	480	480	480	480	480	480	480	480	480	480	480	480	480	480	480	480	480	480	480
10 kVA /9 kW	100%	-	5	10	15	20	26	32	39	44	48	52	62	69	75	81	92	99	104	109	113	125	130	134	138	142	145	149	151	154	157	159	-		
	90%	-	6	11	18	23	28	37	43	48	52	64	71	78	83	96	103	108	113	125	130	135	140	144	147	151	154	157	159	162	164	166	-		
	80%	-	7	14	20	27	35	43	48	52	65	74	80	94	101	107	113	126	131	137	141	146	150	153	156	159	162	165	167	185	191	197	-		
	70%	-	9	16	25	33	41	48	52	67	76	83	98	106	113	126	132	138	143	148	152	156	159	163	165	181	189	195	202	207	213	218	-		
	60%	-	11	20	28	40	47	53	70	79	95	104	112	126	133	140	146	151	155	159	163	166	184	192	200	207	213	219	224	301	306	311	-		
	50%	-	14	25	37	47	53	72	83	100	110	126	134	142	148	154	159	163	167	188	197	205	213	220	226	304	309	314	319	323	327	331	-		
	40%	-	19	32	46	60	76	95	108	125	136	144	152	158	163	180	192	202	212	220	300	307	313	318	324	328	333	337	341	344	420	423	-		
	30%	-	26	44	62	81	104	124	138	148	157	163	184	199	211	222	303	311	319	325	331	336	341	346	422	426	429	432	435	438	441	443	-		
	20%	-	41	67	98	126	143	156	165	195	213	227	311	321	330	338	344	422	427	432	436	440	443	446	449	452	454	457	459	461	463	464	-		
	10%	-	90	136	160	199	300	320	336	420	429	437	444	449	454	458	462	465	480	480	480	480	480	480	480	480	480	480	480	480	480	480	480	480	
15 kVA/ 13.5 kW	100%	-	-	5	8	12	16	19	22	26	30	35	39	42	46	48	51	53	62	67	72	76	79	83	93	97	101	104	108	111	120	123	-		
	90%	-	-	6	10	13	18	21	26	28	35	39	43	46	49	52	60	66	71	75	79	83	94	98	102	106	110	113	123	127	130	133	-		
	80%	-	-	7	11	16	20	25	28	35	40	44	48	51	53	65	71	76	80	90	96	101	105	109	113	123	127	131	135	138	141	144	-		
	70%	-	-	9	14	19	25	28	36	41	46	49	52	64	71	76	81	93	98	104	108	113	123	128	132	136	140	143	147	149	152	155	-		
	60%	-	-	11	18	23	28	37	43	48	51	62	70	77	82	95	102	107	112	124	129	134	138	142	146	150	153	156	158	161	163	165	-		
	50%	-	-	15	22	28	38	44	50	60	69	77	90	98	105	111	124	130	136	141	145	149	153	156	160	162	165	180	187	193	199	205	-		
	40%	-	-	19	27	38	46	52	67	77	92	101	109	123	131	137	143	148	153	157	161	164	167	187	195	202	209	215	220	226	302	307	-		
	30%	-	-	27	40	49	64	77	94	106	122	132	140	147	153	158	163	167	188	198	207	215	222	300	306	312	317	321	326	330	334	337	-		
	20%	-	-	42	53	78	100	120	134	145	154	161	167	192	192	205	216	226	306	314	321	327	332	337	342	346	422	426	429	432	435	438	440	-	
	10%	-	-	91	125	146	161	189	212	302	316	327	337	345	424	430	436	440	445	448	452	455	457	460	462	464	466	480	480	480	480	480	480	480	-

Run times in this table are approximate. They are based on new, fully charged standard battery modules at a temperature of 25°C (77°F) with 100% resistive UPS loading.

**Table 31 10-bay, single-phase, no transformer unit Type B (& UPS model number digit 6 = B)**

UPS Rating	Load Level	# Battery Strings																																		
		1	2	3	4	5	6	7	8	9	10	11	12	13	14	15	16	17	18	19	20	21	22	23	24	25	26	27	28	29	30	31	32			
5 kVA /4.5 kW	100%	-	5	16	26	39	48	63	76	93	105	120	130	139	146	152	157	162	166	186	196	204	212	220	226	230	244	254	266	276	284	292	300	308	316	
	90%	-	6	18	30	44	52	72	90	104	120	131	140	148	154	160	165	184	195	204	213	221	300	307	313	318	323	328	332	336	340	343	346	346	346	
	80%	-	8	21	36	48	66	81	102	120	132	142	150	157	163	180	193	204	214	223	303	310	316	322	327	332	336	341	344	344	420	423	426	429	429	
	70%	-	9	25	42	53	77	100	120	134	144	153	160	166	191	204	215	225	305	313	320	326	332	337	341	346	421	425	428	432	434	437	440	440	440	
	60%	-	11	28	48	71	96	113	135	147	156	164	187	202	215	226	308	317	324	331	337	342	347	423	427	431	434	437	440	443	445	448	448	448	448	
	50%	-	15	38	60	90	112	136	150	160	181	200	216	301	312	321	329	336	343	420	425	430	434	438	441	444	447	450	452	454	456	458	460	460	460	
	40%	-	19	47	78	110	138	154	165	197	216	304	316	327	336	344	422	428	433	438	442	446	449	452	455	457	460	462	464	466	467	480	480	480	480	
	30%	-	27	66	108	142	160	192	217	309	324	336	345	426	432	438	444	448	452	456	459	462	464	466	480	480	480	480	480	480	480	480	480	480	480	480
	20%	-	44	104	148	185	222	319	337	422	432	441	448	453	458	462	466	480	480	480	480	480	480	480	480	480	480	480	480	480	480	480	480	480	480	480
	10%	-	99	166	312	345	437	450	459	466	480	480	480	480	480	480	480	480	480	480	480	480	480	480	480	480	480	480	480	480	480	480	480	480	480	480
100%	-	-	5	10	16	21	26	33	39	44	48	52	63	70	76	81	93	99	105	110	120	126	131	135	139	143	146	149	152	155	157	160	160	160		
90%	-	-	6	12	18	23	30	38	44	48	52	64	72	78	90	97	103	109	120	126	131	136	140	144	148	151	154	157	160	162	165	167	167	167		
80%	-	-	8	14	21	27	36	43	48	52	66	74	81	94	102	108	120	126	132	138	142	146	150	154	157	160	163	165	180	187	193	199	199	199		
70%	-	-	9	17	25	33	42	48	53	69	77	91	100	107	120	127	134	140	145	149	153	157	160	164	166	184	191	198	204	210	215	220	220	220		
60%	-	-	11	20	28	41	48	53	71	81	97	106	113	128	135	142	147	152	157	161	164	167	188	196	203	210	216	222	227	304	309	313	313	313		
50%	-	-	15	26	38	48	61	75	92	103	113	129	137	145	151	156	161	165	183	193	202	210	217	224	302	308	313	318	322	327	331	334	334	334		
40%	-	-	20	34	47	64	79	99	111	129	140	148	155	161	166	188	199	209	218	226	306	312	318	324	329	333	337	341	345	420	424	427	427	427		
30%	-	-	27	46	67	91	109	130	143	153	161	167	194	208	220	302	311	318	325	332	337	342	347	423	427	430	434	437	440	442	445	447	447	447		
20%	-	-	44	73	105	133	149	161	186	207	223	309	320	330	338	345	423	428	433	438	441	445	448	451	454	456	459	461	463	464	466	480	480	480		
10%	-	-	99	144	166	213	312	331	345	428	436	444	450	455	459	463	466	480	480	480	480	480	480	480	480	480	480	480	480	480	480	480	480	480	480	

Run times in this table are approximate. They are based on new, fully charged standard battery modules at a temperature of 25°C (77°F) with 100% resistive UPS loading.

**Table 32 10-bay, single-phase, no transformer unit Type F (& UPS model number digit 6 = F)**

UPS Rating	Load Level	# Battery Strings																																
		1	2	3	4	5	6	7	8	9	10	11	12	13	14	15	16	17	18	19	20	21	22	23	24	25	26	27	28	29	30	31	32	
5 kVA / 4.5 kW	100%	-	5	15	26	38	48	61	75	92	103	113	129	137	145	151	156	161	165	183	193	202	210	217	224	302	308	313	318	322	327	330	334	
	90%	-	6	17	28	43	51	70	82	101	112	129	138	146	153	158	163	167	190	200	209	218	225	304	310	320	325	329	334	337	341	344		
	80%	-	7	20	34	47	64	79	99	111	129	140	148	155	161	166	188	199	209	218	226	306	312	318	324	329	333	337	341	345	420	424	427	
	70%	-	9	23	40	52	74	96	110	130	141	150	158	164	184	197	209	219	300	308	315	322	327	333	338	342	346	422	425	428	431	434	437	
	60%	-	11	27	46	67	91	109	131	143	153	161	167	195	208	220	302	311	319	326	332	337	343	347	423	427	431	434	437	440	442	445	447	
	50%	-	14	35	52	80	107	131	145	156	165	191	207	221	304	314	323	331	337	343	420	425	429	433	437	440	443	446	449	451	453	455	457	
	40%	-	18	44	72	104	132	148	160	184	205	222	307	319	328	337	344	422	427	432	437	441	444	447	450	453	456	458	460	462	464	466	467	
	30%	-	25	53	99	133	153	166	203	224	312	326	336	345	425	431	437	442	446	450	453	457	459	462	464	466	480	480	480	480	480	480	480	
	20%	-	39	92	138	161	203	303	323	338	422	431	439	445	451	455	459	463	466	480	480	480	480	480	480	480	480	480	480	480	480	480	480	480
	10%	-	78	154	216	327	422	438	449	457	464	480	480	480	480	480	480	480	480	480	480	480	480	480	480	480	480	480	480	480	480	480	480	480
10 kVA / 9 kW	100%	-	-	5	10	15	20	26	32	39	44	48	52	62	69	75	81	92	99	104	109	113	125	130	134	138	142	145	149	151	154	157	-	
	90%	-	-	6	11	18	23	28	37	43	48	52	64	71	78	83	96	103	108	113	125	130	135	140	144	147	151	154	157	159	162	164	-	
	80%	-	-	7	14	20	27	35	43	48	52	65	74	80	94	101	107	113	126	131	137	141	146	150	153	156	159	162	165	167	185	191	-	
	70%	-	-	9	16	25	33	41	48	52	67	76	83	98	106	113	126	132	138	143	148	152	156	159	163	165	181	189	195	202	207	213	-	
	60%	-	-	11	20	28	40	47	53	70	79	95	104	112	126	133	140	146	151	155	159	163	166	184	192	200	207	213	219	224	301	306	-	
	50%	-	-	14	25	37	47	53	72	83	100	110	126	134	142	148	154	159	163	167	188	197	205	213	220	226	304	309	314	319	323	327	-	
	40%	-	-	19	32	46	60	76	95	108	125	136	144	152	158	163	180	192	202	212	220	300	307	313	318	324	328	333	337	341	344	420	-	
	30%	-	-	26	44	62	81	104	124	138	148	157	163	184	199	211	222	303	311	319	325	331	336	341	346	422	426	429	432	435	438	441	-	
	20%	-	-	41	67	98	126	143	156	165	195	213	227	311	321	330	338	344	422	427	432	436	440	443	446	449	452	454	457	459	461	463	-	
	10%	-	-	90	136	160	199	300	320	336	420	429	437	444	449	454	458	462	465	480	480	480	480	480	480	480	480	480	480	480	480	480	480	-

Run times in this table are approximate. They are based on new, fully charged standard battery modules at a temperature of 25°C (77°F) with 100% resistive UPS loading.

## 7.2 Estimated Battery Run Times

### 7.2.1 Tables for UPS Model Number Where Digits 1-3 are AS2 or ASB

**Table 33 16-bay, single-phase, no transformer unit Type N (& UPS model number digit 6 = N)**

UPS Rating	Load Level	# Battery Strings																																		
		1	2	3	4	5	6	7	8	9	10	11	12	13	14	15	16	17	18	19	20	21	22	23	24	25	26	27	28	29	30	31	32	33	34	35
5kVA / 4.5kW	100%	5	16	26	39	48	63	76	93	105	120	130	139	146	152	157	162	166	186	196	205	213	220	226	230	234	238	320	324	328	332	336	339	342	345	420
	90%	6	18	30	44	52	72	90	103	120	131	140	148	154	160	165	183	194	204	213	221	300	307	313	318	323	328	332	336	340	343	346	421	424	427	429
	80%	8	21	36	48	66	81	102	120	132	142	150	157	163	180	193	204	214	222	302	309	316	321	327	332	336	340	344	420	423	426	429	432	434	437	439
	70%	9	25	42	53	77	99	113	133	144	153	160	166	190	203	214	224	305	312	319	325	331	336	341	345	421	425	428	431	434	437	439	442	444	446	448
	60%	11	28	48	70	95	112	134	146	156	163	186	201	215	226	307	316	323	330	336	341	346	423	427	430	434	437	440	443	445	447	450	452	454	455	457
	50%	15	38	60	90	111	136	149	160	180	199	215	300	311	320	329	336	342	420	425	429	433	437	441	444	447	449	452	454	456	458	460	462	463	465	466
	40%	19	46	77	109	137	153	164	195	215	302	315	326	335	343	421	427	432	437	441	445	448	451	454	457	459	461	463	465	467	480	480	480	480	480	
	30%	27	64	106	140	159	189	215	307	322	334	344	424	431	437	443	447	451	455	458	461	463	466	480	480	480	480	480	480	480	480	480	480	480	480	480
	20%	43	102	147	180	219	316	334	420	431	439	446	452	457	461	465	480	480	480	480	480	480	480	480	480	480	480	480	480	480	480	480	480	480	480	480
	10%	96	164	308	342	434	448	457	465	480	480	480	480	480	480	480	480	480	480	480	480	480	480	480	480	480	480	480	480	480	480	480	480	480	480	480
10kVA / 9kW	100%	5	10	16	21	26	33	39	44	49	52	63	70	76	82	94	100	105	110	121	126	131	135	139	143	146	149	152	155	158	160	162	164	166	181	
	90%	6	12	18	23	30	38	44	48	52	64	72	78	90	97	104	109	120	126	131	136	140	144	148	151	154	157	160	162	165	167	184	189	195	200	
	80%	8	14	21	27	36	43	48	52	66	74	81	95	102	108	120	127	132	138	142	147	150	154	157	160	163	165	180	187	193	199	204	209	214	219	
	70%	9	17	25	33	42	48	53	69	77	91	100	107	120	127	134	140	145	149	153	157	161	164	166	184	191	198	204	210	215	220	225	302	306	310	
	60%	12	21	30	41	48	60	72	81	97	106	120	128	136	142	148	152	157	161	164	180	188	196	204	210	217	222	300	305	309	314	318	321	325	328	
	50%	15	26	38	48	61	75	92	103	113	129	137	145	151	156	161	165	183	193	202	210	217	224	302	308	313	318	322	327	331	334	338	341	344	347	
	40%	20	34	47	64	79	99	111	129	140	148	155	161	166	188	199	209	218	226	306	312	317	324	329	333	337	341	345	420	424	427	429	432	434	437	
	30%	27	46	67	91	109	130	143	153	160	167	194	208	219	301	310	318	325	331	337	342	347	352	427	430	434	437	439	442	444	447	449	451	453	455	
	20%	44	73	105	132	149	161	186	206	223	308	320	329	337	344	423	428	433	437	441	445	448	451	454	456	458	460	462	464	466	480	480	480	480	480	
	10%	98	143	165	213	311	330	344	427	436	443	449	454	459	463	466	480	480	480	480	480	480	480	480	480	480	480	480	480	480	480	480	480	480	480	480
15kVA / 13.5 kW	100%	5	8	12	16	19	22	26	30	35	40	44	47	50	52	61	67	72	76	80	90	95	99	103	107	111	120	124	128	131	134	137	140	143	-	
	90%	6	10	14	18	22	26	30	35	40	44	47	50	52	61	67	72	76	80	90	95	99	103	107	111	120	124	128	131	134	137	140	143	-		
	80%	8	12	16	21	26	30	36	41	45	48	51	60	66	72	77	81	92	97	102	106	110	120	124	129	132	136	139	142	145	148	150	153	-		
	70%	9	14	19	25	30	37	42	46	50	53	65	72	77	82	94	100	105	110	120	125	130	134	138	141	145	148	151	153	156	158	161	163	-		
	60%	12	18	23	30	38	44	48	52	64	72	78	90	97	103	109	120	126	131	136	140	144	148	151	154	157	160	162	164	167	183	189	194	-		
	50%	15	22	28	39	45	50	62	71	79	92	100	107	113	126	132	138	143	147	151	155	158	161	164	167	184	190	197	203	208	213	218	222	-		
	40%	20	28	40	47	53	70	79	94	104	112	126	133	140	146	151	155	159	163	166	184	192	200	207	213	219	224	301	306	311	315	319	322	-		
	30%	27	41	50	67	80	98	109	125	135	143	150	156	161	165	184	195	204	212	220	227	305	311	316	321	326	330	334	337	341	344	347	422	-		
	20%	44	63	82	105	126	139	149	158	164	187	201	213	224	305	313	320	327	333	338	343	347	423	427	430	433	436	439	442	444	446	448	450	-		
	10%	99	133	152	166	202	223	312	325	336	345	424	431	436	441	446	450	453	456	459	462	464	466	480	480	480	480	480	480	480	480	480	480	480	480	
20kVA / 18kW	100%	-	-	5	8	10	13	16	18	21	23	26	28	32	36	39	42	44	46	48	50	52	53	62	66	69	73	76	78	81	83	93	96	99	-	
	90%	-	-	6	9	11	14	18	20	23	26	28	34	37	41	43	46	48	50	52	54	64	68	71	75	78	81	83	93	97	100	103	106	109	-	
	80%	-	-	8	11	14	18	21	25	27	31	36	40	43	46	48	50	52	61	66	70	74	78	81	90	94	98	102	105	108	111	120	123	126	-	
	70%	-	-	9	13	17	21	25	28	33	38	42	45	48	51	53	64	69	73	77	81	91	96	100	104	107	111	120	124	127	131	134	137	140	-	
	60%	-	-	12	16	21	26	30	36	41	45	48	51	60	66	72	77	81	92	97	102	106	110	120	124	128	132	136	139	142	145	148	150	153	-	
	50%	-	-	15	20	26	32	39	44	48	51	62	69	75	81	92	98	104	109	113	124	129	134	138	142	145	148	151	154	157	159	161	163	165	-	
	40%	-	-	20	27	35	42	47	52	64	72	79	92	100	106	112	124	130	135	140	144	148	152	155	158	161	164	166	182	189	195	200	205	210	-	
	30%	-	-	27	39	46	52	67	77	92	101	109	123	131	138	143	149	153	157	161	164	167	188	195	202	209	215	221	226	303	307	311	315	319	-	
	20%	-	-	45	53	74	92	105	122	133	142	150	156	161	166	187	198	208	217	224	303	310	315	321	326	330	334	338	342	345	421	423	426	429	-	
	10%	-	-	99	127	144	157	166	197	214	300	312	322	331	339	345	423	428	433	437	441	444	447	450	453	455	457	459	461	463	465	466	480	480	480	

Run times in this table are approximate. They are based on new, fully charged standard battery modules at a temperature of 25°C (77°F) with 100% resistive UPS loading.







**Table 36 16-bay, single-phase, no transformer unit Type F (& UPS model number digit 6 = F)**

UPS Rating	Load Level	# Battery Strings																																				
		1	2	3	4	5	6	7	8	9	10	11	12	13	14	15	16	17	18	19	20	21	22	23	24	25	26	27	28	29	30	31	32	33	34	35		
5 kVA/ 4.5 kW	100%	-	5	15	26	38	48	61	75	92	103	113	129	137	145	151	156	161	165	183	193	202	210	218	224	302	308	313	318	323	327	331	334	338	341	344		
	90%	-	6	17	28	43	51	70	82	101	112	129	138	146	152	158	163	167	190	200	209	217	225	303	309	315	320	325	329	333	337	341	344	347	422	425		
	80%	-	7	20	34	47	63	79	99	111	129	139	148	155	161	166	187	199	209	218	226	305	312	318	323	328	333	337	341	345	420	423	426	429	432	434		
	70%	-	9	23	40	52	74	96	111	130	141	150	158	164	184	198	209	219	300	308	315	322	328	333	338	342	346	422	425	429	432	434	437	439	442	444		
	60%	-	11	28	46	68	92	110	131	144	153	161	180	196	209	221	303	312	319	326	332	338	343	420	424	428	431	434	437	440	443	445	447	450	452	453		
	50%	-	14	36	52	81	108	132	146	157	165	192	208	222	308	319	329	337	344	421	426	430	434	437	441	444	444	446	449	451	454	456	458	459	461	463		
	40%	-	18	44	73	104	132	149	161	185	206	222	308	319	329	337	344	422	428	433	437	441	445	448	451	453	456	458	460	462	464	466	467	480	480	480		
	30%	-	25	53	99	133	153	166	202	223	312	325	336	345	424	431	437	441	446	450	453	456	462	464	466	480	480	480	480	480	480	480	480	480	480	480	480	
	20%	-	38	90	136	160	199	300	320	336	420	429	437	444	449	454	458	462	465	480	480	480	480	480	480	480	480	480	480	480	480	480	480	480	480	480	480	480
	10%	-	73	149	207	320	345	433	445	454	461	466	480	480	480	480	480	480	480	480	480	480	480	480	480	480	480	480	480	480	480	480	480	480	480	480	480	480
10 kVA / 9 kW	100%	-	5	10	16	21	26	32	39	44	48	52	62	69	76	81	93	99	104	109	120	125	130	134	138	142	145	149	152	154	157	159	162	164	-	-		
	90%	-	6	11	18	23	28	37	43	48	52	64	71	78	83	97	103	108	113	125	131	135	140	144	147	151	154	157	159	162	164	166	182	188	-	-		
	80%	-	7	14	20	27	36	43	48	52	66	74	81	94	101	108	113	126	132	137	142	146	150	153	157	160	162	165	167	185	192	197	203	208	-	-		
	70%	-	9	17	25	33	42	48	53	68	76	90	99	106	113	126	133	138	144	148	152	156	160	163	166	182	189	196	202	208	213	218	223	300	-	-		
	60%	-	11	20	28	40	47	53	70	79	95	104	112	126	134	142	148	154	159	163	167	187	197	205	213	219	226	304	309	314	319	323	327	331	334	338	-	
	50%	-	14	25	37	47	53	72	83	100	110	126	134	152	158	163	180	192	202	212	220	300	306	313	318	324	328	333	337	341	344	420	423	426	428	-	-	
	40%	-	19	32	46	60	76	95	108	125	136	144	152	163	184	198	211	221	303	311	318	325	331	336	341	346	422	425	429	432	435	438	440	443	445	447	-	
	30%	-	26	44	62	80	104	124	138	148	156	163	184	198	211	221	303	311	318	325	331	336	341	346	422	425	429	432	435	438	440	443	445	447	-	-		
	20%	-	41	67	98	125	143	156	165	194	212	227	311	321	330	337	344	422	427	432	436	440	443	446	449	452	454	456	459	461	462	464	466	467	-	-		
	10%	-	83	135	159	199	227	320	335	347	429	437	443	449	454	458	461	465	467	480	480	480	480	480	480	480	480	480	480	480	480	480	480	480	480	480	480	-
15 kVA / 13.5 kW	100%	-	5	8	12	16	19	22	26	30	35	39	43	46	48	51	53	63	67	72	76	79	83	93	97	101	105	108	111	120	124	127	130	-	-			
	90%	-	6	10	14	18	21	26	28	35	40	45	48	51	53	65	71	76	80	91	96	101	105	109	113	123	127	130	134	137	140	-	-	-	-			
	80%	-	7	11	16	20	25	28	36	42	46	50	53	64	71	77	81	93	99	104	109	113	124	129	133	137	140	144	147	150	153	155	157	160	-	-		
	70%	-	9	14	19	25	32	37	45	50	56	63	70	77	83	95	102	107	112	124	129	134	139	143	146	150	153	156	159	161	163	166	180	186	-	-		
	60%	-	11	18	23	28	38	45	50	60	69	77	90	98	105	111	124	130	136	141	145	150	153	157	160	163	165	180	187	193	199	205	210	215	-	-		
	50%	-	15	22	28	38	45	50	60	70	80	92	101	109	123	131	138	143	149	153	157	161	164	167	188	195	203	209	215	221	226	303	307	311	315	-		
	40%	-	19	27	39	46	52	67	77	95	106	122	132	140	147	153	158	163	167	189	198	207	215	222	300	306	312	317	322	326	330	334	337	341	344	-	-	
	30%	-	27	40	49	64	77	95	106	122	132	140	147	153	158	163	167	189	198	207	215	222	300	306	312	317	322	326	330	334	337	341	344	-	-			
	20%	-	42	53	78	101	121	135	145	154	161	167	193	205	216	226	307	314	321	327	333	338	342	347	422	426	429	432	435	438	440	443	445	-	-			
	10%	-	92	126	147	161	190	213	302	316	328	338	346	425	431	436	441	445	449	452	455	458	460	463	465	467	480	480	480	480	480	480	480	480	480	480	480	-
20 kVA / 18 kW	100%	-	5	8	10	13	16	18	21	23	26	28	32	36	39	42	44	46	48	50	52	53	63	67	71	75	78	81	83	93	96	100	103	-	-			
	90%	-	6	9	11	14	18	20	23	26	28	31	35	39	43	45	48	50	52	61	65	70	74	77	80	83	93	97	101	104	107	110	113	-	-			
	80%	-	7	10	14	17	20	23	27	31	35	38	42	45	48	50	53	62	68	72	76	80	90	94	99	103	106	110	113	122	126	129	133	-	-			
	70%	-	9	13	17	20	25	28	33	38	42	44	48	51	53	65	70	75	80	90	95	100	104	109	112	122	127	130	134	137	141	143	146	-	-			
	60%	-	11	16	20	25	28	35	40	44	48	51	53	65	70	75	80	90	96	102	107	111	122	127	131	136	139	143	146	149	152	155	157	160	-	-		
	50%	-	15	20	26	31	38	43	47	51	60	67	73	79	90	96	102	107	111	122	133	138	142	146	150	153	156	159	162	164	167	184	190	195	-	-		
	40%	-	19	26	33	41	46	51	62	70	77	83	97	104	109	121	127	133	138	142	146	150	153	156	159	162	164	167	184	190	195	-	-					
	30%	-	27	37	45	51	65	75	83	98	107	120	128	134	141	146	151	155	159	162	165	182	190	197	204	210	216	221	226	303	307	-	-					
	20%	-	43	52	71	83	102	113	130	139	147	153	159	164	180	192	202	211	219	226	305	311	316	321	326	330	334	342	345	420	-	-						
	10%	-	95	122	140	153	163	189	207	222	307	317	326	334	341	347	424	429	433	437	441	444	447	450	452	455	457	459	461	463	464	-	-					

Run times in this table are approximate. They are based on new, fully charged standard battery modules at a temperature of 25°C (77°F) with 100% resistive UPS loading.

### 7.3 Estimated Battery Run Times

#### 7.3.1 Tables for UPS model number digits 1-3 are AS3 or ASC

**Table 37 12-bay, single-phase, transformer-based unit Type N (& UPS model number 6 = N)**

UPS Rating	Load Level	# Battery Strings																																	
		1	2	3	4	5	6	7	8	9	10	11	12	13	14	15	16	17	18	19	20	21	22	23	24	25	26	27	28	29	30	31	32	33	
5 kVA/ 4.5 kW	100%	5	15	26	38	47	60	74	90	102	112	127	136	143	150	155	160	164	181	191	200	208	215	222	300	306	311	316	321	325	329	333	336	343	
	90%	6	17	28	42	51	69	82	101	111	128	137	145	152	158	163	167	189	199	208	216	224	302	309	314	319	324	329	333	337	340	343	347	421	
	80%	7	20	34	47	63	79	99	111	129	139	148	155	160	166	187	198	209	218	226	305	312	318	323	328	333	337	341	345	420	423	426	429	432	
	70%	9	23	40	52	74	96	110	130	141	150	157	164	184	197	209	219	300	308	315	321	327	332	337	342	346	422	425	428	431	434	437	439	441	
	60%	11	27	46	67	92	109	131	143	153	161	167	195	209	220	302	311	319	326	332	338	343	347	423	427	431	434	437	440	442	445	447	449	451	
	50%	14	36	52	81	108	132	146	157	165	192	208	222	305	315	324	331	338	344	421	426	430	434	437	441	444	446	449	451	453	456	457	459	461	
	40%	18	44	73	105	133	149	161	186	207	223	309	320	330	338	345	423	428	433	438	441	445	448	451	454	456	459	461	463	464	466	480	480	480	
	30%	25	53	101	135	154	167	206	227	315	328	338	347	427	433	438	443	448	451	455	458	460	463	465	467	480	480	480	480	480	480	480	480	480	480
	20%	40	96	141	164	208	308	327	342	425	434	441	448	453	457	461	465	480	480	480	480	480	480	480	480	480	480	480	480	480	480	480	480	480	480
	10%	82	158	225	333	427	442	453	460	467	480	480	480	480	480	480	480	480	480	480	480	480	480	480	480	480	480	480	480	480	480	480	480	480	480
10 kVA/ 9 kW	100%	-	5	10	15	20	26	31	38	43	48	51	61	68	74	80	91	97	103	108	112	123	128	133	137	140	144	147	150	153	158	160	163		
	90%	-	6	11	17	23	28	37	43	47	51	62	70	76	82	95	101	107	112	123	129	134	138	142	146	149	152	155	158	161	163	165	167	185	
	80%	-	7	13	20	27	35	42	47	52	64	72	79	92	99	106	112	124	130	135	140	144	148	152	155	158	161	164	166	182	189	194	200	205	
	70%	-	9	16	23	32	41	47	52	66	75	83	97	105	112	125	131	137	142	147	151	155	159	162	165	167	187	193	200	206	211	216	221	226	
	60%	-	11	20	28	39	47	53	69	79	94	103	111	125	133	139	145	150	155	159	162	166	183	191	199	206	212	218	224	301	305	310	314	318	
	50%	-	14	25	37	47	53	72	83	100	110	126	134	142	148	154	159	163	167	188	197	205	213	220	226	304	309	314	319	323	327	331	334	338	
	40%	-	19	33	46	60	76	95	108	126	136	145	152	158	163	181	193	203	213	221	300	307	313	319	324	329	333	338	341	345	420	423	426	429	
	30%	-	26	44	62	81	104	125	138	149	157	164	185	200	212	223	304	312	319	326	332	337	342	346	422	426	430	433	436	438	441	443	446	448	
	20%	-	41	67	98	126	143	156	165	195	213	227	311	322	330	338	344	422	427	432	436	440	443	447	449	452	455	457	459	461	463	464	466	467	
	10%	-	83	135	159	197	226	319	335	347	428	436	443	448	453	457	461	464	467	480	480	480	480	480	480	480	480	480	480	480	480	480	480	480	480
15 kVA/ 13.5 kW	100%	-	-	5	8	11	15	18	22	26	28	34	38	42	45	47	50	52	60	65	70	74	78	81	91	95	99	102	106	109	112	121	125	-	
	90%	-	-	6	9	13	17	21	25	28	34	39	43	46	49	51	53	65	70	74	78	82	92	97	101	105	108	112	121	125	129	132	135	-	
	80%	-	-	7	11	16	20	25	28	35	40	44	47	50	53	64	70	75	79	83	95	99	104	108	112	122	126	130	133	137	140	143	146	-	
	70%	-	-	9	14	18	23	28	35	41	45	49	52	63	69	75	80	91	97	102	107	111	122	127	131	135	139	142	145	148	151	154	156	-	
	60%	-	-	11	17	23	28	36	42	47	51	61	69	76	81	94	100	106	111	122	128	133	137	141	145	148	152	155	157	160	162	165	167	-	
	50%	-	-	14	21	28	37	44	49	53	68	76	83	97	104	110	122	129	134	139	144	148	152	155	159	162	164	167	184	191	197	202	208	-	
	40%	-	-	19	27	38	46	52	67	76	91	100	109	122	130	137	143	148	152	157	160	164	167	186	194	201	207	213	219	224	301	306	310	-	
	30%	-	-	27	40	49	64	77	95	106	122	132	140	147	153	158	163	167	188	198	207	215	222	300	306	312	317	321	326	330	334	337	341	-	
	20%	-	-	43	60	79	102	123	136	147	155	162	181	196	208	219	301	309	316	323	329	335	340	344	420	424	428	431	434	437	439	442	444	-	
	10%	-	-	97	131	151	164	199	220	309	322	333	343	422	429	435	440	444	448	452	455	458	460	463	465	467	480	480	480	480	480	480	480	480	-

Run times in this table are approximate. They are based on new, fully charged standard battery modules at a temperature of 25°C (77°F) with 100% resistive UPS loading.

**Table 38 12-bay, single-phase, transformer-based unit Type R (& UPS model number 6 = R)**

UPS Rating	Load Level	# Battery Strings																																		
		1	2	3	4	5	6	7	8	9	10	11	12	13	14	15	16	17	18	19	20	21	22	23	24	25	26	27	28	29	30	31	32	33		
5 kVA/ 4.5 kW	100%	5	14	25	37	47	53	72	83	100	110	126	134	142	148	154	159	163	167	187	197	205	213	219	226	304	309	314	319	323	327	331	334	338		
	90%	5	16	27	41	50	67	80	98	109	126	135	143	150	156	161	165	185	195	205	213	221	227	306	311	317	322	326	330	334	338	341	344	347		
	80%	7	19	33	46	61	76	96	108	126	137	145	152	158	164	182	193	204	213	222	301	308	314	320	325	330	334	338	342	345	421	424	426	429		
	70%	8	22	39	50	71	92	107	126	138	147	155	161	167	190	203	213	222	303	310	317	323	328	333	338	342	346	422	425	428	431	434	436	439		
	60%	10	26	44	63	81	105	126	139	149	157	164	186	200	213	223	304	313	320	326	332	338	342	347	423	426	430	433	436	439	441	444	446	448		
	50%	13	32	50	76	102	125	140	152	161	180	197	212	224	307	316	324	331	337	343	420	424	428	432	436	439	442	445	447	449	452	454	456	457		
	40%	16	41	66	97	125	142	155	165	193	211	226	310	320	329	337	343	421	426	431	435	439	443	446	449	451	454	456	458	460	462	464	465	467		
	30%	22	50	91	125	147	161	190	212	302	316	328	337	346	425	431	436	441	445	448	452	455	458	460	462	465	467	480	480	480	480	480	480	480	480	
	20%	35	79	130	155	188	219	313	329	342	424	432	439	445	450	454	458	462	465	467	480	480	480	480	480	480	480	480	480	480	480	480	480	480	480	480
	10%	71	147	203	317	342	431	443	452	459	465	480	480	480	480	480	480	480	480	480	480	480	480	480	480	480	480	480	480	480	480	480	480	480	480	480
100%	-	5	10	15	20	26	31	38	43	47	51	60	67	74	79	90	96	102	107	112	122	127	132	136	140	143	147	150	152	155	158	160	-	-		
90%	-	6	11	17	22	28	36	42	47	51	61	69	75	81	93	100	106	111	122	127	132	137	141	145	148	151	154	157	160	162	164	166	-	-		
80%	-	7	13	19	26	34	41	47	51	63	71	78	90	98	105	110	122	128	134	139	143	147	151	154	157	160	163	165	167	186	192	197	-	-		
70%	-	9	16	23	31	40	47	51	65	74	81	95	103	110	123	129	135	141	145	150	154	157	160	163	166	183	190	196	202	208	213	218	-	-		
60%	-	11	19	27	38	46	52	67	77	91	101	109	123	131	137	143	148	153	157	161	164	167	187	195	202	208	214	220	225	302	307	311	-	-		
50%	-	14	25	36	46	52	70	81	98	108	122	132	139	146	152	157	161	165	182	192	200	208	215	222	300	305	310	315	319	324	327	331	-	-		
40%	-	18	30	44	52	73	91	105	121	132	141	149	155	161	165	186	197	206	215	223	302	308	314	320	325	329	333	337	341	344	420	423	-	-		
30%	-	25	42	53	77	100	120	134	144	153	160	166	191	204	215	225	305	313	320	326	332	337	341	346	421	425	428	432	434	437	440	442	-	-		
20%	-	38	61	91	112	137	150	161	182	201	217	302	313	322	330	337	343	421	426	430	434	438	442	445	447	450	452	455	457	459	461	462	-	-		
10%	-	75	124	151	167	211	306	323	336	347	428	435	441	447	451	455	459	462	465	467	480	480	480	480	480	480	480	480	480	480	480	480	480	480	480	
100%	-	-	5	8	11	15	18	22	26	28	33	38	41	45	47	50	52	60	65	70	74	77	81	90	94	98	102	105	109	112	121	124	-	-		
90%	-	-	6	9	13	17	21	25	28	34	38	42	46	48	51	53	64	69	74	78	81	91	96	100	104	108	111	120	124	128	131	134	-	-		
80%	-	-	7	11	16	20	25	28	34	39	43	47	50	52	63	69	74	78	82	93	98	103	107	111	121	125	129	132	136	139	142	145	-	-		
70%	-	-	9	13	18	23	28	35	40	45	49	52	62	69	74	79	90	96	101	106	111	121	126	130	134	138	141	145	148	150	153	155	-	-		
60%	-	-	11	17	22	28	36	42	47	51	60	68	75	81	93	99	105	110	121	127	132	136	140	144	148	151	154	157	159	162	164	166	-	-		
50%	-	-	14	21	27	36	43	49	53	67	75	82	95	103	109	121	127	133	138	143	147	151	155	158	161	163	166	182	188	194	200	206	-	-		
40%	-	-	18	27	37	45	51	65	75	83	99	107	120	128	135	141	146	151	155	159	162	166	182	190	197	204	210	216	221	226	303	308	-	-		
30%	-	-	26	38	48	61	75	91	103	113	129	137	144	151	156	161	165	183	193	202	210	217	224	302	308	313	318	322	326	330	334	337	-	-		
20%	-	-	41	52	75	97	112	131	142	151	159	165	186	200	211	221	302	310	317	323	329	334	339	343	347	423	423	426	430	432	435	480	480	-	-	
10%	-	-	82	121	143	158	183	206	225	311	323	333	342	421	427	433	438	442	446	449	453	455	458	460	463	465	467	480	480	480	480	480	480	-	-	

Run times in this table are approximate. They are based on new, fully charged standard battery modules at a temperature of 25°C (77°F) with 100% resistive UPS loading.

**Table 39 12-bay, single-phase, transformer-based unit Type B (& UPS model number 6 = B)**

UPS Rating	Load Level	# Battery Strings																																	
		1	2	3	4	5	6	7	8	9	10	11	12	13	14	15	16	17	18	19	20	21	22	23	24	25	26	27	28	29	30	31	32	33	
5 kVA / 4.5 kW	100%	-	5	15	26	38	47	60	74	90	102	112	127	136	143	150	155	160	164	181	191	200	208	215	222	300	306	311	316	321	325	329	333	336	
	90%	-	6	17	28	42	51	69	82	101	111	128	137	145	152	158	163	167	189	199	208	216	224	302	309	314	319	324	329	333	337	340	343	347	
	80%	-	7	20	34	47	63	79	99	111	129	139	148	155	160	166	187	198	209	218	226	305	312	318	323	328	333	337	341	345	420	423	426	429	
	70%	-	9	23	40	52	74	96	110	130	141	150	157	164	184	197	209	219	300	308	315	321	327	332	337	342	346	422	425	428	431	434	437	439	
	60%	-	11	27	46	67	92	109	131	143	153	161	167	195	209	220	302	311	319	326	332	338	343	347	423	427	431	434	437	440	442	445	447	449	
	50%	-	14	36	52	81	108	132	146	157	165	192	208	222	305	315	324	331	338	344	421	426	430	434	437	441	444	446	449	451	453	456	457	459	
	40%	-	18	44	73	105	133	149	161	186	207	223	309	320	330	338	345	423	428	433	438	441	445	448	451	454	456	459	461	463	464	466	480	480	
	30%	-	25	53	101	135	154	167	206	227	315	328	338	347	427	433	438	443	448	451	455	458	460	463	465	467	480	480	480	480	480	480	480	480	
	20%	-	40	96	141	164	208	308	327	342	425	434	441	448	453	457	461	465	480	480	480	480	480	480	480	480	480	480	480	480	480	480	480	480	480
	10%	-	82	158	225	333	427	442	453	460	467	480	480	480	480	480	480	480	480	480	480	480	480	480	480	480	480	480	480	480	480	480	480	480	480
10 kVA / 9 kW	100%	-	-	5	10	15	20	26	31	38	43	48	51	61	68	74	80	91	97	103	108	112	123	128	133	137	140	144	147	150	153	156	158	160	
	90%	-	-	6	11	17	23	28	37	43	47	51	62	70	76	82	95	101	107	112	123	129	134	138	142	146	149	152	155	158	161	163	165	167	
	80%	-	-	7	13	20	27	35	42	47	52	64	72	79	92	99	106	112	124	130	135	140	144	148	152	155	158	161	164	166	182	189	194	200	
	70%	-	-	9	16	23	32	41	47	52	66	75	83	97	105	112	125	131	137	142	147	151	155	159	162	165	167	187	193	200	206	211	216	221	
	60%	-	-	11	20	28	39	47	53	69	79	94	103	111	125	133	139	145	150	155	159	162	166	183	191	199	206	212	218	224	301	305	310	314	
	50%	-	-	14	25	37	47	53	72	83	100	110	126	134	142	148	154	159	163	167	188	197	205	213	220	226	304	309	314	319	323	327	331	334	
	40%	-	-	19	33	46	60	76	95	108	126	136	145	152	158	163	181	193	203	213	221	300	307	313	319	324	329	333	338	341	345	420	423	426	
	30%	-	-	26	44	62	81	104	125	138	149	157	164	185	200	212	223	304	312	319	326	332	337	342	346	422	426	430	433	436	438	441	443	446	
	20%	-	-	41	67	98	126	143	166	165	195	213	227	311	322	330	338	344	422	427	432	436	440	443	447	449	452	455	457	459	461	463	464	466	
	10%	-	-	83	135	159	197	226	319	335	347	428	436	443	448	453	457	461	464	467	480	480	480	480	480	480	480	480	480	480	480	480	480	480	480

Run times in this table are approximate. They are based on new, fully charged standard battery modules at a temperature of 25°C (77°F) with 100% resistive UPS loading.

**Table 40 12-bay, single-phase, transformer-based unit Type F (& UPS model number 6 = F)**

UPS Rating	Load Level	# Battery Strings																																			
		1	2	3	4	5	6	7	8	9	10	11	12	13	14	15	16	17	18	19	20	21	22	23	24	25	26	27	28	29	30	31	32	33			
5 kVA/ 4.5 kW	100%	-	5	14	25	37	47	53	72	83	100	110	126	134	142	148	154	159	163	167	187	197	205	213	219	226	304	309	314	319	323	327	331	334			
	90%	-	5	16	27	41	50	67	80	98	109	126	135	143	150	156	161	165	185	195	205	213	221	227	306	311	317	322	326	330	334	338	341	344			
	80%	-	7	19	33	46	61	76	96	108	126	137	145	152	158	164	182	193	204	213	222	301	308	314	320	325	330	334	338	342	345	421	424	424	426		
	70%	-	8	22	39	50	71	92	107	126	138	147	155	161	167	190	203	213	222	303	310	317	323	328	333	338	342	346	422	425	428	431	434	434	436		
	60%	-	10	26	44	63	81	105	126	139	149	157	164	186	200	213	223	304	313	320	326	332	338	342	347	423	426	430	433	436	439	441	444	444	446		
	50%	-	13	32	50	76	102	125	140	152	161	180	197	212	224	307	316	324	331	337	343	420	424	428	432	436	439	442	445	447	449	452	454	454	456		
	40%	-	16	41	66	97	125	142	155	165	193	211	226	310	320	329	337	343	421	426	431	435	439	443	446	449	451	454	456	458	460	462	464	464	465		
	30%	-	22	50	91	125	147	161	190	212	302	316	328	337	346	425	431	436	441	445	448	452	455	458	460	462	465	467	480	480	480	480	480	480	480	480	
	20%	-	35	79	130	155	188	219	313	329	342	424	432	439	445	450	454	458	462	465	467	480	480	480	480	480	480	480	480	480	480	480	480	480	480	480	480
	10%	-	71	147	203	317	342	431	443	452	459	465	480	480	480	480	480	480	480	480	480	480	480	480	480	480	480	480	480	480	480	480	480	480	480	480	480
100%	-	-	5	10	15	20	26	31	38	43	47	51	60	67	74	79	90	96	102	107	112	122	127	132	136	140	143	147	150	152	155	158	-	-			
90%	-	-	6	11	17	22	28	36	42	47	51	61	69	75	81	93	100	106	111	122	127	132	137	141	145	148	151	154	157	160	162	164	-	-			
80%	-	-	7	13	19	26	34	41	47	51	63	71	78	90	98	105	110	122	128	134	139	143	147	151	154	157	160	163	165	167	186	192	-	-			
70%	-	-	9	16	23	31	40	47	51	65	74	81	95	103	110	123	129	135	141	145	150	154	157	160	163	166	183	190	196	202	208	213	-	-			
60%	-	-	11	19	27	38	46	52	67	77	91	101	109	123	131	137	143	148	153	157	161	164	167	187	195	202	208	214	220	225	302	307	-	-			
50%	-	-	14	25	36	46	52	70	81	98	108	122	132	139	146	152	157	161	165	182	192	200	208	215	222	300	305	310	315	319	324	327	-	-			
40%	-	-	18	30	44	52	73	91	105	121	132	141	149	155	161	165	186	197	206	215	223	302	308	314	320	325	329	333	337	341	344	420	-	-			
30%	-	-	25	42	53	77	100	120	134	144	153	160	166	191	204	215	225	305	313	320	326	332	337	341	346	421	425	428	432	434	437	440	-	-			
20%	-	-	38	61	91	112	137	150	161	182	201	217	302	313	322	330	337	343	421	426	430	434	438	442	445	447	450	452	455	457	459	461	-	-			
10%	-	-	75	124	151	167	211	306	323	336	347	428	435	441	447	451	455	459	462	465	467	480	480	480	480	480	480	480	480	480	480	480	480	480	480	480	

Run times in this table are approximate. They are based on new, fully charged standard battery modules at a temperature of 25°C (77°F) with 100% resistive UPS loading.

### 7.4 Estimated Battery Run Times

#### 7.4.1 Tables for UPS Model Number Where Digits 1-3 are AS4 or ASD

**Table 41 16-bay, single-phase, transformer-based unit Type N (& UPS model number 6 = N)**

UPS Rating	Load Level	# Battery Strings																																			
		1	2	3	4	5	6	7	8	9	10	11	12	13	14	15	16	17	18	19	20	21	22	23	24	25	26	27	28	29	30	31	32	33	34	35	
5 kVA / 4.5 kW	100%	5	15	26	38	47	60	74	90	102	111	127	136	143	149	155	160	164	180	190	199	207	215	222	300	306	311	316	320	325	329	332	336	339	342	345	
	90%	6	17	28	42	51	69	81	100	111	128	137	145	152	157	162	167	188	198	208	216	223	302	308	314	319	324	328	332	336	340	343	346	421	424	426	
	80%	7	19	34	47	63	78	98	110	128	139	147	154	160	165	186	197	208	217	225	304	311	317	322	327	332	336	340	344	347	423	426	428	431	434	436	
	70%	9	23	40	51	74	95	110	129	141	150	157	163	183	196	208	218	227	307	314	321	327	332	337	341	345	421	425	428	431	434	436	439	441	443	445	
	60%	11	27	46	67	91	109	130	143	153	160	167	194	208	219	301	310	318	325	331	337	342	347	423	427	430	434	437	439	442	444	447	449	451	453	455	
	50%	14	35	52	80	107	131	145	156	164	190	207	221	304	314	323	330	337	343	420	425	429	433	437	440	443	446	448	451	453	455	457	459	461	462	464	
	40%	18	44	73	104	132	149	160	185	206	222	308	319	329	337	344	422	428	433	437	441	444	448	451	453	456	458	460	462	464	466	467	480	480	480	480	
	30%	25	53	100	134	154	167	205	226	314	327	337	346	426	432	438	443	447	451	454	457	460	462	465	467	480	480	480	480	480	480	480	480	480	480	480	
	20%	40	94	140	163	206	306	326	340	424	433	440	447	452	457	460	464	467	480	480	480	480	480	480	480	480	480	480	480	480	480	480	480	480	480	480	480
	10%	81	157	222	331	426	441	451	459	466	480	480	480	480	480	480	480	480	480	480	480	480	480	480	480	480	480	480	480	480	480	480	480	480	480	480	480
100%	-	5	10	15	20	26	31	38	43	48	51	61	68	74	80	91	97	103	108	112	123	128	133	137	140	144	147	150	153	156	158	160	163	165	166		
90%	-	6	11	17	23	28	37	43	47	51	62	70	76	82	95	101	107	112	123	129	134	138	142	146	149	152	155	158	161	163	165	167	185	190	195		
80%	-	7	13	20	27	35	42	47	52	64	72	79	92	99	106	112	124	130	135	140	144	148	152	155	158	161	164	166	182	189	194	200	205	210	215		
70%	-	9	16	23	32	41	47	52	66	75	83	97	105	112	125	131	137	142	147	151	155	159	162	165	167	186	193	200	206	211	216	221	226	302	306		
60%	-	11	20	28	39	47	53	69	79	94	103	111	125	133	139	145	150	155	159	162	166	183	191	199	206	212	218	223	301	305	310	314	318	322	325		
50%	-	14	25	37	47	53	72	83	100	110	126	134	142	148	154	159	163	167	187	197	205	213	219	226	304	309	314	319	323	327	331	334	338	341	344		
40%	-	19	32	46	60	76	95	108	125	136	145	152	158	163	180	192	203	212	221	300	307	313	319	324	329	333	337	341	345	420	423	426	429	431	434		
30%	-	26	44	62	81	104	125	138	149	157	164	185	199	212	222	304	312	319	326	332	337	342	346	422	426	429	433	436	438	441	443	446	448	450	452		
20%	-	41	67	98	126	143	156	165	195	213	227	311	321	330	338	344	422	427	432	436	440	443	447	449	452	454	457	459	461	463	464	466	467	480	480		
10%	-	83	135	159	197	226	319	335	347	428	436	443	449	453	457	461	464	467	480	480	480	480	480	480	480	480	480	480	480	480	480	480	480	480	480	480	
100%	-	-	5	8	11	15	18	22	26	28	34	38	42	45	48	50	52	61	66	70	74	78	81	91	95	99	103	106	109	112	121	125	128	131	-		
90%	-	-	6	9	13	17	21	25	28	34	39	43	46	49	51	53	61	65	70	74	78	82	92	97	101	105	109	112	121	125	129	132	135	138	141	-	
80%	-	-	7	11	16	20	25	28	35	40	44	47	50	53	64	70	75	79	83	95	100	104	108	111	122	126	130	134	137	140	143	146	148	151	-		
70%	-	-	9	14	18	23	28	35	41	45	49	52	63	70	75	80	91	97	103	107	112	122	127	131	135	139	142	146	149	151	154	156	159	161	-		
60%	-	-	11	17	23	28	36	42	47	51	61	69	76	81	94	100	106	111	122	128	133	137	141	145	149	152	155	157	160	162	165	167	183	188	-		
50%	-	-	14	21	28	37	44	49	53	68	76	83	97	104	110	122	129	134	139	144	148	152	155	159	162	164	167	184	191	197	202	208	213	217	-		
40%	-	-	19	27	38	46	52	66	76	91	100	108	122	130	137	142	148	152	157	160	164	167	186	193	201	207	213	219	224	301	306	310	314	318	-		
30%	-	-	27	40	49	64	77	94	106	122	132	140	147	153	158	163	167	188	198	207	214	222	300	306	312	317	321	326	330	334	337	340	344	347	-		
20%	-	-	43	60	79	102	122	136	147	155	162	181	195	208	219	300	309	316	323	329	334	339	344	420	424	427	431	434	437	439	442	444	446	448	-		
10%	-	-	96	130	151	164	198	220	309	322	333	342	422	429	435	440	444	448	452	455	458	460	463	465	467	480	480	480	480	480	480	480	480	480	-		
100%	-	-	-	5	7	10	12	15	18	20	22	26	27	31	34	38	40	43	45	47	49	51	52	60	64	67	70	74	76	79	81	90	93	96	-		
90%	-	-	-	6	9	11	14	17	20	23	26	28	32	36	40	42	45	47	49	51	53	62	66	69	73	76	79	82	91	94	97	101	104	106	-		
80%	-	-	-	7	10	13	17	20	23	27	30	35	38	42	45	47	50	52	53	64	68	72	76	79	82	92	96	99	103	106	109	112	120	124	-		
70%	-	-	-	9	12	16	20	23	27	32	37	41	44	47	50	52	61	66	71	75	79	83	93	97	101	105	108	112	121	125	128	131	134	137	-		
60%	-	-	-	11	16	20	25	28	35	40	44	47	50	53	64	69	75	79	83	94	99	104	108	111	121	126	130	133	137	140	143	145	148	151	-		
50%	-	-	-	14	20	25	30	37	43	47	50	53	67	73	78	83	95	101	106	111	121	126	131	135	139	143	146	149	152	154	157	159	161	163	-		
40%	-	-	-	19	26	33	41	46	51	61	70	77	83	97	103	109	121	127	132	137	142	146	150	153	156	159	162	164	167	183	189	195	200	205	-		
30%	-	-	-	27	37	45	51	65	75	83	98	107	120	128	135	141	146	151	155	159	162	165	182	190	197	204	210	216	221	226	303	307	311	315	-		
20%	-	-	-	43	52	71	83	102	113	130	139	147	153	159	164	181	192	202	211	219	227	305	311	317	322	326	331	335	339	342	345	420	423	426	-		
10%	-	-	-	96	123	141	154	164	190	209	223	308	318	327	335	342	420	425	430	434	438	441	445	448	450	453	455	457	459	461	463	465	466	480	-		

Run times in this table are approximate. They are based on new, fully charged standard battery modules at a temperature of 25°C (77°F) with 100% resistive UPS loading.

**Table 42 16-bay, single-phase, transformer-based unit Type R (& UPS model number 6 = R)**

UPS Rating	Load Level	# Battery Strings																																			
		1	2	3	4	5	6	7	8	9	10	11	12	13	14	15	16	17	18	19	20	21	22	23	24	25	26	27	28	29	30	31	32	33	34	35	
5 kVA/ 4.5 kW	100%	5	14	25	37	47	53	72	83	100	110	125	134	142	148	154	159	163	167	187	196	205	212	219	226	303	309	314	318	323	327	331	334	337	341	343	
	90%	5	16	27	41	50	67	80	98	109	126	135	143	150	156	161	165	185	195	204	213	220	227	305	311	317	321	326	330	334	338	341	344	347	422	425	
	80%	7	19	33	46	60	76	96	108	126	136	145	152	158	164	181	193	204	213	221	301	308	314	319	325	329	334	338	342	345	420	423	426	429	432	434	
	70%	8	22	38	50	71	92	107	126	137	147	155	161	166	190	202	213	222	302	310	317	323	328	333	338	342	346	421	425	428	431	434	436	439	441	443	
	60%	10	26	44	63	81	105	125	139	149	157	164	186	200	212	223	304	312	320	326	332	337	342	347	423	426	430	433	436	439	441	444	446	448	450	452	
	50%	13	32	50	76	102	125	140	152	160	180	197	212	224	306	316	324	331	337	342	420	424	428	432	436	439	442	444	447	449	452	454	456	457	459	461	
	40%	16	41	66	97	124	142	155	165	193	211	226	310	320	329	336	343	421	426	431	435	439	443	446	449	451	454	456	458	460	462	464	465	467	480	480	
	30%	22	50	91	125	146	160	189	212	301	316	327	337	345	424	430	436	440	444	448	452	455	457	460	462	464	466	480	480	480	480	480	480	480	480	480	
	20%	34	79	129	155	187	218	312	328	341	423	432	439	445	450	454	458	461	464	467	480	480	480	480	480	480	480	480	480	480	480	480	480	480	480	480	480
	10%	70	146	201	315	341	430	442	451	459	464	480	480	480	480	480	480	480	480	480	480	480	480	480	480	480	480	480	480	480	480	480	480	480	480	480	480
10 kVA/ 9 kW	100%	-	5	10	15	20	26	31	38	43	47	51	60	67	74	79	90	96	102	107	112	122	127	132	136	140	143	147	150	152	155	158	160	162	164	-	
	90%	-	6	11	17	22	28	36	42	47	51	61	69	75	81	93	100	106	111	122	127	132	137	141	145	148	151	154	157	160	162	164	166	182	188	-	
	80%	-	7	13	19	26	34	41	47	51	62	71	78	90	98	104	110	122	128	134	138	143	147	151	154	157	160	163	165	167	185	191	197	202	207	-	
	70%	-	9	16	23	31	40	47	51	65	74	81	95	103	110	122	129	135	141	145	150	154	157	160	163	166	183	190	196	202	208	213	218	223	227	-	
	60%	-	11	19	27	38	46	52	67	77	92	101	109	123	131	137	143	148	153	157	161	164	167	187	195	202	208	214	220	225	302	307	311	315	319	-	
	50%	-	14	25	36	46	52	70	81	98	108	123	132	139	146	152	157	161	165	182	192	200	208	215	222	300	305	310	315	320	324	328	331	335	338	-	
	40%	-	18	30	44	52	73	91	105	121	132	141	149	155	161	165	186	197	206	215	223	302	308	314	320	325	329	333	337	341	344	420	423	425	428	-	
	30%	-	25	42	53	77	100	120	134	144	153	160	166	191	204	215	225	305	313	320	326	332	337	341	346	422	425	428	432	434	437	440	442	444	446	-	
	20%	-	38	61	91	112	137	150	161	182	201	217	302	312	322	330	337	343	421	426	430	434	438	441	445	447	450	452	455	457	459	461	462	464	465	-	
	10%	-	75	124	151	167	210	305	322	336	347	427	435	441	446	451	455	458	462	464	467	480	480	480	480	480	480	480	480	480	480	480	480	480	480	480	-
15 kVA/ 13.5 kW	100%	-	5	8	11	15	18	22	26	28	33	38	41	45	47	50	52	60	65	70	74	77	81	90	94	98	102	105	109	112	121	124	127	130	-		
	90%	-	6	9	13	17	21	25	28	34	38	42	46	48	51	53	64	69	74	78	81	91	96	100	104	108	111	124	128	131	134	137	140	-	-		
	80%	-	7	11	16	20	25	28	34	39	43	47	50	52	63	69	74	78	82	93	98	103	107	111	121	125	129	132	136	139	142	145	147	150	-		
	70%	-	9	13	18	23	28	35	40	45	49	52	62	69	74	79	90	96	101	106	111	121	126	130	134	138	141	145	148	150	153	155	158	160	-		
	60%	-	11	17	22	28	36	42	47	51	60	68	75	81	93	99	105	110	121	127	132	136	140	144	148	151	154	157	159	162	164	166	181	186	-		
	50%	-	14	21	27	36	43	49	53	67	75	82	95	103	109	121	127	133	138	143	147	151	155	158	161	163	166	182	188	195	200	206	211	215	-		
	40%	-	18	27	37	45	51	65	75	83	99	107	120	128	135	141	146	151	155	159	162	166	182	190	197	204	210	216	221	226	303	308	312	316	-		
	30%	-	26	38	48	61	75	91	103	113	129	137	144	151	156	161	165	183	193	202	210	217	224	302	308	313	318	322	326	330	334	337	341	344	-		
	20%	-	41	52	75	97	111	131	142	151	158	164	186	199	211	221	302	309	317	323	329	334	339	343	347	423	426	429	432	435	438	440	442	445	-		
	10%	-	82	121	143	158	182	206	224	311	323	333	341	421	427	433	437	442	446	449	452	455	458	460	462	464	466	480	480	480	480	480	480	480	480	-	
20 kVA/ 18 kW	100%	-	-	5	7	10	12	15	18	20	22	26	27	31	34	38	40	43	45	47	49	51	52	60	64	67	70	73	76	79	81	90	93	-			
	90%	-	-	6	9	11	14	17	20	23	26	28	32	36	39	42	45	47	49	51	53	61	65	69	72	76	79	81	90	94	97	100	103	-			
	80%	-	-	7	10	13	17	20	23	27	30	34	38	42	44	47	49	51	53	63	68	72	75	79	82	91	95	99	102	105	108	111	120	-			
	70%	-	-	9	12	16	20	23	27	32	36	41	44	47	50	52	60	66	70	75	78	82	92	96	100	104	108	111	120	124	127	130	133	-			
	60%	-	-	11	16	20	25	28	34	39	43	47	50	52	63	69	74	78	82	93	98	103	107	111	120	124	128	132	136	139	142	145	147	-			
	50%	-	-	14	19	25	30	37	42	46	50	53	65	72	77	82	94	100	105	110	120	125	130	134	138	141	145	148	151	153	156	158	160	-			
	40%	-	-	19	26	32	40	46	50	60	68	76	82	95	102	108	113	125	131	136	140	144	148	152	155	158	161	163	165	180	186	192	197	-			
	30%	-	-	26	36	44	50	62	73	81	96	104	111	125	132	138	144	149	153	157	161	164	167	185	193	199	206	212	217	222	227	304	308	-			
	20%	-	-	42	50	68	80	99	110	126	136	144	150	156	161	166	186	196	205	213	221	300	306	312	317	322	326	331	334	338	342	345	420	-			
	10%	-	-	90	111	136	149	160	180	199	215	300	311	320	328	336	342	420	425	429	433	437	440	444	446	449	452	454	456	458	460	462	463	-			

Run times in this table are approximate. They are based on new, fully charged standard battery modules at a temperature of 25°C (77°F) with 100% resistive UPS loading.

Table 43 16-bay, single-phase, transformer-based unit Type B (& UPS model number 6 = B)

UPS Rating	Load Level	# Battery Strings																																				
		1	2	3	4	5	6	7	8	9	10	11	12	13	14	15	16	17	18	19	20	21	22	23	24	25	26	27	28	29	30	31	32	33	34	35		
5 kVA/ 4.5 kW	100%	-	5	15	26	38	47	60	74	90	102	111	127	136	143	149	155	160	164	180	190	199	207	215	222	300	306	311	316	320	325	329	332	336	339	342		
	90%	-	6	17	28	42	51	69	81	100	111	128	137	145	152	157	162	167	188	198	208	216	223	302	308	314	319	324	328	332	336	340	343	346	421	424		
	80%	-	7	19	34	47	63	78	98	110	128	139	147	154	160	165	186	197	208	217	225	304	311	317	322	327	332	336	340	344	347	423	426	428	431	434		
	70%	-	9	23	40	51	74	95	110	129	141	150	157	163	183	196	208	218	227	307	314	321	327	332	337	341	345	421	425	428	431	434	436	439	441	443		
	60%	-	11	27	46	67	91	109	130	143	153	160	167	194	208	219	301	310	318	325	331	337	342	347	423	427	430	434	437	439	442	444	447	449	451	453		
	50%	-	14	35	52	80	107	131	145	156	164	190	207	221	304	314	323	330	337	343	420	425	429	433	437	440	443	446	448	451	453	455	457	459	461	462		
	40%	-	18	44	73	104	132	149	160	185	206	222	308	319	329	337	344	423	428	433	437	441	444	448	451	453	456	458	460	462	464	466	467	480	480	480		
	30%	-	25	53	100	134	154	167	205	226	314	327	337	346	426	433	442	443	447	451	454	457	460	462	465	467	480	480	480	480	480	480	480	480	480	480	480	
	20%	-	40	94	140	163	206	306	326	340	424	433	440	447	452	457	460	464	467	480	480	480	480	480	480	480	480	480	480	480	480	480	480	480	480	480	480	480
	10%	-	81	157	222	331	426	441	451	459	466	480	480	480	480	480	480	480	480	480	480	480	480	480	480	480	480	480	480	480	480	480	480	480	480	480	480	480
100%	-	-	5	10	15	20	26	31	38	43	48	51	61	68	74	80	91	97	103	108	112	123	128	133	137	140	144	147	150	153	156	158	160	163	165			
90%	-	-	6	11	17	23	28	37	43	47	51	62	70	76	82	95	101	107	112	123	129	134	138	142	146	149	152	155	158	161	163	165	167	185	190			
80%	-	-	7	13	20	27	35	42	47	52	64	72	79	92	99	106	112	124	130	135	140	144	148	152	155	158	161	164	166	182	189	194	200	205	210			
70%	-	-	9	16	23	32	41	47	52	66	75	83	97	105	112	125	131	137	142	147	151	155	159	162	165	167	186	193	200	206	211	216	221	226	302			
60%	-	-	11	20	28	39	47	53	69	79	94	103	111	125	133	139	145	150	155	159	162	166	183	191	199	206	212	218	223	301	305	310	314	318	322			
50%	-	-	14	25	37	47	53	72	83	100	110	126	134	142	148	154	159	163	167	187	197	205	213	219	226	304	309	314	319	323	327	331	334	338	341			
40%	-	-	19	32	46	60	76	95	108	125	136	145	152	158	163	180	192	203	212	221	300	307	313	319	324	329	333	337	341	345	420	423	426	429	431			
30%	-	-	26	44	62	81	104	125	138	149	157	164	185	199	212	222	304	312	319	326	332	337	342	346	422	426	429	433	436	438	441	443	446	448	450			
20%	-	-	41	67	98	126	143	156	165	195	213	227	311	321	330	338	344	422	427	432	436	440	443	447	449	452	454	457	459	461	463	464	466	467	480			
10%	-	-	83	135	159	197	226	319	335	347	428	436	443	449	453	457	461	464	467	480	480	480	480	480	480	480	480	480	480	480	480	480	480	480	480	480		
100%	-	-	-	5	8	11	15	18	22	26	28	34	38	42	45	48	50	52	61	66	70	74	78	81	91	95	99	103	106	109	112	121	125	128	-			
90%	-	-	-	6	9	13	17	21	25	28	34	39	43	46	49	51	53	65	70	74	78	82	92	92	101	105	109	112	121	125	129	132	135	138	-			
80%	-	-	-	7	11	16	20	25	28	35	40	44	47	50	53	64	70	75	79	83	95	100	104	108	112	122	126	130	134	140	143	146	148	-				
70%	-	-	-	9	14	18	23	28	35	41	45	49	52	63	70	75	80	91	97	103	107	112	122	127	131	135	139	142	146	149	151	154	156	159	-			
60%	-	-	-	11	17	23	28	36	42	47	51	61	69	76	81	94	100	106	111	122	128	133	137	141	145	149	152	155	157	160	162	165	167	183	-			
50%	-	-	-	14	21	28	37	44	49	53	68	76	83	97	104	110	122	129	134	139	144	148	152	155	159	162	164	167	184	191	197	202	208	213	-			
40%	-	-	-	19	27	38	46	52	66	76	91	100	108	122	130	137	142	148	152	157	160	164	167	186	193	201	207	213	219	224	301	306	310	314	-			
30%	-	-	-	27	40	49	64	77	94	106	122	132	140	147	153	158	163	167	188	198	207	214	222	300	306	312	317	321	326	330	334	337	340	344	-			
20%	-	-	-	43	60	79	102	122	136	147	155	162	181	195	208	219	300	309	316	323	329	334	339	344	420	424	427	431	434	437	439	442	444	446	-			
10%	-	-	-	96	130	151	164	198	220	309	322	333	342	422	429	435	440	444	448	452	455	458	460	463	465	467	480	480	480	480	480	480	480	480	480	-		
100%	-	-	-	-	5	7	10	12	15	18	20	22	26	27	31	34	38	40	43	45	47	49	51	52	60	64	67	70	74	76	79	81	90	93	-			
90%	-	-	-	-	6	9	11	14	17	20	23	26	28	32	36	40	42	45	47	49	51	53	62	66	69	73	76	79	82	91	94	97	101	104	-			
80%	-	-	-	-	7	10	13	17	20	23	27	30	35	38	42	45	47	50	52	53	64	68	72	76	79	82	92	96	99	103	106	109	112	120	-			
70%	-	-	-	-	9	12	16	20	23	27	32	37	41	44	47	50	52	61	66	71	75	79	83	93	97	101	105	108	112	121	125	128	131	134	-			
60%	-	-	-	-	11	16	20	25	28	35	40	44	50	53	67	73	83	95	104	106	111	121	126	131	135	139	143	146	149	152	154	157	159	161	-			
50%	-	-	-	-	14	20	25	30	37	43	47	50	77	83	97	103	109	121	127	132	137	142	146	150	153	156	159	162	164	167	183	189	195	200	-			
40%	-	-	-	-	19	26	33	41	46	51	61	70	77	83	98	107	120	128	135	141	146	151	155	159	162	165	182	190	197	204	210	216	221	226	303			
30%	-	-	-	-	27	37	45	51	65	75	83	98	107	120	128	135	141	146	151	155	159	162	165	182	190	197	204	210	216	221	226	303	307	311	-			
20%	-	-	-	-	43	52	71	83	102	113	130	139	147	153	159	164	181	192	202	211	219	227	305	311	317	322	326	331	335	339	342	345	420	423	-			
10%	-	-	-	-	96	123	141	154	164	190	209	223	308	318	327	335	342	420	425	430	434	438	441	445	448	450	453	455	457	459	461	463	465	466	-			

Run times in this table are approximate. They are based on new, fully charged standard battery modules at a temperature of 25°C (77°F) with 100% resistive UPS loading.





## 7.5 Estimated Battery Run Times

### 7.5.1 Tables for UPS Model Number Where Digits 1-3 are AS5 or ASE

**Table 45 10-bay, two-phase, no transformer unit Type N (& UPS model number 6 = N)**

UPS Rating	Load Level	# Battery Strings																																		
		1	2	3	4	5	6	7	8	9	10	11	12	13	14	15	16	17	18	19	20	21	22	23	24	25	26	27	28	29	30	31	32			
5 kVA/ 4.5 kW	100%	5	15	26	39	48	62	75	92	104	113	129	138	145	151	157	161	165	184	194	203	211	218	225	303	309	314	319	323	327	331	335	339	342	346	421
	90%	6	18	28	43	52	71	83	103	113	130	139	147	154	159	164	182	193	203	212	220	227	305	311	317	322	327	331	335	339	342	346	421			
	80%	7	20	36	48	66	81	101	113	132	142	150	157	162	167	192	203	213	222	301	309	315	321	326	331	336	340	344	347	422	426	428	431			
	70%	9	25	42	53	77	99	113	133	144	153	160	166	190	203	214	224	305	312	319	325	331	336	341	345	421	425	428	431	434	437	439	442			
	60%	11	28	48	71	96	113	135	147	156	164	187	203	216	227	308	317	324	331	337	342	347	423	427	431	434	438	440	443	446	448	450	452			
	50%	15	38	61	91	112	137	150	161	182	201	217	302	313	322	330	337	343	421	426	430	434	438	442	445	447	450	452	455	457	459	461	462			
	40%	20	47	79	111	139	155	166	199	218	305	318	328	337	345	423	429	434	439	443	446	450	453	455	458	460	462	464	466	480	480	480	480			
	30%	27	67	109	143	161	195	220	311	326	337	347	427	434	440	445	449	453	457	460	462	465	467	480	480	480	480	480	480	480	480	480	480	480		
	20%	45	106	150	188	225	321	339	424	434	442	449	454	459	463	467	480	480	480	480	480	480	480	480	480	480	480	480	480	480	480	480	480	480	480	
	10%	101	167	314	347	438	451	460	467	480	480	480	480	480	480	480	480	480	480	480	480	480	480	480	480	480	480	480	480	480	480	480	480	480	480	
	100%	-	5	10	16	21	26	32	39	44	48	52	62	69	76	81	93	99	104	109	120	125	130	134	138	142	145	149	152	154	157	159	162			
	90%	-	6	11	18	23	28	37	43	48	52	64	71	78	83	96	103	108	113	125	130	135	140	144	147	151	154	157	159	162	164	166	182			
	80%	-	7	14	20	27	36	43	48	52	66	74	81	94	101	108	113	126	132	137	142	146	150	153	157	160	162	165	167	186	192	198	203			
	70%	-	9	17	25	33	42	48	53	68	77	91	100	107	120	127	134	139	144	149	153	157	160	163	166	183	191	197	204	209	215	220	225			
	60%	-	12	21	30	41	48	60	72	81	97	106	120	128	136	142	148	153	157	161	164	180	189	197	204	211	217	222	300	305	309	314	318			
50%	-	15	26	39	48	62	75	92	104	113	130	138	145	151	157	161	166	185	195	203	211	219	225	303	309	314	319	323	328	331	335	338				
40%	-	20	35	48	65	80	101	113	131	141	149	156	162	167	191	202	212	221	301	308	314	320	326	330	335	339	343	347	422	425	428	431				
30%	-	28	47	69	94	111	133	145	155	162	183	199	212	223	305	314	322	328	334	340	345	421	425	429	433	436	439	441	444	446	449	451				
20%	-	46	76	108	136	152	164	193	213	301	314	325	334	342	420	426	432	436	440	444	448	451	453	456	458	461	463	465	466	480	480	480				
10%	-	104	148	184	222	319	336	422	432	441	447	453	458	462	466	480	480	480	480	480	480	480	480	480	480	480	480	480	480	480	480	480	480			
100%	-	-	5	8	11	15	18	22	26	28	35	39	42	45	48	50	53	62	67	71	75	79	82	92	97	101	104	107	111	113	123	-				
90%	-	-	6	10	14	18	21	26	28	35	40	43	47	49	52	61	67	71	76	80	83	94	99	103	107	110	113	123	127	131	134	-				
80%	-	-	8	12	16	21	26	30	36	41	45	48	51	60	66	72	77	81	92	97	102	106	110	120	124	128	132	136	139	142	145	-				
70%	-	-	9	14	19	25	30	37	42	46	50	53	65	72	77	82	94	100	105	110	120	125	130	134	138	141	145	148	151	153	156	-				
60%	-	-	12	18	23	30	38	44	48	52	64	72	78	90	97	104	109	120	126	131	136	140	144	148	151	154	157	160	162	165	167	-				
50%	-	-	16	22	30	39	46	51	62	72	79	93	101	108	120	127	133	138	143	148	152	155	159	162	165	167	185	192	198	204	209	-				
40%	-	-	20	28	40	48	53	71	80	96	105	113	128	135	141	147	152	156	160	164	167	187	195	203	209	216	221	227	304	308	313	-				
30%	-	-	28	43	51	70	82	101	112	129	138	146	152	158	163	167	190	200	209	217	224	303	309	315	320	325	329	333	337	341	344	-				
20%	-	-	46	67	92	109	131	143	153	161	167	195	209	220	302	311	319	326	332	338	343	347	423	427	431	434	437	440	443	445	447	-				
10%	-	-	106	140	158	188	214	306	321	333	343	424	431	437	442	447	451	454	458	460	463	465	480	480	480	480	480	480	480	480	480	480	480	-		

Run times in this table are approximate. They are based on new, fully charged standard battery modules at a temperature of 25°C (77°F) with 100% resistive UPS loading.

**Table 46 10-bay, two-phase, no transformer unit Type R (& UPS model number 6 = R)**

UPS Rating	Load Level	# Battery Strings																																
		1	2	3	4	5	6	7	8	9	10	11	12	13	14	15	16	17	18	19	20	21	22	23	24	25	26	27	28	29	30	31	32	
5 kVA/ 4.5 kW	100%	5	16	26	39	48	62	76	93	104	120	130	138	145	152	157	162	166	185	195	204	212	219	226	304	309	314	319	324	328	332	335	339	
	90%	6	18	28	43	52	71	83	102	113	130	139	147	154	159	164	181	193	203	211	219	227	305	311	317	322	327	331	335	339	342	345	420	
	80%	7	20	35	48	65	80	100	113	131	141	149	156	162	167	190	202	212	221	301	308	314	320	325	330	335	339	343	346	422	425	428	431	
	70%	9	25	41	52	76	98	112	132	143	152	159	165	188	201	212	222	303	311	318	324	330	335	340	344	420	424	427	430	433	436	438	441	
	60%	11	28	47	69	94	111	133	145	155	163	183	199	212	224	306	314	322	329	335	340	345	421	426	429	433	436	439	442	444	447	449	451	
	50%	14	37	53	83	110	134	148	159	167	196	212	226	309	318	327	334	340	346	423	428	432	436	439	443	445	448	451	453	455	457	459	461	
	40%	19	46	76	108	136	152	163	192	212	300	313	324	333	341	420	426	431	436	440	444	447	450	453	456	458	460	462	464	466	480	480	480	
	30%	26	62	104	138	157	185	212	304	319	332	342	422	429	436	441	446	450	453	457	460	462	465	467	480	480	480	480	480	480	480	480	480	480
	20%	42	99	144	166	214	312	331	345	428	437	444	450	455	459	463	466	480	480	480	480	480	480	480	480	480	480	480	480	480	480	480	480	480
	10%	91	160	301	337	430	444	455	462	480	480	480	480	480	480	480	480	480	480	480	480	480	480	480	480	480	480	480	480	480	480	480	480	480
100%	-	5	10	16	21	26	32	39	44	48	52	63	70	76	81	93	99	105	109	120	125	130	135	139	142	146	149	152	155	157	160	-		
90%	-	6	12	18	23	30	38	44	48	52	64	72	78	90	97	103	109	120	126	131	136	140	144	148	151	154	157	160	162	165	167	-		
80%	-	8	14	21	27	36	43	48	52	66	74	81	94	102	108	120	126	132	137	142	146	150	154	157	160	163	165	180	187	193	199	-		
70%	-	9	17	25	33	42	48	53	68	77	91	100	107	120	127	134	139	144	149	153	157	160	163	166	183	191	197	204	209	215	220	-		
60%	-	11	20	28	40	48	53	71	80	96	105	113	128	135	141	147	152	156	160	164	167	187	195	203	209	216	221	227	304	308	313	-		
50%	-	15	26	38	48	61	74	91	103	112	128	137	144	150	156	160	165	182	192	201	209	216	223	301	307	312	317	322	326	330	333	-		
40%	-	20	34	47	63	78	98	111	129	139	147	154	160	165	186	198	208	217	225	305	311	317	323	328	332	337	341	344	420	423	426	-		
30%	-	27	46	67	91	109	130	143	152	160	167	194	207	219	301	310	318	325	331	337	342	346	423	427	430	433	436	439	442	444	447	-		
20%	-	44	73	105	133	149	161	187	207	224	309	320	330	338	345	423	429	433	438	442	445	448	451	454	456	459	461	463	465	466	480	-		
10%	-	100	145	167	216	314	333	346	429	438	445	451	456	460	464	467	480	480	480	480	480	480	480	480	480	480	480	480	480	480	480	480	-	
100%	-	-	5	8	11	15	18	22	26	28	35	39	42	45	48	50	53	62	67	71	75	79	82	92	97	100	104	107	111	113	123	-		
90%	-	-	6	10	14	18	22	26	30	35	40	44	47	50	52	61	67	72	76	80	90	94	99	103	107	110	120	124	127	131	134	-		
80%	-	-	8	12	16	21	26	30	36	41	45	48	51	60	66	72	77	81	92	97	102	106	110	120	124	128	132	136	139	142	145	-		
70%	-	-	9	14	19	25	30	37	42	46	50	53	65	72	77	82	94	100	105	110	120	125	130	134	138	141	145	148	151	153	156	-		
60%	-	-	12	18	23	30	38	44	48	52	64	72	78	90	97	103	109	120	126	131	136	140	144	148	151	154	157	160	162	164	167	-		
50%	-	-	15	22	28	39	45	50	62	71	79	92	100	107	113	126	132	138	143	147	151	155	158	161	164	167	184	191	197	203	208	-		
40%	-	-	20	28	40	47	53	70	79	95	104	112	126	134	140	146	151	155	159	163	166	185	193	200	207	214	219	225	302	307	311	-		
30%	-	-	28	42	50	68	80	99	110	126	136	144	151	156	161	166	186	196	205	214	221	300	306	312	317	322	327	331	335	338	342	-		
20%	-	-	45	65	83	107	128	141	151	159	165	190	204	216	226	307	315	322	329	334	340	344	421	425	428	432	435	438	440	443	445	-		
10%	-	-	102	136	155	180	207	300	316	329	339	420	427	433	439	444	448	452	455	458	461	463	466	480	480	480	480	480	480	480	480	480	-	

Run times in this table are approximate. They are based on new, fully charged standard battery modules at a temperature of 25°C (77°F) with 100% resistive UPS loading.

Table 47 10-bay, two-phase, no transformer unit Type B (& UPS model number 6 = B)

UPS Rating	Load Level	# Battery Strings																																				
		1	2	3	4	5	6	7	8	9	10	11	12	13	14	15	16	17	18	19	20	21	22	23	24	25	26	27	28	29	30	31	32					
5 kVA/ 4.5 kW	100%	-	5	15	26	39	48	62	75	92	104	113	129	138	145	151	157	161	165	184	194	203	211	218	225	303	309	314	319	323	327	331	335	339	342	346		
	90%	-	6	18	28	43	52	71	83	103	113	130	139	147	154	159	164	182	193	203	212	220	227	305	311	317	322	327	331	335	339	342	346	346	346	346		
	80%	-	7	20	36	48	66	81	101	113	132	142	150	157	162	167	192	203	213	222	301	309	315	321	326	331	336	340	344	347	422	422	426	426	428	428		
	70%	-	9	25	42	53	77	99	113	133	144	153	160	166	190	203	214	224	305	312	319	325	331	336	341	345	421	425	428	431	434	434	437	439	439	439	439	
	60%	-	11	28	48	71	96	113	135	147	156	164	187	203	216	227	308	317	324	331	337	342	347	423	427	431	434	438	440	443	446	446	448	448	448	448	448	
	50%	-	15	38	61	91	112	137	150	161	182	201	217	302	313	322	330	337	343	421	426	430	434	438	442	445	447	450	452	455	457	459	461	461	461	461	461	
	40%	-	20	47	79	111	139	155	166	199	218	305	318	328	337	345	423	429	434	439	443	446	450	453	455	458	460	462	464	466	468	480	480	480	480	480	480	
	30%	-	27	67	109	143	161	195	220	311	326	337	347	427	434	440	445	449	453	457	460	462	465	467	480	480	480	480	480	480	480	480	480	480	480	480	480	480
	20%	-	45	106	150	188	225	321	339	424	434	442	449	454	459	463	467	480	480	480	480	480	480	480	480	480	480	480	480	480	480	480	480	480	480	480	480	480
	10%	-	101	167	314	347	438	451	460	467	480	480	480	480	480	480	480	480	480	480	480	480	480	480	480	480	480	480	480	480	480	480	480	480	480	480	480	480
100%	-	-	5	10	16	21	26	32	39	44	48	52	62	69	76	81	93	99	104	109	120	125	130	134	138	142	145	149	152	154	157	159	162	164	166	166		
90%	-	-	6	11	18	23	28	37	43	48	52	64	71	78	83	96	103	108	113	125	130	135	140	144	147	151	154	157	159	162	164	166	166	166	166	166		
80%	-	-	7	14	20	27	36	43	48	52	66	74	81	94	101	108	113	126	132	137	142	146	150	153	157	160	162	165	167	186	192	198	198	198	198	198		
70%	-	-	9	17	25	33	42	48	53	68	77	91	100	107	120	127	134	139	144	149	153	157	160	163	166	168	183	191	197	204	209	215	220	220	220	220		
60%	-	-	12	21	30	41	48	60	72	81	97	106	120	128	136	142	148	153	157	161	164	180	189	197	204	211	217	222	300	305	309	314	314	314	314	314		
50%	-	-	15	26	39	48	62	75	92	104	113	130	138	145	151	157	161	166	185	195	203	211	219	225	303	309	314	319	323	328	331	335	335	335	335	335		
40%	-	-	20	35	48	65	80	101	113	131	141	149	156	162	167	191	202	212	221	301	308	314	320	326	330	335	339	343	347	422	425	428	428	428	428	428		
30%	-	-	28	47	69	94	111	133	145	155	162	183	199	212	223	305	314	322	328	334	340	345	421	425	429	433	436	439	441	444	446	449	449	449	449	449	449	
20%	-	-	46	76	108	136	152	164	193	213	301	314	325	334	342	420	426	432	436	440	444	448	451	453	456	458	461	463	465	466	468	480	480	480	480	480	480	
10%	-	-	104	148	184	222	319	336	422	432	441	447	453	458	462	466	480	480	480	480	480	480	480	480	480	480	480	480	480	480	480	480	480	480	480	480	480	

Run times in this table are approximate. They are based on new, fully charged standard battery modules at a temperature of 25°C (77°F) with 100% resistive UPS loading.

**Table 48 10-bay, two-phase, no transformer unit Type F (& UPS model number 6 = F)**

UPS Rating	Load Level	# Battery Strings																																	
		1	2	3	4	5	6	7	8	9	10	11	12	13	14	15	16	17	18	19	20	21	22	23	24	25	26	27	28	29	30	31	32	33	
5 kVA/ 4.5 kW	100%	-	5	16	26	39	48	62	76	93	104	120	130	138	145	152	157	162	166	185	195	204	212	219	226	304	309	314	319	324	328	332	335		
	90%	-	6	18	28	43	52	71	83	102	113	130	139	147	154	159	164	181	193	203	211	219	227	305	311	317	322	327	331	335	339	342	345		
	80%	-	7	20	35	48	65	80	100	113	131	141	149	156	162	167	190	202	212	221	301	308	314	320	325	330	335	339	343	346	422	425	428		
	70%	-	9	25	41	52	76	98	112	132	143	152	159	165	188	201	212	222	303	311	318	324	330	335	340	344	420	424	427	430	433	436	438		
	60%	-	11	28	47	69	94	111	133	145	155	163	183	199	212	224	306	314	322	329	335	340	345	421	426	429	433	436	439	442	444	447	449		
	50%	-	14	37	53	83	110	134	148	159	167	196	212	226	309	318	327	334	340	346	423	428	432	436	439	443	445	448	451	453	455	457	459		
	40%	-	19	46	76	108	136	152	163	192	212	300	313	324	333	341	420	426	431	436	440	444	447	450	453	456	458	460	462	464	466	480	480		
	30%	-	26	62	104	138	157	185	212	304	319	332	342	422	429	436	441	446	450	453	457	460	462	465	467	480	480	480	480	480	480	480	480	480	
	20%	-	42	99	144	166	214	312	331	345	428	437	444	450	455	459	463	466	480	480	480	480	480	480	480	480	480	480	480	480	480	480	480	480	480
	10%	-	91	160	301	337	430	444	455	462	480	480	480	480	480	480	480	480	480	480	480	480	480	480	480	480	480	480	480	480	480	480	480	480	480
100%	-	-	5	10	16	21	26	32	39	44	48	52	63	70	76	81	93	99	105	109	120	125	130	135	139	142	146	149	152	155	157	-	-		
90%	-	-	6	12	18	23	30	38	44	48	52	64	72	78	90	97	103	109	120	126	131	136	140	144	148	151	154	157	160	162	165	-	-		
80%	-	-	8	14	21	27	36	43	48	52	66	74	81	94	102	108	120	126	132	137	142	146	150	154	157	160	163	165	180	187	193	-	-		
70%	-	-	9	17	25	33	42	48	53	68	77	91	100	107	120	127	134	139	144	149	153	157	160	163	166	183	191	197	204	209	215	-	-		
60%	-	-	11	20	28	40	48	53	71	80	96	105	113	128	135	141	147	152	156	160	164	167	187	195	203	209	216	221	227	304	308	-	-		
50%	-	-	15	26	38	48	61	74	91	103	112	128	137	144	150	156	160	165	182	192	201	209	216	223	301	307	312	317	322	326	330	-	-		
40%	-	-	20	34	47	63	78	98	111	129	139	147	154	160	165	186	198	208	217	225	305	311	317	323	328	332	337	341	344	420	423	-	-		
30%	-	-	27	46	67	91	109	130	143	152	160	167	194	207	219	301	310	318	325	331	337	342	346	423	427	430	433	436	439	442	444	-	-		
20%	-	-	44	73	105	133	149	161	187	207	224	309	320	330	338	345	423	429	433	438	442	445	448	451	454	456	459	461	463	465	466	-	-		
10%	-	-	100	145	167	216	314	333	346	429	438	445	451	456	460	464	467	480	480	480	480	480	480	480	480	480	480	480	480	480	480	480	480	480	

Run times in this table are approximate. They are based on new, fully charged standard battery modules at a temperature of 25°C (77°F) with 100% resistive UPS loading.

## NOTES







# Ensuring The High Availability Of Mission-Critical Data And Applications.

Emerson Network Power, a business of Emerson (NYSE:EMR), is the global leader in enabling *Business-Critical Continuity™* from grid to chip for telecommunication networks, data centers, health care and industrial facilities. Emerson Network Power provides innovative solutions and expertise in areas including AC and DC power and precision cooling systems, embedded computing and power, integrated racks and enclosures, power switching and controls, infrastructure management, and connectivity. All solutions are supported globally by local Emerson Network Power service technicians. Liebert AC power, precision cooling and monitoring products and services from Emerson Network Power deliver Efficiency Without Compromise™ by helping customers optimize their data center infrastructure to reduce costs and deliver high availability.

While every precaution has been taken to ensure the accuracy and completeness of this literature, Liebert Corporation assumes no responsibility and disclaims all liability for damages resulting from use of this information or for any errors or omissions.

© 2012 Liebert Corporation

All rights reserved throughout the world. Specifications subject to change without notice.

® Liebert is a registered trademark of Liebert Corporation.

All names referred to are trademarks or registered trademarks of their respective owners.

SL-55010\_REV0\_08-13

## Technical Support / Service

### Web Site

[www.liebert.com](http://www.liebert.com)

### Monitoring

[liebert.monitoring@emerson.com](mailto:liebert.monitoring@emerson.com)

800-222-5877

Outside North America: +00800 1155 4499

### Single-Phase UPS & Server Cabinets

[liebert.upstech@emerson.com](mailto:liebert.upstech@emerson.com)

800-222-5877

Outside North America: +00800 1155 4499

### Three-Phase UPS & Power Systems

800-543-2378

Outside North America: 614-841-6598

### Environmental Systems

800-543-2778

Outside the United States: 614-888-0246

### Locations

#### United States

1050 Dearborn Drive

P.O. Box 29186

Columbus, OH 43229

#### Europe

Via Leonardo Da Vinci 8

Zona Industriale Tognana

35028 Piove Di Sacco (PD) Italy

+39 049 9719 111

Fax: +39 049 5841 257

#### Asia

29/F, The Orient Square Building

F. Ortigas Jr. Road, Ortigas Center

Pasig City 1605

Philippines

+63 2 687 6615

Fax: +63 2 730 9572

## Emerson Network Power.

The global leader in enabling *Business-Critical Continuity™*

- |                |  |                              |                               |
|----------------|--|------------------------------|-------------------------------|
| ■ AC Power     | ■ Embedded Computing                     | ■ Outside Plant              | ■ Racks & Integrated Cabinets |
| ■ Connectivity | ■ Embedded Power                         | ■ Power Switching & Controls | ■ Services                    |
| ■ DC Power     | ■ Infrastructure Management & Monitoring | ■ Precision Cooling          | ■ Surge Protection            |