



uni jet

ИБП APC Silcon 480 кВт 400 В - руководство по установке. Юниджет

Постоянная ссылка на страницу: <https://www.uni-jet.com/catalog/ibp/online-ibp/apc-silcon/>



APC Silcon 480kW 400V UPS Installation Guide



APC
www.apcc.com

Copyright 2000 APC Denmark ApS
This manual is subject to change without
notice and does not represent a commitment
on the part of the vendor



Thank You!

Thank you for choosing the APC Silcon Series UPS. Please read this Installation Guide thoroughly prior to installing the system. It provides important information on safe and efficient installation.

The installation and use of this product must comply with national, federal, state, municipal and local codes.

Safety Symbols used in this manual



WARNING! Indicates a hazard which, if not avoided, could result in injury or death.



CAUTION! Indicates a hazard which, if not avoided, could result in damage to the product or other property.

NOTICE! Read and pay attention to this important information.



WARNING!

This UPS unit contains hazardous AC and DC voltages. Only qualified electricians should install the UPS, AC line and external batteries, and must be familiar with batteries and battery installation.

Before installing, maintaining or servicing the UPS, shut off the UPS and disconnect all sources of AC and DC power.

As the UPS has no built-in disconnection devices to switch off external AC and DC input power, ensure that disconnection devices are provided as separate parts in connection with the installation!

The installer must provide each external disconnecting device for this UPS system with labels with the following text:

“Isolate the Uninterruptible Power Supply (UPS) as instructed in this guide before working on circuit”

AC and/or DC voltage will always involve a potential risk of AC voltage at UPS output generated from either batteries or mains. To avoid equipment damage or personal injury, always assume that there may be voltage at UPS output.

This system is equipped with an auto-start function. If activated, the system may start without warning. Refer to the “Programming” section of this guide for information on de-activation.

TEST BEFORE YOU TOUCH!

To reduce the risk of fire or electric shocks, install the UPS and external batteries in a temperature and humidity controlled indoor area, free of conductive contaminants.

UPS batteries are high-current sources. Shorting battery terminals or DC terminals, DC busbars can cause severe arcing, equipment damage and injury. A short circuit can cause a battery to explode. Always wear protective clothing and eye protection and use insulated tools when working on batteries.



CAUTION!

This unit contains components sensitive to electrostatic discharge (ESD). If you do not follow the ESD procedures, you may cause severe damage to electronic components.

Contents

1.0	Introduction	5
1.1	Tools and Equipment	5
2.0	Unpacking	6
3.0	Installation	7
3.1	Requirements on Site	7
3.1.1	Cabinet Dimensions	7
3.2	Footprint	8
3.2.1	1900mm Cabinet for 480kW UPS	8
3.2.2	1600mm Cabinet for 480kW Isolation Transformer	8
4.0	External Connection	9
4.1	Connecting the UPS	9
4.2	System Integration Interface	11
4.2.1	Connections	12
4.3	Parallel Board	13
4.4	Relay Board	16
4.4.1	Relay Board/Relay Functions	17
4.5	Communication Interface Board	19
4.5.1	Connections	19
4.6	Connecting of APC Silcon Tripel Chassis	20
4.7	APC Silcon Triple Chassis	21
4.7.1	Safety Warnings	21
4.7.2	Product Description	21
4.7.3	Installing Management Peripherals	22
4.7.4	Powering the APC Silcon Triple Chassis	24
4.7.5	Troubleshooting	25
4.7.6	Product Specifications	26
4.8	APC Silcon Battery Cabinets	29
4.9	Battery Breaker Box/Fuse-box	31
4.9.1	Battery Breaker Box	32
4.9.2	APC Battery Breaker Box Connection Diagram	33
4.9.3	UPS with External Battery in Battery Breaker Box/Fuse-box Configuration	34
5.0	Programming Parameters	35
5.1	Parameters	35
5.1.1	Programming Keys	36
5.1.2	Programming Example - Switch to Bypass Operation	37
5.2	System Configuration	37
5.2.1	Programming Example - Change Charge Voltage to 446	39
5.2.2	Programming Example - Change to Output Isolation Transformer available	40
5.3	Programming Parameters for Advanced Parallel Operation	41
5.3.1	Description of Settings	41
5.3.2	Programming example	42
5.4	Battery Monitor	42
5.4.1	Installation of new batteries	42
6.0	Options/Accessories	43
6.1	Service Bypass Panel for Single Operation	43
6.1.1	Wiring up UPS with SBP in TN-C-S Network	44
6.1.2	Wiring up UPS with SBP in TN-S Network	44
6.1.3	Operating The External Service Bypass Switch	45
6.2	Service Bypass Panel for Parallel Redundant Operation	47
6.2.1	Two Parallel Systems with Service Bypass Panel	48
6.2.2	Parallel/Redundant Operation with Service Bypass Panel and External Battery via MCCB	49
6.2.3	Operating External Service Bypass Switch for Parallel Systems	50
6.2.4	Isolating One UPS for Service/Maintenance	54
6.2.5	Switching Back to Normal Parallel/Redundant Operation	55
6.3	Intersystem Synchronization Unit	56
6.4	Remote Display	57

990-4053

6.4.1	Extension of Remote Display Communication Distance	57
6.4.2	Remote Display Installation	59
6.4.3	Remote Display Use	60
6.5	Isolation Transformer	61
6.5.1	Connecting Isolation Transformer	62
6.5.2	Wiring up UPS with External Yyn0 Isolation Transformer at Output	64
6.5.3	Wiring up UPS with External Yyn0 Isolation Transformer at Input	65
6.5.4	Wiring up UPS with External Optional Dzn0 Isolation Transformer at Input	66
6.5.5	Wiring up UPS with External Optional Dzn0 Isolation Transformer at Output	67
6.5.6	Wiring up UPS with External Optional Dyn11 Isolation Transformer at Input	68
7.0	System Specifications	69
7.1	Technical Data	69
7.2	Dimensions / Weight	69
8.0	Warranty	70
8.1	APC Silcon Series Limited Factory Warranty	70
9.0	Appendix	71
9.1	Table 1. Installation Planning Data	71
10.0	How to Contact APC	73

1.0 Introduction

Power regulation varies from country to country, and information given in this installation guide can therefore only be of a general nature. Electricians should therefore always refer to national and local electrical codes prior to installing the UPS system.

1.1 Tools and Equipment

**CAUTION!**

Heavy equipment. To prevent personal injury or equipment damage, take extreme care when handling and transporting UPS cabinet and equipment.

**CAUTION!**

Ensure that front doors are in place and that internal front cover is fastened by screws before attempting to lift or transport the system.

This section lists all tools and equipment required to install all UPS configurations. See also section 4.0 of this guide for further details on connection.

Tools:

- 10mm socket
- 13mm socket-deep
- 17mm socket
- 19mm socket-deep
- 19mm combo wrench
- Small flat head/regular screwdriver
- #3 philips screwdriver
- Compression lug crimping tool
- Knock-out set (for glands)

Equipment:

- Compression lugs for cable terminations
- Cable to Service Bypass Panel from system feeder
- Cable to UPS input from Service Bypass Panel
- Cable to Service Bypass Panel from UPS output
- Cable from Service Bypass Panel to customer distribution
- Cable to UPS input from external batteries/external Battery Breaker Box (systems with external battery)
- Solid core, control cable to UPS from Service Bypass Panel
- Solid core, control cable to UPS from external batteries/external Battery Breaker Box

Unpacking



2.0 Unpacking

NOTICE!

Unless otherwise specified by the shipping company use a fork lift to unload equipment from pallet

1. To unpack UPS unit, remove top and bottom screws from side plates of packaging and lift up side plates
2. Verify compliance between type label on reverse side of front door and system ordered. Check input and output voltage
3. Copy type label data to label copy below for easy identification of system
4. Use fork lift to transport system to installation site

Copy of type label

		Hotline Support +353 91 70 2111 E-mail Support www.apccemea.com/service/webstars.nsf/callinfoweb?OpenForm		 						
Place label according to SKU no	SKU no	Model	Voltage	Current in/out	Weight	Battery				
			30-N-PE 50Hz	30-N-PE 60Hz		Nom. V DC	AH	Current	Backup time	Type
	SL60KH	APC SILCON 60kW 400V UPS W/TERMINALS F. EXT. BATTERIES 60kVA 60kW	380 400 415	115.6A / 90.9A 118.6A / 87A 106A / 83.3A	440 Kg	2x384	N/A	81.4	N/A	N/A
	SL80KH	APC SILCON 80kW 400V UPS W/TERMINALS F. EXT. BATTERIES 80kVA 80kW	380 400 415	153.5A / 121.2A 146.8A / 115.9A 141.7A / 111.1A	440 Kg	2x384	N/A	108.4	N/A	N/A
	SL120KH	APC SILCON 120kW 400V UPS W/TERMINALS F. EXT. BATTERIES 120kVA 120kW	380 400 415	233.4A / 181.8A 223.3A / 173.9A 214A / 166.7A	810 Kg	2x384	N/A	165.2	N/A	N/A
	SL160KH	APC SILCON 160kW 400V UPS W/TERMINALS F. EXT. BATTERIES 160kVA 160kW	380 400 415	319.3A / 242.4A 295.8A / 231.9A 283.5A / 222.2A	810 Kg	2x384	N/A	220	N/A	N/A
	SL240KH	APC SILCON 240kW 400V UPS W/TERMINALS F. EXT. BATTERIES 240kVA 240kW	380 400 415	463.9A / 363.6A 443.8A / 347.8A 425.3A / 333.3A	1460 Kg	2x384	N/A	327.6	N/A	N/A
	SL320KH	APC SILCON 320kW 400V UPS W/TERMINALS F. EXT. BATTERIES 320kVA 320kW	380 400 415	614.7A / 484.8A 588A / 463.8A 563.5A / 444.4A	1460 Kg	2x384	N/A	436.3	N/A	N/A
	SL480KH	APC SILCON 480kW 400V UPS W/TERMINALS F. EXT. BATTERIES 480kVA 480kW	380 400 415	922.1A / 727.3A 882A / 695.7A 845.2A / 666.7A	1800 Kg	2x384	N/A	657.9	N/A	N/A
TEST PERSONNEL DATE AND SIGNATURE _____										



PLEASE RECYCLE

The shipping materials for the APC Silcon UPS are recyclable. Please save them for later use or dispose of them appropriately.

3.0 Installation

3.1 Requirements on Site

All system parts are accessible from front or top of UPS. Cable entries are accessible from bottom. A 1m free space on all sides should be allowed during installation. Once the system is installed it may be placed close to walls as long as free space is allowed for system doors to open. (Per applicable national and/or local codes.)

For ventilation and service purposes allow for free space of minimum 1m above the unit or per national and/or local codes and in front of UPS. Never install systems in direct sunlight.

NOTICE!

For reliability reasons do not stand on the UPS. Keep the UPS cabinet surface free of any objects.

3.1.1 Cabinet Dimensions

UPS	Height [mm]	Width [mm]	Depth [mm]
320kW	1800	1600	800
480	1800	1900	800

Cabinet

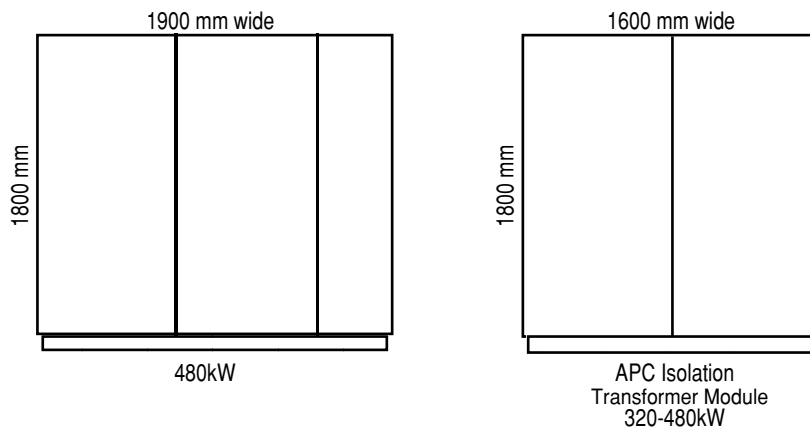

Installation

3.2 Footprint

3.2.1 1900mm Cabinet for 480kW UPS

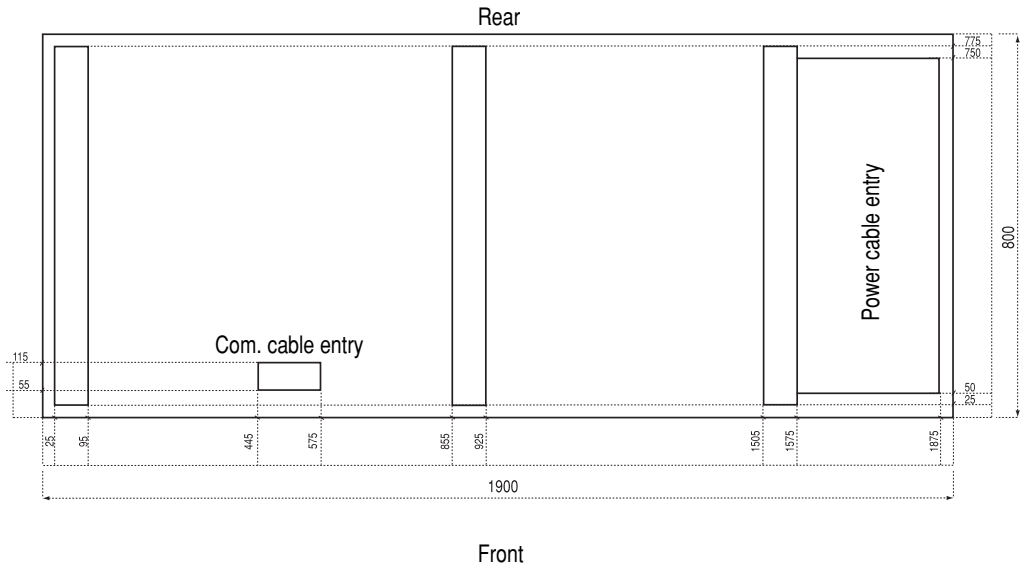

3.2.2 1600mm Cabinet for 480kW Isolation Transformer

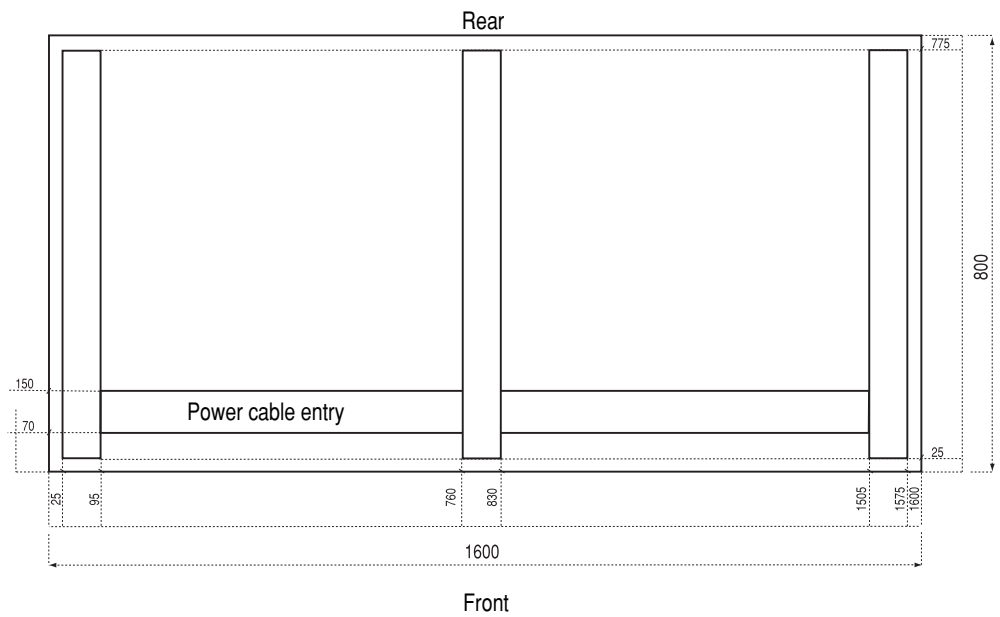

External Connection

4.0 External Connection

4.1 Connecting the UPS

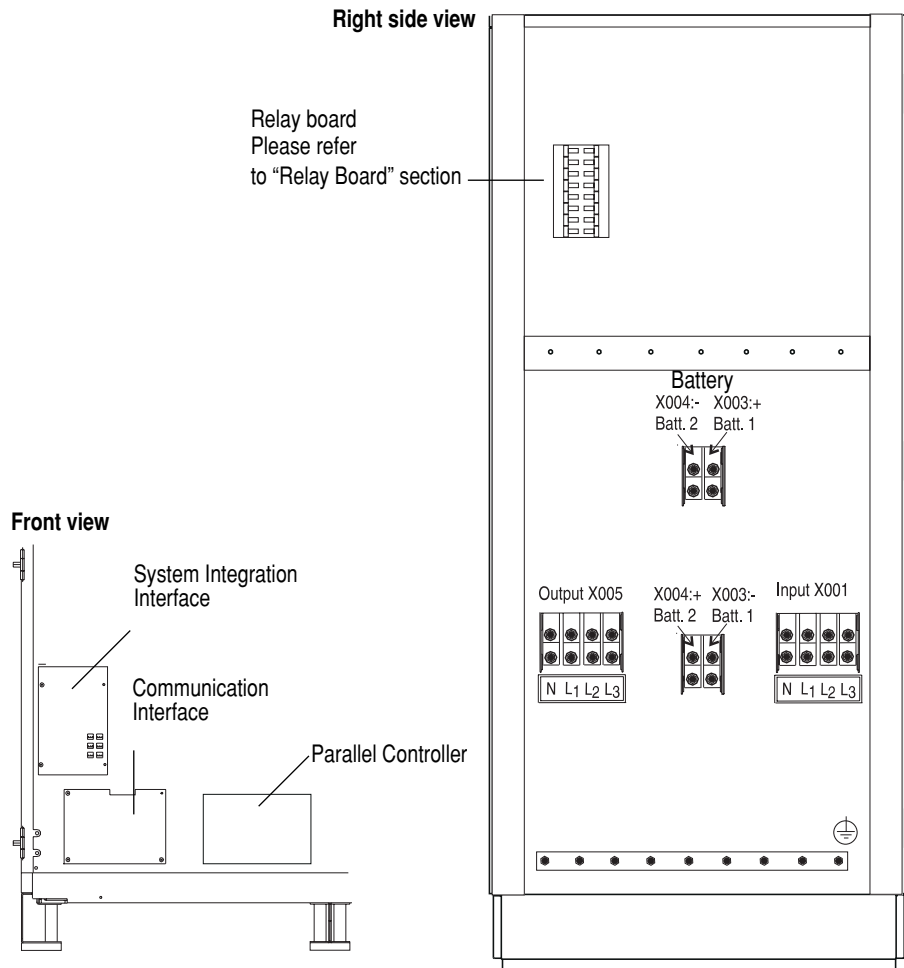

NOTICE!

Check correct phase rotation of mains input voltage!!
Max. input/output cables: 3//300 mm².
If there is no neutral input Dzn0 or Dyn11 input isolation transformer is required.



CAUTION!

This UPS unit is an EN 50091-2 product and may cause radio interference in a domestic environment. Take preventive measures in necessary.

External Connection



CAUTION!

At a switch mode load of 100% the neutral must be rated for 200% output phase current.

UPS	External Input Fuses* FM [A] 380-415V	External Input Cable [mm2] 380-415V	External PE Cable [mm2]	Maximum External Output Fuses* [A]	External Output Cable [mm2]
480kW	1000	3//185	185	800	3//150

* DIN gL types

NOTICE!

All cable dimensions are recommended sizes only. Refer to local legal regulations.

UPS	External Alarm Cable max. [mm2]	External System Earth Cable [mm2]**	External Battery Breaker [A]	External Battery Cable [mm2]
480kW	2	25	800	3//150

PVC cables insulated to withstand ambient temperature of max. 30oC

** Must be rated as external PE cable if mains system is not supplying PE

NOTICE!

Install gland plate in bottom of unit.

External Connection

4.2 System Integration Interface

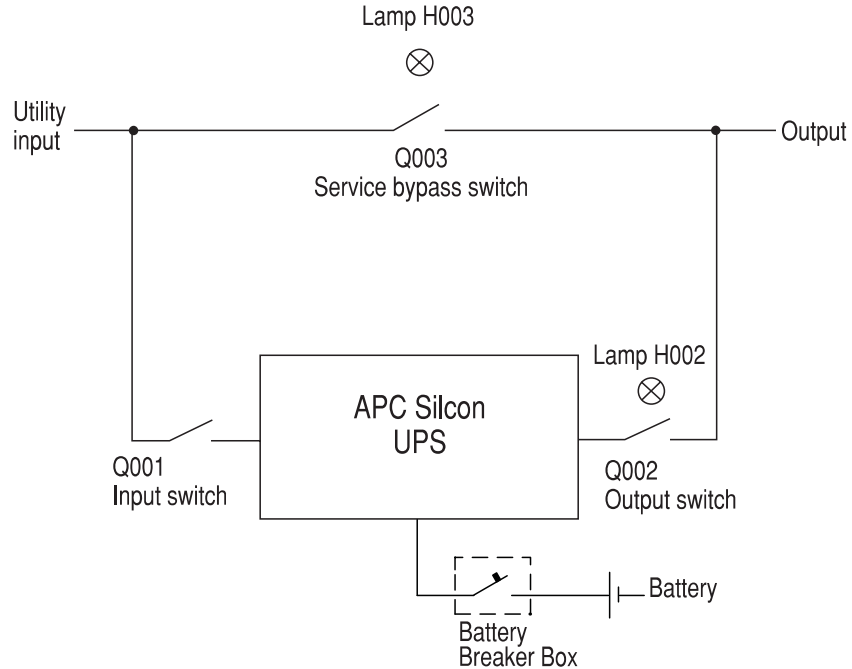

NOTICE!

Consistent use of designations (Q001, Q002, Q003, H002, H003) in diagrams simplifies information exchange.

System Integration Interface (SII) is the control link between UPS and system main switches as shown in above diagram. The purpose of the SII is to ensure correct operation of switches without losing system output power.

Auxiliary contacts on the main switches transmit the SII board inputs. Lamps on Service Bypass Panel and Battery Breaker Box/Battery Cabinet indicate “green light” for operation of output switches.

SII board also integrates input facilities for emergency shut-down and temperature compensation of charge voltage for external battery (use with battery monitor). “Battery operation” and “Common fault” are two main SII board status relay signals.

External Connection

4.2.1 Connections

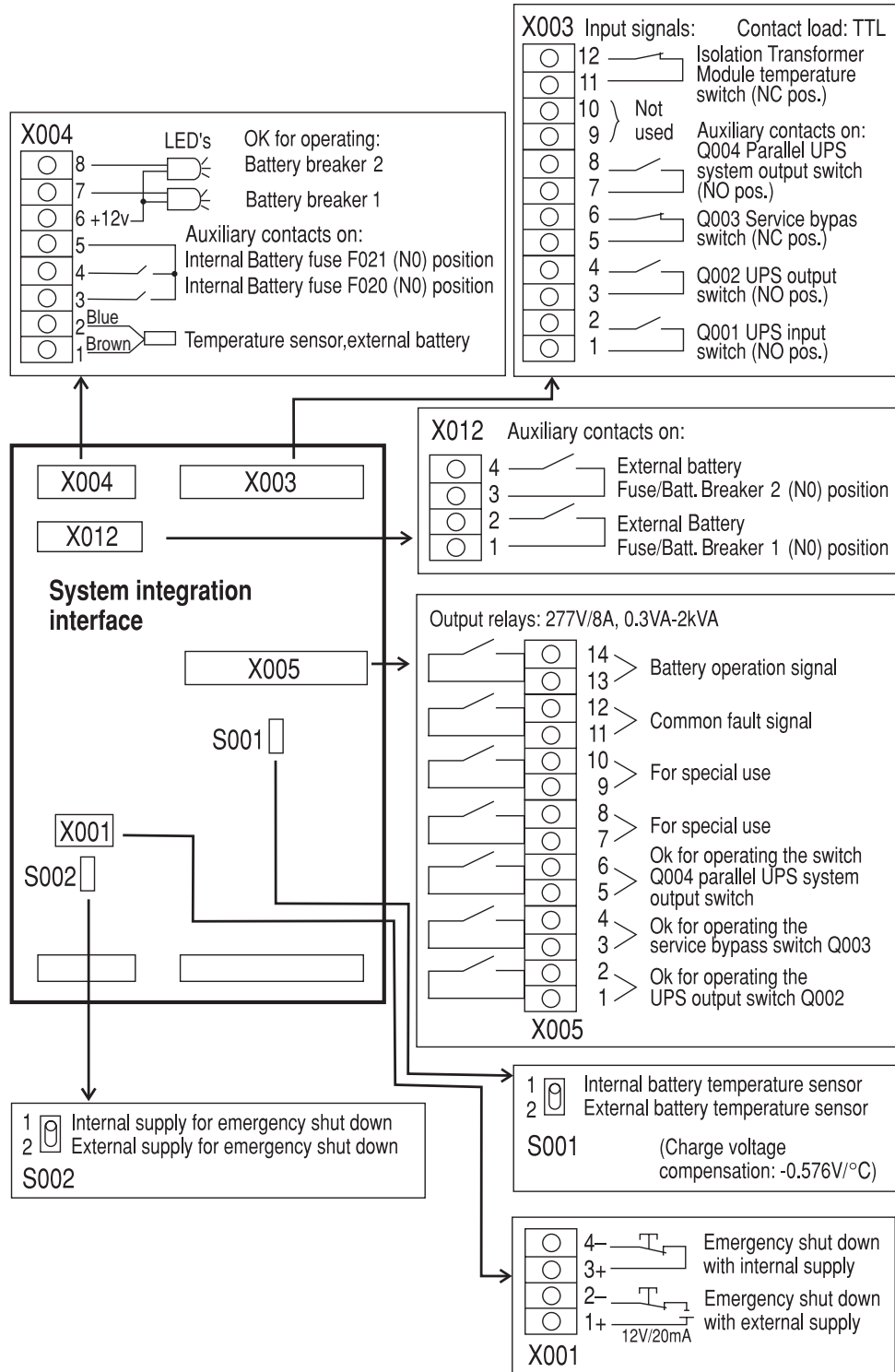

External Connection

Terminal Blocks: X003/X004 (Auxiliary Contacts)

When switching Q001, Q002, Q010, Battery Breaker 1 or Battery Breaker 2 from “ON or 1” to “OFF or 0”, the auxiliary contact has to be open BEFORE the corresponding main contacts are opened. When switching Q001, Q002, Q010, Battery Breaker 1 or Battery Breaker 2 the opposite way from “OFF or 0” to “ON or 1”, the auxiliary contact has to close with a maximum delay of 0.5 seconds from the time the corresponding main contacts are closed.

- This type of auxiliary contact is called a “late make” contact. (This also means that it will “break early” when activated in opposite direction.)
- This auxiliary contact is also called “NORMALLY OPEN” (NO), because the auxiliary contact will be open when the main contacts are open.
- Please note that the above term “NORMALLY” has nothing to do with NORMAL UPS OPERATION MODE.

When switching Q003 from “OFF or 0” to “ON or 1”, the auxiliary contact has to open BEFORE the corresponding main contacts are closed. When switching Q003 the opposite way from “ON or 1” to “OFF or 0”, the auxiliary contact has to close with a maximum delay of 0.5 seconds from the time when the corresponding main contacts are opened.

- This type of auxiliary contact is called an “early break” contact. (This also means that it will “make late” when activated in the opposite direction.)
- The auxiliary contact is also called “NORMALLY CLOSED” (NC), because the auxiliary contact will be closed when the main contacts are open.
- Please note that the above term “NORMALLY” has nothing to do with NORMAL UPS OPERATION.

X005 (Output Relays)

Battery operation signals are received with a 30-second delay. This function is inactive during battery test. Common fault relay facility is programmable (standard factory setting: 10 sec.) See APC Silcon User Guide for details.

Maximum nominal voltage on contact circuits is 277VAC. If two different phases are involved, maximum phase to neutral voltage should be below 160VAC. Please note that phase L1 is already present on the System Integration Interface board, supplied from the Service Bypass Panel. Therefore, if a phase is needed for alarm or signal purposes, Phase L1 should be used.

4.3 Parallel Board



CAUTION!

Control cables must be separated from AC and DC power cables.

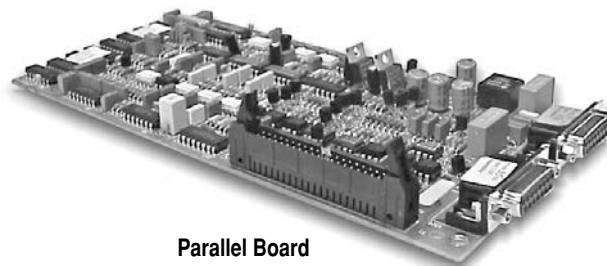

Parallel Board

990-4053

External Connection

The built-in parallel board connects two or more UPS systems in parallel, either to obtain increased system reliability or to obtain higher output power. The parallel board also ensures correct load-sharing between parallel systems.

NOTICE!

For reliability reasons, APC recommends separate battery packs in redundant/parallel configurations.

To prepare the UPS for parallel/redundant mode, disconnect all sources of AC and DC power supply to the UPS and connect the ribbon cable from the parallel board to the main controller board (the ribbon cable is delivered with the UPS).



CAUTION!

DO NOT connect ribbon cable between controller and parallel card in single configurations. Ribbon cable is for parallel operation only.

Complete the parallel system set-up by connecting the external control cables (see below). Follow the instructions in the “Programming Parameters for Advanced Parallel” section of this guide to execute necessary re-programming.

External Connection

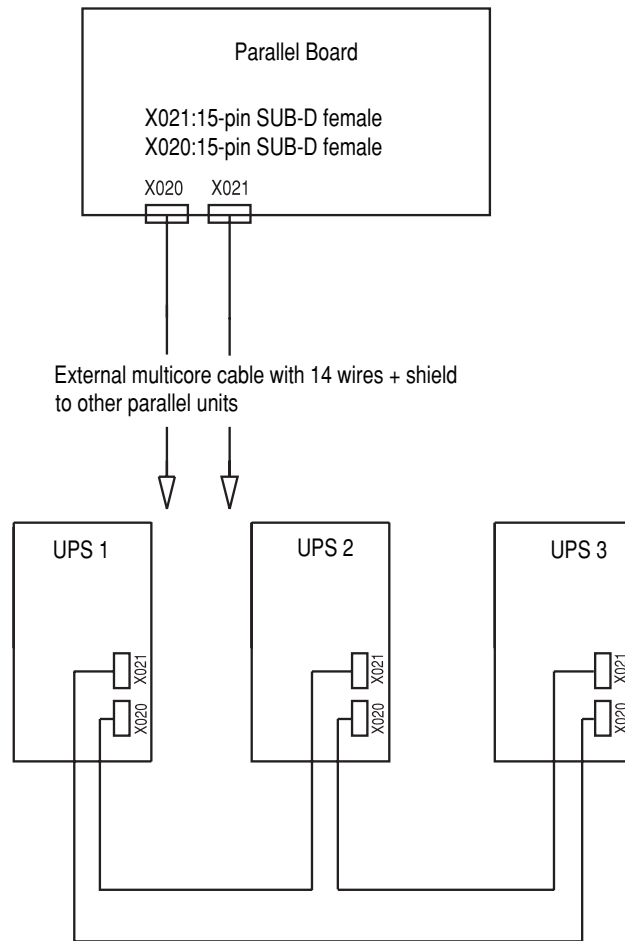

External Control Cables

External multicore cable is equipped with 15-pin SUB-D plug at either end. Connect pin 1 to pin 1, and pin 2 to pin 2 etc. up to pin 15 - with the exception of pin 8, which is not to be connected.

Shield is connected to plug cover at both ends.

Terminals X020 and X021 for control cables located on parallel board. Connect X020 in UPS1 to X021 in UPS2, and connect X020 in UPS2 to X021 in UPS3 etc. Connect X020 in last UPS to X021 in UPS1.

Cable is delivered with the UPS.

Power Cables

To optimize load-sharing in parallel operation, external power circuits must be "symmetrical": Power input and output cables to have same length and identical cross-sections.

External Connection

4.4 Relay Board

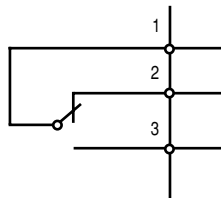
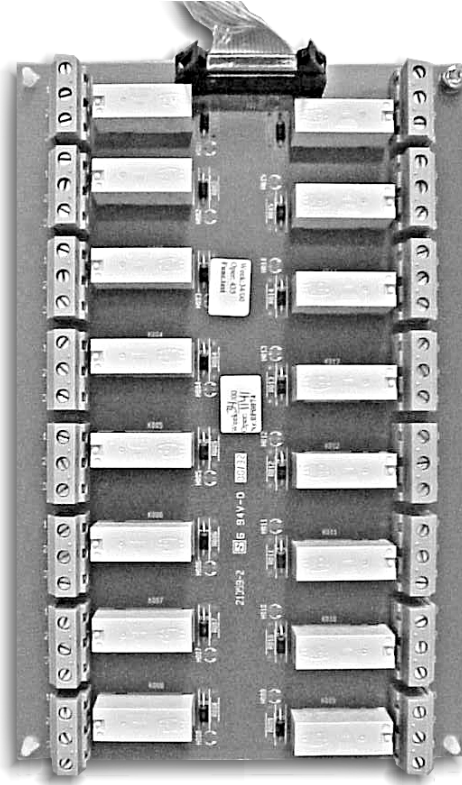
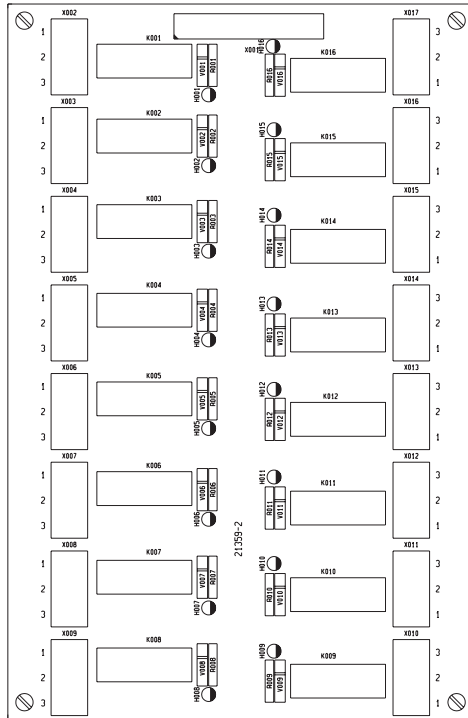

Maximum load: 8.0A – 250VAC
0.3A – 60VDC

Minimum load: 0.05A – 6VAC
0.05A – 6VDC

Relays

All relays are “fail safe”: In alarm modes, relay coil will be de-energized.

External Connection

4.4.1 Relay Board/Relay Functions

NOTICE

If alarm mode "Communication to controller lost" is active, ALL relays will indicate failure

Relay Number	Message	Alarm-triggering Events
1 ## (X002)	Mains outside limits	Mains voltage RMS outside limits Mains wave form (fast detector) outside limits Mains frequency outside limits
2 ## (X003)	Bypass outside limits	Bypass voltage RMS outside limits Bypass wave form (fast detector) outside limits Bypass frequency outside limits
3 ## (X004)	Output outside limits	Output voltage RMS value outside limits Output wave form (fast detector) outside limits Output frequency outside limits
4 (X005)	System overload	Output load exceeding 100% Delta inverter current limiter active Main inverter current limiter active
5 (X006)	Fan fault	Blocked or faulty fan
6 (X007)	High Equipment Temperature or Inverter Fuse Blown	Static switch temperature too high Main inverter failure (temperature too high or fuse blown) Delta inverter temperature too high Magnetic temperature too high Isolation transformer (option) temperature too high Battery temperature too high
7 (X008)	MCCB battery off	Battery MCCB/Fuse not closed or released
8 (X009)	Normal operation	UPS running in normal operation mode(status)
9 ## (X010)	Battery operation	UPS running in battery operation mode(status)
10 ## (X011)	Bypass operation	UPS running in bypass operation mode(status)
11 ## (X012)	Stand-by operation	UPS in stand-by mode (Hot stand-by - parallel systems only)
12 (X013)	Service bypass operation	Service bypass switch active
13 ## (X014)	Boost charge operation	UPS boost-charging on battery
14 (X015)	Battery voltage outside limits	DC voltage too high (shut down) DC voltage below warning level DC voltage too low (shut down)
15 (X016)	Battery condition fault	ABM has detected weak battery condition ABM has detected defect battery (ABM = Advanced Battery Monitor)
16 ## (X017)	Common fault	All alarms as mentioned above (except relays 8+9+10+11) Internal power supply fault System locked in operation mode Internal memory fault Internal communication fault

990-4053

External Connection

Delay programmable in configuration stack : "Common fault delay". Settings 0,10,20,30 seconds.

See section 5.2: System configuration

NOTICE!

Alarm Triggering Events 1-2-3-9-10-11-13 activates the corresponding alarm relay after the delay.

Alarm Triggering Events 4-5-6-7-8-12-14-15 activates the corresponding alarm relay momentarily.

Common fault relay 16 is activated at the same time as relay 1-2-3-4-5-6-7-12-13-14-15, or in any of the below situations.:

- Internal power supply fault
- System locked in operation mode
- Internal memory fault
- Internal communication fault

External Connection

4.5 Communication Interface Board

The 3-port ComInterface is used to establish an interaction between UPS and e.g. a computer system. Main purpose: To ensure a controlled computer shut-down in case of a mains supply failure.

4.5.1 Connections

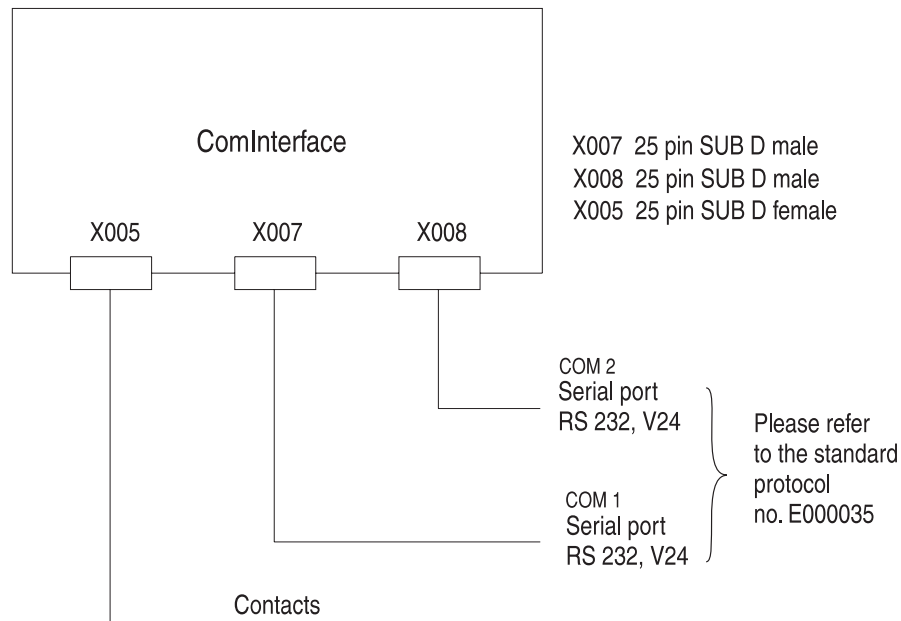

Contacts between:	UPS status:
14 15 2	2-14 The UPS is OFF, no output voltage 2-15 The UPS is ON, output voltage present
16 17 4	4-16 The UPS is not in bypass operation 4-17 The UPS is in bypass operation
18 19 6	6-18 The UPS is not in battery operation 6-19 The UPS is in battery operation
20 21 8	8-20 The UPS battery voltage is above the warning level 8-21 The UPS battery has been discharged to the warning level (Low battery) Please refer to the Programming section for programming of the warning level
13 + 25 -	Input for remote shutdown of the UPS Signal required: 3,5-25V pulse for min. 1 sec.
Relay contacts rating:	Max 42VAC or 60VDC min. 0.05A, max. 0.5A

External Connection

4.6 Connecting of APC Silcon Tripel Chassis

The enclosed Triple Chassis must be connected to the serial port on the Communication Interface Board, and to the 24V supply (cables included). Terminal locations shown below.

480

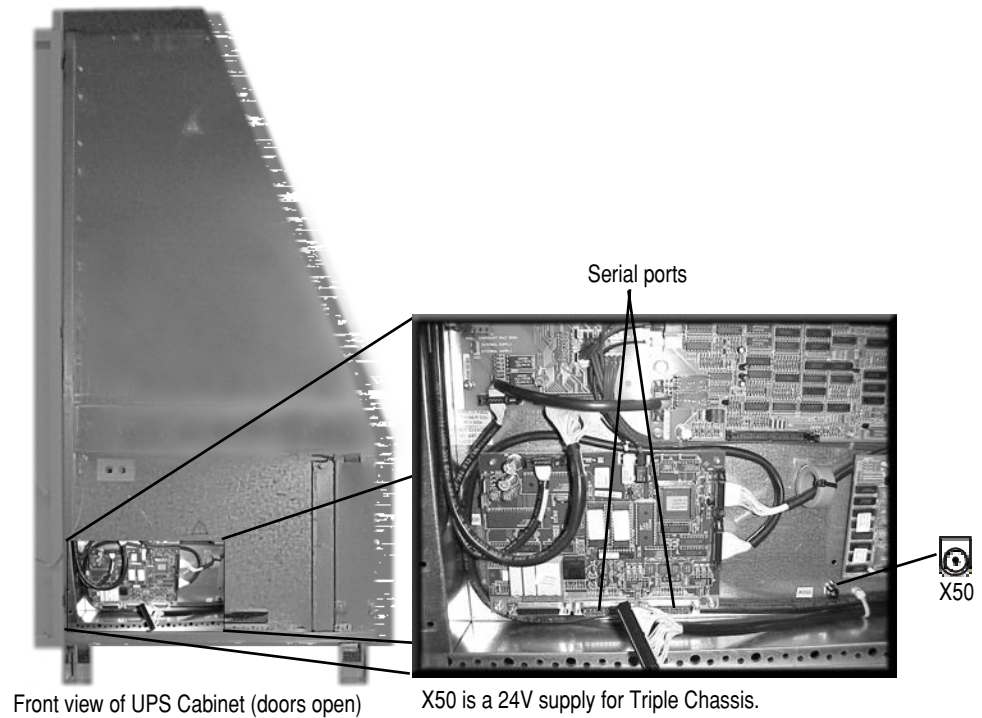

Front view of UPS Cabinet (doors open)

X50 is a 24V supply for Triple Chassis.

Only to be used for this purpose.

Not suitable for telephone equipment.

Triple Chassis must be connected to both X50 and a serial port.

APC Silcon Triple Chassis



For more information please refer to the following section.

990-4053

4.7 APC Silcon Triple Chassis

The APC Silcon Triple Chassis (AP9604S) is an American Power Conversion (APC) external management peripheral that allows you to use monitoring and control management peripherals with your APC Silcon series UPS. The retrofit model (AP9604SR) is for use with Silcon series UPSs that are not equipped with a 24 VDC power port.

4.7.1 Safety Warnings

Use the APC Silcon Triple Chassis only in conjunction with an APC Silcon UPS.

Do not connect a computer to any APC Silcon Triple Chassis port using a straight-through extension cable. Use the communications cable provided with the APC Silcon Triple Chassis.

Connections using a cable made by any other manufacturer may cause damage or improper operation of the APC Silcon Triple Chassis, the UPS, or the computer.

4.7.2 Product Description

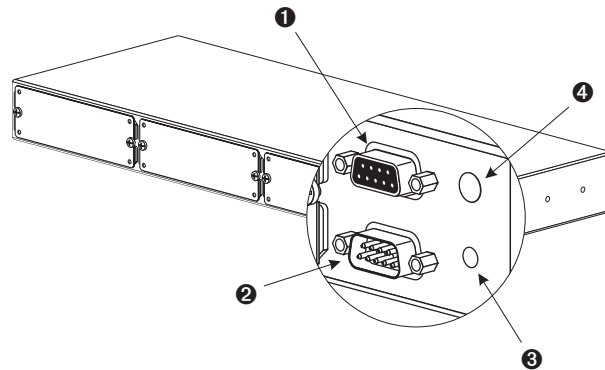

- | | |
|-------------------|-----------------------|
| 1 Monitoring port | 3 Status LED |
| 2 To UPS port | 4 Optional Power port |

4.7.2.1 Monitoring Port

The Monitoring port has two functions:

- Connecting to a terminal for configuration of the chassis. For direct connection to the Monitoring port, you must use the Monitoring cable supplied with the chassis (APC P/N 940-0024C).
- Connecting to other APC external management peripherals in a daisy chain.

4.7.2.2 To UPS Port

The “To UPS” port connects the chassis to the UPS, using the Silcon UPS cable (APC P/N 940-0071). The cable connector plugs into a communications port on an APC Silcon UPS.

External Connection

4.7.2.3 LEDs

The APC Silcon Triple Chassis status LED provides important information concerning operation of the chassis. Refer to the table below for a description of the conditions indicated by the LED.

IF the LED is...	THEN the Silcon Triple Chassis...
off	is not receiving power.
flashing quickly (5 times per second)	has not been configured. See the APC Silcon Management Quick Start Guide provided with your chassis or the Web/SNMP Management Card Installation Guide on the CD for more information.
flashing slowly (1 time per second)	is powered on but is not communicating with the UPS.
on	is operating normally.

4.7.2.4 Optional Power Input

With the Optional Power input, you can power the APC Silcon Triple Chassis from an external source, using a 24 VDC power adapter. A universal adapter (AP9505i) or a standard adapter (AP9505) can be purchased separately from APC.

4.7.3 Installing Management Peripherals

There are two basic types of APC management peripherals that work with the APC Silcon Triple Chassis:

- Management peripheral cards, which fit into external management peripherals that are equipped with a card slot.
- External management peripherals, which connect to the Monitoring (or Advanced) port of other external management peripherals.

NOTICE!

The name "Monitoring" port varies from product to product, but its purpose is the same – to replicate the UPS communications port.

External Connection

4.7.3.1 Order of Management Peripheral Cards

Because UPS signals are passed between management peripherals, you must install management peripheral cards in the correct order for them to work together properly. The card slots are numbered 1 to 3, from left to right, as viewed from the rear of the chassis. The following table lists the management peripheral cards, their priority, and proper position.

Management Peripheral Card	P/N	Priority	Position
Web/SNMP Management Card	AP9606	Highest	High-numbered slot  Low-numbered slot
Out-of-Band Management Card (Call-UPS® II)	AP9608	Second-highest	
Interface Expander	AP9607	Second lowest	
Environmental Monitoring Card (Measure-UPS® II)	AP9612T AP9612TH	Lowest	

4.7.3.2 Installing Management Peripheral Cards

To install management peripherals, perform the following steps.

- 1) Make sure that the chassis is powered off.
- 2) Install management peripheral cards into the housings on the rear of the chassis. See the instructions supplied with the cards and the table above.
- 3) If you are daisy-chaining other APC external management peripherals to the APC Silcon Triple Chassis: Connect the UPS cable (supplied with the management peripheral) to the Monitoring port of the chassis and to the “To UPS” port of the other management peripheral (Share-UPS, MasterSwitch, etc.). See “Daisy-chaining the APC Silcon Triple Chassis”.
- 4) Power the APC Silcon Triple Chassis and all external management peripherals.

NOTICE!

If your configuration requires additional power, connect a 24V AC/DC power adapter available from APC (part number AP9505 or AP9505i) for all models of Triple Chassis.

4.7.3.3 Daisy-chaining the APC Silcon Triple Chassis

If you need more than the three card slots available with the APC Silcon Triple Chassis, or if you want to use other external management peripherals, you can daisy-chain external management peripherals together, provided that the total amperage of all installed management peripherals — cards and external — does not exceed the supplied amperage. (See “Determining Power Requirements:”).

NOTICE!

When daisy-chaining Triple Chassis units, you may need to use a power adapter.

External Connection

To add card slots, you can daisy-chain the APC Silcon Triple Chassis with the standard Triple Chassis (AP9604) management peripheral, installing the APC Silcon Triple Chassis closer to the UPS.

4.7.4 Powering the APC Silcon Triple Chassis

The APC Silcon Triple Chassis supplies power to the installed management peripheral cards and to the Monitoring port, allowing you to power multiple management peripherals.

4.7.4.1 AP9604S Power Considerations

The AP9604S model of the APC Silcon Triple Chassis receives its power from the UPS through the power connector of the Silcon UPS cable. If the total current required by all the installed management peripherals exceeds 500 mA, you must use a 24 VDC power adapter. To find out whether you need additional power, see “Determining power requirements”.

4.7.4.2 Power Adapters

APC offers two models of 24 VDC power adapter.

- The standard adapter (AP9505) can provide an additional 400 mA.
- The universal adapter (AP9505i) can provide 850 mA.

4.7.4.3 Using a Power Adapter

To use the adapter, plug it into a protected power outlet and into the Optional Power port of the APC Silcon Triple Chassis.

NOTICE!

If the power adapter loses power because of a UPS shutdown, its attached management peripherals may not operate properly, thus adversely affecting the UPS and its protected equipment.

4.7.4.4 AP9604SR Power Considerations

The AP9604SR model receives its power from the UPS through the supplied 24 VDC universal adapter. The total current required by your management peripherals must not exceed the 850 mA limit of the power adapter. See “Determining power requirements”.

4.7.4.5 Determining Power Requirements:

To determine the total amount of current required by your management peripherals, add the individual current requirements for each management peripheral to be installed with the APC Silcon Triple Chassis to the current requirements of the chassis itself. Refer to this table

Part #	Management Peripheral	Draw (mA)
AP9207	Share-UPS 8-port Interface Expander	65
AP9600	Expansion Chassis	30
AP9604	Triple Chassis	20

External Connection

AP9604S[R]	APC Silcon Triple Chassis	90
AP9606	Web/SNMP Management Card	110
AP9607	Interface Expander	45
AP9608	Out-of-Band Management Card (Call-UPS II)	35
AP9612	Environmental Monitoring Card (Measure-UPSII)	60
AP9825i	Isolated Extension Cable	50
AP9830	Remote Power-Off Device	35

4.7.5 Troubleshooting

The following table shows the solution to common problems with the operation of the Triple Chassis

Problem	Possible Cause	Solution
Status LED is off	The chassis is not receiving adequate power.	See “Powering the APC Silcon Triple Chassis”, and verify that you are not exceeding current requirements.
Status LED is flashing quickly	The chassis has not been configured.	Configure the Silcon Triple Chassis. See the APC Silcon Management Quick Start Guide provided with your chassis or the Web/SNMP Management Card Installation Guide on the CD for more information.
Status LED is flashing slowly	The chassis is not communicating with the UPS.	Verify that the supplied UPS cable is properly connected to the Triple Chassis and to a communications port on the UPS.
Attached management peripheral cannot identify UPS model or nominal output voltage.	The management peripheral firmware does not support 3-phase UPSs.	You may be able to upgrade the firmware of the management peripheral. Call APC Customer Support.

4.7.5.1 If Problems Persist

For problems not covered in the troubleshooting chart or for persistent problems, follow this procedure:

- 1) Note the serial number and date of purchase of the APC Silcon Triple Chassis. Contact APC Customer Support at the phone number or address that is listed in this manual.
- 2) Be prepared to provide a description of the problem. A technician will help solve the problem over the phone, if possible, or will give you a return material authorization (RMA) number.
- 3) If the APC Silcon Triple Chassis is under warranty, repairs are free of charge. If the warranty has expired, there will be a nominal charge for repair.

990-4053

External Connection

- 4) Pack the APC Silcon Triple Chassis carefully in its original packaging, if possible. Do not use polystyrene beads for packing. Damage sustained in transit is not covered under the warranty. Enclose a letter in the package with your name, address, RMA number, a copy of the sales receipt, daytime phone number, and payment (if applicable).
- 5) Mark the RMA number clearly on the outside of the shipping carton. The factory will not accept any materials without this marking.
- 6) Return the Triple Chassis by insured, prepaid carrier to the address given to you by APC Customer Support.

4.7.6 Product Specifications

4.7.6.1 Monitoring Port Pin Assignments

The Monitoring port is a 9-pin communications port. The port operates with no flow control at a rate of 2400 baud. The data format is 8 data bits with 1 start bit, 1 stop bit, and no parity. When the Triple Chassis operates with simple signalling, the following limitations and capabilities apply to the Monitoring port:

- Pins 3, 5, and 6 are open collector outputs which must be pulled up to a common referenced supply no greater than +40 VDC. The transistors are capable of a non-inductive load of 25 mA. Use only Pin 4 as the common.
- The output at Pin 2 generates a low-to-high RS-232 level when the device is signalling an On Battery condition. The pin is normally at a low RS-232 level.
- The UPS is signalled to shut down when a high RS-232 level is applied to Pin 1 for 4.5 seconds. Shutdown is also dependent on the UPS status.

When the Triple Chassis operates with advanced signalling, the following limitations and capabilities apply to the Monitoring port:

- Pin 7 is unassigned.
- DC operating voltage is available on Pin 8. This voltage may be from the UPS or from an external adapter, whichever is greater.

External Connection

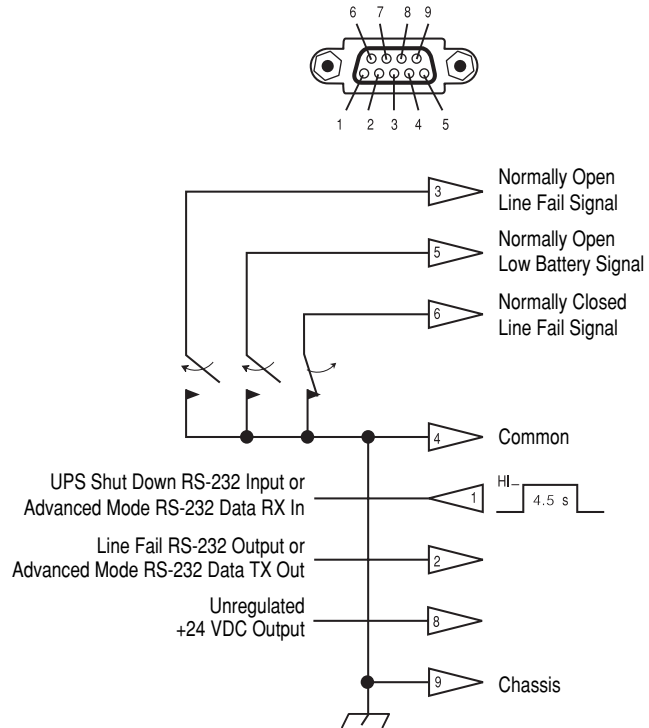

External Connection

4.7.6.2 Power, Physical, and Environmental Specifications.

Item	Specification
Power	
Turn on voltage:	> 22 VDC
Turn off voltage:	< 16 VDC
Current draw (normal operation):	90 mADC
Current draw (voltage < 16 VDC):	< 1 mADC
Physical	
Size (H xW x D):	1.75 x 17.0 x 5.0 in (44 x 432 x 127 mm)
Weight:	4.02 lb (1.81 kg)
Shipping weight:	8.12 lb (3.65 kg)
Environmental	
Elevation (above MSL):	
Operating Storage	0 to 10,000 ft (0 to 3000 m) 0 to 50,000 ft (0 to 15 000 m)
Temperature:	
Operating Storage	32 to 113°F (0 to 45°C) -4 to 158°F (-20 to 70°C)
Relative humidity:	
Operating Storage	0 to 95%, non-condensing 0 to 95%, non-condensing
Electromagnetic immunity:	FCC Class A EN50082-1 verified

4.8 APC Silcon Battery Cabinets

IMPORTANT SAFETY INSTRUCTIONS

- a The installation of battery drawers in UPS cabinets requires battery knowledge and should be made or supervised by qualified personnel only. Keep unauthorized personnel away from batteries.
- b Use identical battery types and numbers when replacing batteries. See battery supplier manual for further details.
- c **CAUTION** - Do not dispose of batteries in a fire. Battery may explode.
- d **CAUTION** - Batteries are fully charged on delivery. Do not short battery terminals or DC terminals.
- e **CAUTION** - Avoid rough treatment and opening of batteries. Released electrolyte is harmful to skin and eyes and may be toxic.
- f **CAUTION** - Batteries may cause electric shocks and high voltage short-circuit current. Follow below precautions when working with batteries:
 - 1 Remove watches, rings and other metal objects.
 - 2 Use tools with insulated handles.
 - 3 Wear rubber gloves and boots.
 - 4 Do not leave tools or metal parts on top of batteries.
 - 5 Disconnect charging source prior to connecting batteries.

Installation and use of this product must comply with all national, federal, state, municipal or local codes. If you need assistance, please have your UPS model and serial number ready and call APC, see **“How to Contact APC”** in this guide.

For more information on the APC World Wide Web site at <http://www.apc.com>.



WARNING!

The entire system contains HAZARDOUS AC/DC VOLTAGES from several power sources. Some terminals and components are live even with the system being switched off!

ONLY qualified electricians should carry out installations according to national and local codes.

NO UPS types may have built-in batteries when connected to external batteries!

NEVER install batteries not complying with APC specifications. Failing that, the installer takes over full responsibility!

NEVER lift or transport connected or installed batteries.

NOTICE!

For reliability reasons do not stand on the UPS. Keep the UPS cabinet surface free of any objects.

External Connection

4.8.0.6 Installation of Batteries

See Installation Guide for Battery Cabinet for:

- Preparing Batteries and UPS
- Dimensions and Weight
- Connecting Batteries



WARNING!

Before proceeding, ensure that power supplies have been disconnected from UPS for a minimum of 5 minutes.



CAUTION!

Follow "Start-up Procedure" in APC Silcon User Guide.

Diagram - UPS with Battery Cabinet

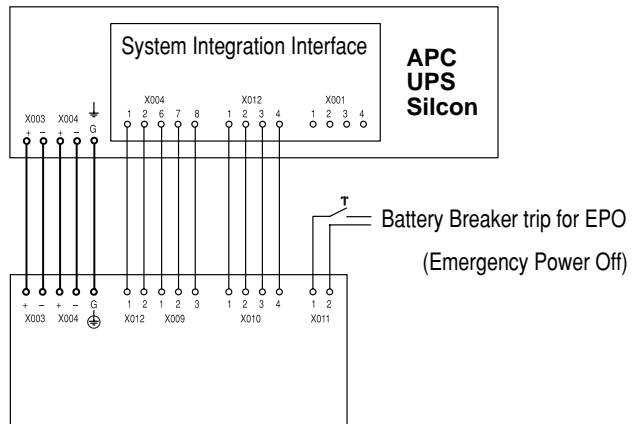

External Connection

4.9 Battery Breaker Box/Fuse-box



CAUTION!

Batteries connected to a UPS out of service for a period exceeding 8 days may be damaged. Refer to Section 7.0 Power Disconnection in this guide.

Battery Breaker Box/Fuse-box provides overcurrent and short-circuit protection for UPS installations with external batteries.

NOTICE!

If battery has been disconnected, refer to Section: - UPS Start Up in the APC Silcon User Guide.

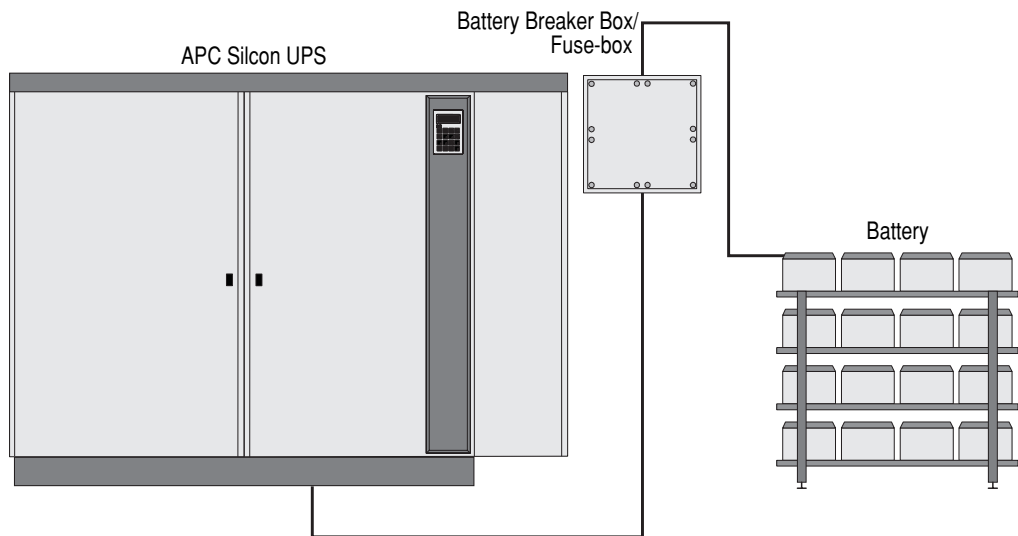

External Connection

4.9.1 Battery Breaker Box

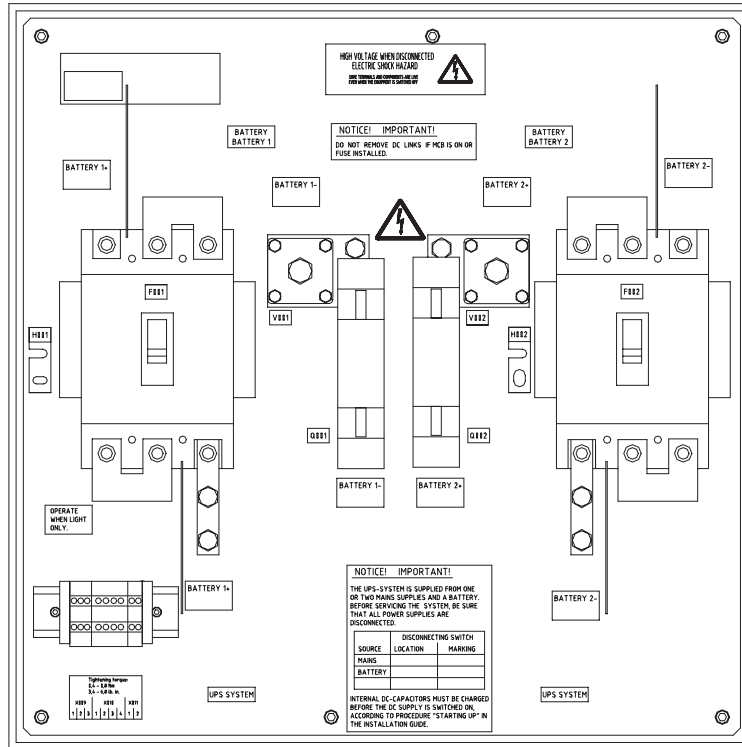

UPS	Ampere Rating [A]	Connection Cable [mm ²]	Max. short-circuit current [kA]	Dimensions HxWxD [mm]	Weight [kg]
480kW	800	3//150	40	1035x835x300	100

External Connection

4.9.2 APC Battery Breaker Box Connection Diagram

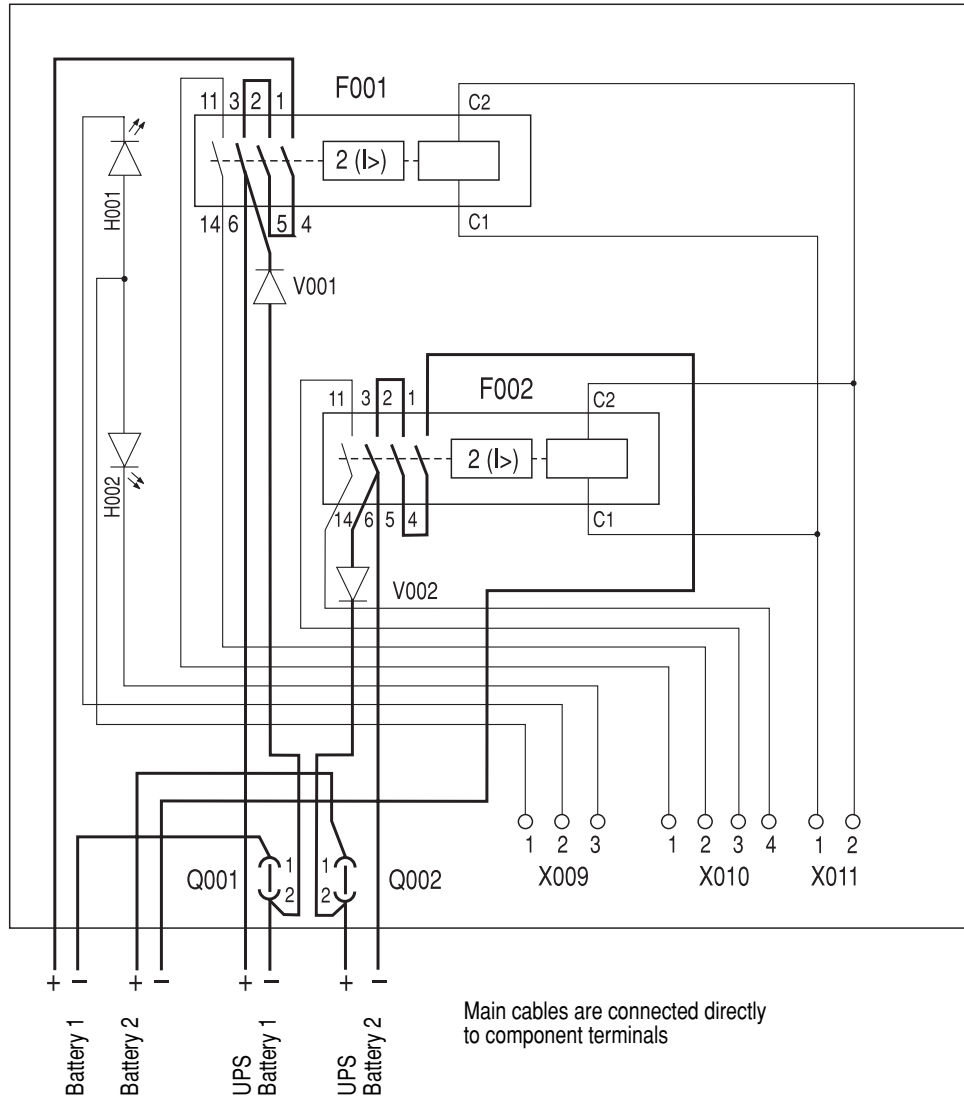

- X009 LED signal from UPS "OK to operate corresponding MCCB"
- X010 MCCB position signals for UPS
- X011 Trip for emergency stop (220-240V AC)

External Connection

4.9.3 UPS with External Battery in Battery Breaker Box/Fuse-box Configuration

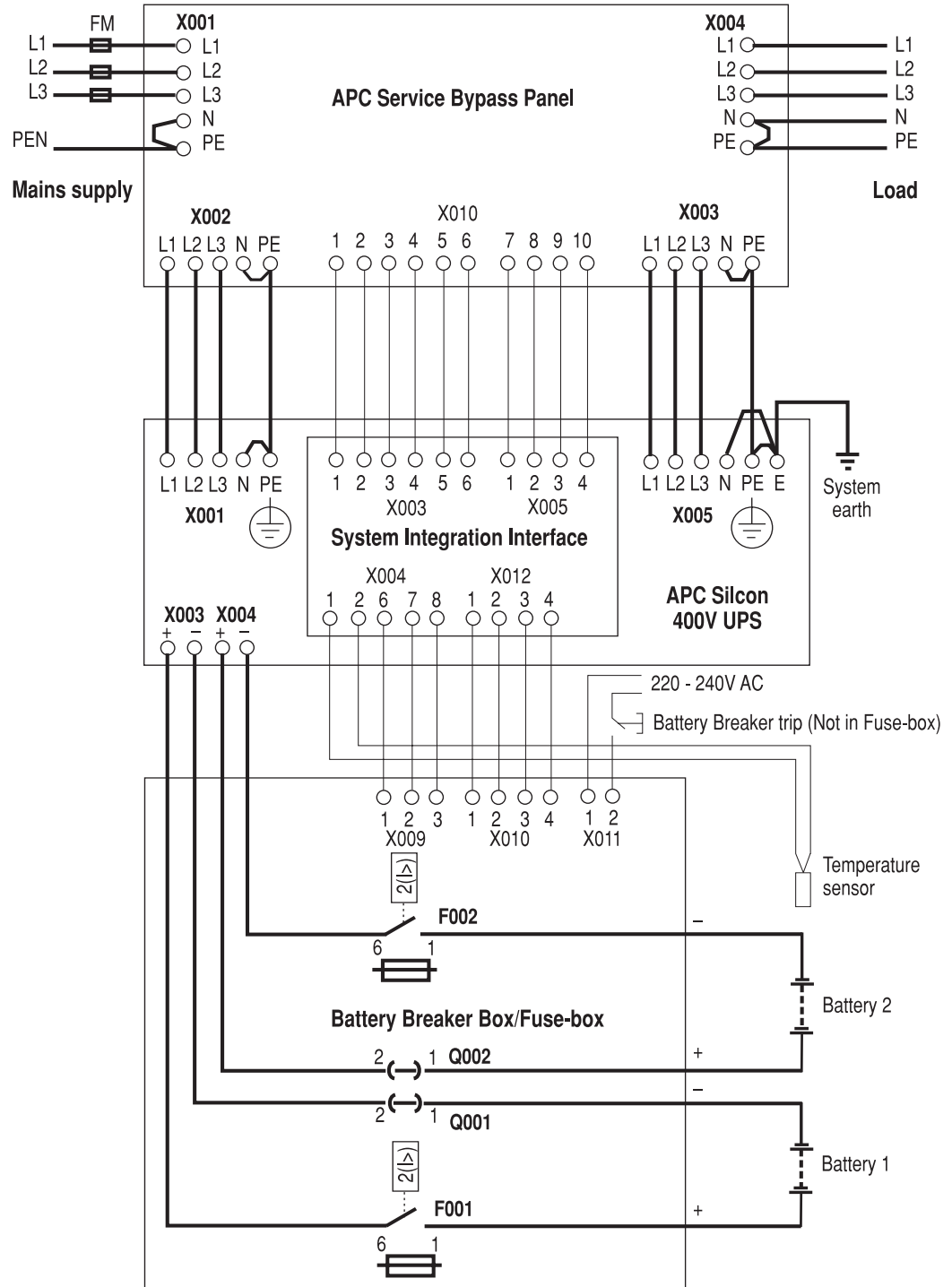

Programming Parameters

5.0 Programming Parameters

Below table shows operating parameters programmable from keyboard. Only qualified users should re-set programming parameters.

5.1 Parameters

Parameter	Setting*	Comments
Bypass operation	YES, NO	YES will switch the system into bypass mode
Language	GB , D, F DK, S, SF NL, PL, CZ E, P, SK, H	Language of text in display
Autostart	YES, NO	Automatic restart by mains return (1 min.delay). Ensures quick battery recharge
Remote shutdown active	YES, NO	Shutdown of UPS by remote signal when in battery operation. Saves battery energy
Remote shutdown	HIGH , LOW	Nature of remote shutdown signal level
Remote shutdown time	0, 1, 2 , 3, 4 5, 6, 7, 8, 9 10 min.	Time delay on remote shutdown of UPS
Battery capacity test	---	Initiates back-up time check. Time measured from start until it reaches low DC warning level. (See User Guide section 6)
Battery monitor test**	---	Initiates checks of battery condition by 25% discharging
Automatic battery test**	OFF , 3, 6 months	Activates the battery monitor test in cyclic intervals
Battery monitor reset**	---	Press the C and □ key to resets alarm (flashing light)!
Boost charge	YES, NO	YES results in boost charge (10 hours)
Autoboost charge	YES, NO	YES results in boost charge after battery operation. (10 hours)
Enter new date	YYMMDD	Set to local date
Enter new time	HHMMSS	Set to local time (24 hour clock)

* Factory settings in bold

** Only for systems with Battery Monitor active

*** Do not leave system running in bypass mode (Static bypass) for extended periods of time, as batteries are not recharged in bypass mode.

Programming Parameters

5.1.1 Programming Keys

NOTICE!
Display accuracy is + 1%, + digit.

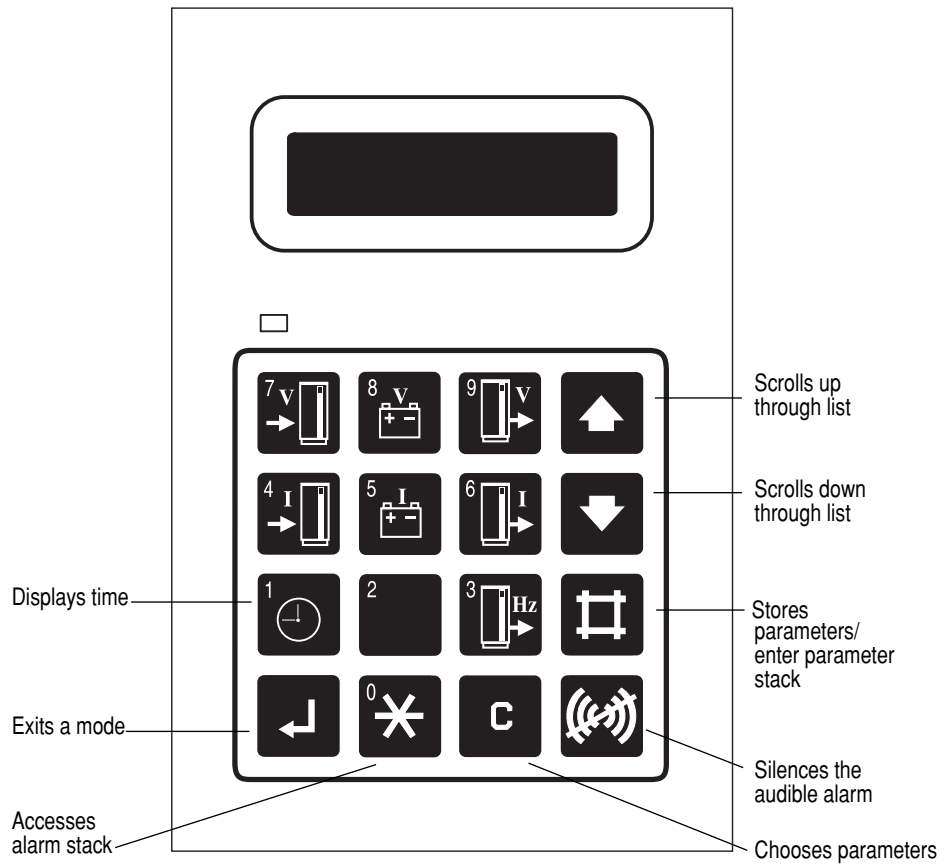







Programming Parameters





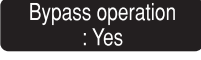

5.1.2 Programming Example - Switch to Bypass Operation

NOTICE!

Do not leave in by-pass mode for extended periods in order not to affect battery capacity.

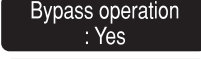
Action	Display shows
1. Press  to enter parameter stack	
2. Press  or  until	
3. Press  untill	
4. Press  to store	

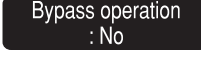
Return to normal operation

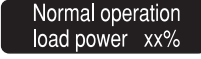
Action	Display shows
5. Press  to enter parameter stack	
6. Press  or  until	
7. Press  untill	
8. Press  to store	
9. Press  to exit	

Follow same procedure to program other parameters.

5.2 System Configuration

System configuration parameters are vital for correct system operation and are password-protected.



CAUTION!

Incorrect programming may damage battery or cause output voltage to be lost during operation!

Programming Parameters

System Configuration Parameters (password protected)















Parameter	Setting*	Comments
Isolation Transformer Input	YES, NO	YES if optional input isolation transformer is available
Isolation Transformer Output	YES, NO	YES if optional output isolation transformer is available
Delta Soft Start Time	1, 10 , 20, 40 sec.	Input current switching in ramp function. Use higher values for smaller/unstable diesel generators
External SSW present	YES, NO	YES for systems with external static bypass switch
Normal Charge Voltage	410-460V 438V	Setting of float charge voltage at 20°C (Automatic compensation for temperature deviations)
Boost Charge Voltage	438-460V 438V	Setting of boost charge voltage at 20°C (Automatic compensation for temperature deviations)
Low Battery warning	336-384V 336V	Discharged Battery warning
Low Battery shut-down	310-336V 326V	Switches off system at min. permissible battery voltage
Synchronization	0.25, 0.5, 1 , 2, 4 Hz/sec.	Synchronization speed.
High Battery Temperature	15-40°C 35°C	Alarm - Ambient temperature for battery too high
Common fault delay	0, 10 , 20, 30 sec.	Delay before common fault alarm relay is activated
Reset operation mode lock	YES, NO	YES resets system locked in bypass or battery operation mode caused by system failures (only applicable for service personnel)
Expected back-up time (min.)	0.1-999.9 5.0	Expected UPS back-up time in minutes when running at 100% ohmic load. Time used by ABM**
Battery Capacity in (Ah)	0.1-999.9 7.0	Total Battery capacity in Ah. Setting used by ABM**.
Highest Station Address	2-9	Highest station address in parallel system
Station Address	1-9	Station address in parallel system
APM Mode Active (Advanced Power Management)	Disabled Redundant +1 Parallel +1	Use only in parallel systems. Disabled: Advanced power management off. Redundant +1: Redundant operation with one unit being inactive in parallel system Parallel +1: Redundant operation with all units in operation.
APM Test Mode Active	YES, NO	YES, if APM test mode is active
Battery Connection	Common, Separate	Common: if common battery is used in parallel system. Separate: if separate battery is used

* Bold text refers to factory standard setting

**Advanced Battery Monitor

Programming Parameters

5.2.1 Programming Example - Change Charge Voltage to 446













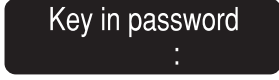

Action	Display shows
1. Press  and  simultaneously to prepare for password entry	Key in password :
2. Enter pass word xx xx xx by pressing      	Last selected parameter
3. Press  or  until message appears:	Boost charge voltage : 438
4. Press   	Boost charge voltage : 446
5. Press  to store	Data stored
6. Wait about 1 second	Boost charge voltage : 446
7. Press  to exit	Normal operation load power XX%

NOTICE!

Change charge voltages, battery warning limit, shut down voltage and high battery temperature limit by entering the actual value. See example above.

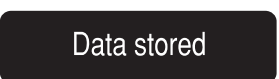
Programming Parameters

5.2.2 Programming Example - Change to Output Isolation Transformer available

Action	Display shows
1. Press  and  simultaneously to prepare for password entry	
2. Enter pass word xx xx xx by pressing 	
3. Press  or  until message appears:	
4. Press  to change	
5. Press  to store	
6. Wait about 1 second	
7. Press  to exit	

NOTICE!
Change parameters by pressing the  key once or several times. See example above.

Programming Parameters

5.3 Programming Parameters for Advanced Parallel Operation

To use the advanced parallel functions, the following parameters must be programmed:

1. "Station number"
2. "Highest station address"
3. "Advanced power management"
4. "APM test mode active"
5. "Battery connection"

5.3.1 Description of Settings

1. "Station number"
 - Valid station numbers: 1-9 stating the UPS parallel address in system.
2. "Highest station number"
 - Valid station numbers: 2-9 stating the number of UPSs in system.
3. "Advanced power management"
 - "Disabled": Advanced Power Management is inactive.
 - "PARALLEL+1": Advanced Power Management is activated when the system operates as PARALLEL N+1, meaning that one system can be isolated without overloading the remaining systems (N systems/UPSs).
 - "REDUNDANT+1": Advanced power management is activated when the system operates as REDUNDANT N+1, meaning that one system can be isolated without overloading the remaining systems (N systems/UPSs) with one spare system.
4. "APM test mode active"
 - "No": Stand-by-time will be 24 hours - on-line time will be 48 hours (xN systems).
 - "Yes": Stand-by-time will be 1 min. - on-line time will be 2 min (xN systems).
5. "Battery connection"
 - "Separate": Separate battery for this UPS.
 - "Common": Common battery in a parallel system.

NOTICE!

"Common": Common battery in a parallel system. When this setting is chosen, the highest battery temperature that can be found in the paralleled systems (for charge voltage compensation).

NOTICE!

Common battery pack is a technical possibility. However, APC recommend separate battery pack due to a higher safety degree in connection with redundant/parallel operation. The UPS system is designed for both situations.





















Programming Parameters

5.3.2 Programming example

Example with four systems in parallel with separate batteries.

- Programme the station addresses 1-4: 1 for UPS 1, 2 for UPS 2, 3 for UPS 3, and 4 for UPS 4.
- All UPS systems have to be programmed to “Highest station address”:4.
- If APM is not to be tested, “APM test mode active” must be “NO”.
- If a system is isolated due to service, the station numbers must be reprogrammed for the remaining active systems starting with number 1 and ending with maximum. number of active systems. No number must be left in this sequence. Furthermore, “Highest station address” must be changed to number of active UPSs in parallel.

5.4 Battery Monitor

Action	Display shows
1. Press  and  simultaneously to prepare for password entry	Key in password :
2. Enter password xx xx xx by pressing      	Last selected parameter
3. Press  or  until message appears:	Expected back-up time [min.]: XXX.X
4. Enter the expected back-up time in minutes at 100% ohmic (pf = 1) load, when the inverter has a mean efficiency of approximately 96% Press    	Expected back-up time [min.]: 14.0
5. Press  to store data	Data stored
6. Press  or  until message appears	Battery capacity in [Ah]: XX.X
7. Press   to set Ah for battery	Battery capacity in [Ah]: 7.0
8. Press  to store data	Data stored
9. Press  to exit	Normal operation load power XX%

5.4.1 Installation of new batteries

To avoid false alarms, the above procedure **MUST** be followed.

NOTICE!

Contact your local dealer if you have any questions regarding changing parameters.

6.0 Options/Accessories

Please contact your local APC representative for information on options/accessories available in your region. See “How to Contact APC” in this guide.

6.1 Service Bypass Panel for Single Operation

UPS	External System Input Fuse [A]	Max. Prospective Short-Circuit Current [kA]	System Input/UPS Input Cable [mm ²] **	System Output/UPS Output Cable [mm ²] **	Max. External System Output Fuse [A]***	Max. Cable Size/ Stud Size	Dimensions HxWxD [mm]	Weight [kg]	Fixing Centres AxB [mm]
480 kW	1000	45	3x185	3x150	800	M12	1825x1160x620 (680*)	250	-

***	If no external System Output fuses are available or if it has a higher value than indicated above, System Output and UPS Output cables should be dimensioned as System Input and UPS Input cables.
**	Sizes according to IEC 364-5-532 for PVC insulated copper cables (max. ambient temperature: 30°C). Installation method B: Insulated conductors in wall conduit. Also refer to local legal regulations. Beware that single-phase Switch Mode Power supply loads will increase neutral current! At a 100% SMPS load, neutral cable should be dimensioned for 200% of phase current.
*	Depth of enclosure includes switch handles

Options/Accessories



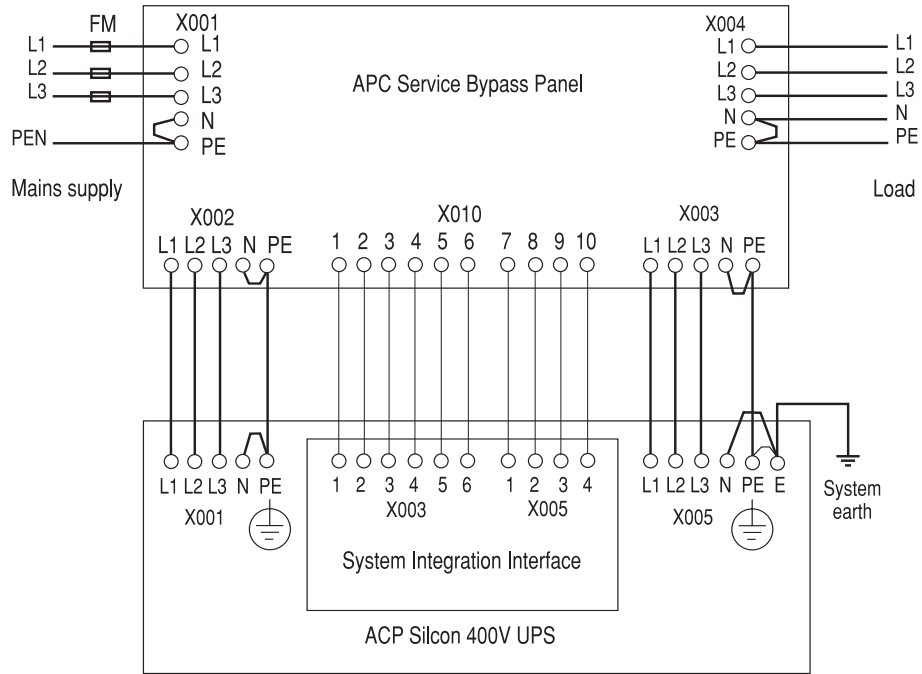



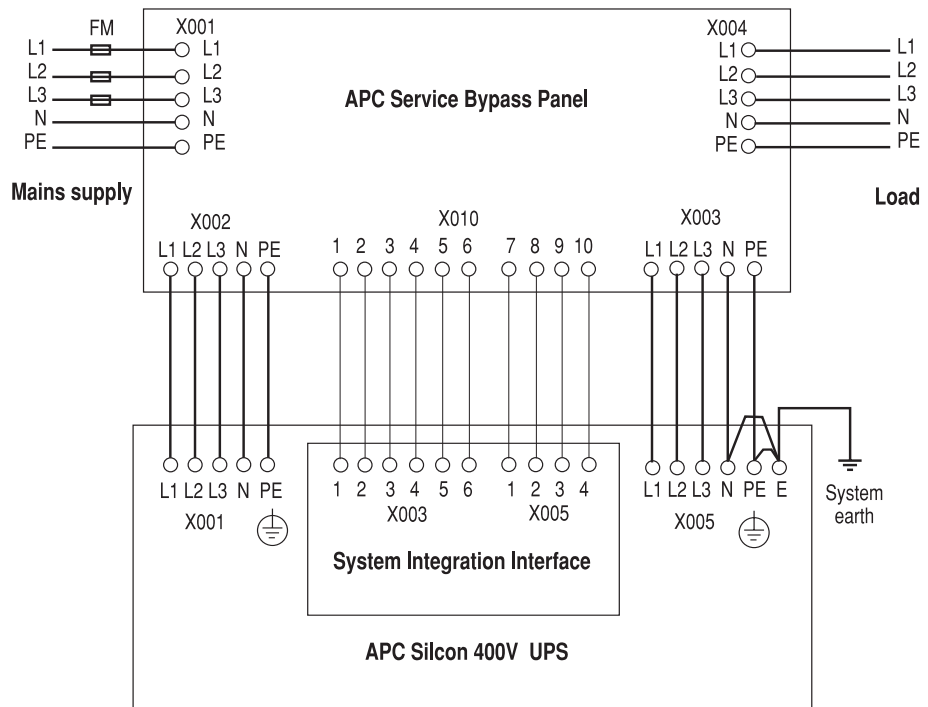

6.1.1 Wiring up UPS with SBP in TN-C-S Network

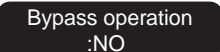

6.1.2 Wiring up UPS with SBP in TN-S Network

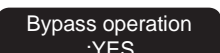

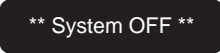









6.1.3 Operating The External Service Bypass Switch

Action	
1. Press  on the keyboard	Display shows
2. Press  or  on the keyboard until	
3. Press  on the keyboard	
4. Press  on the keyboard	Lamp indication on Service Bypass Panel
5. Check lamp indication on the Service Bypass Panel	The Green lamp (H003) above the bypass switch handle (Q003) lights
6. Turn the external bypass switch (Q003) to position "1"	The Green lamp (H002) above the output switch handle (Q002) lights
7. Turn the output switch (Q002) to position "0"	Only the lamp (H002) above the output switch handle (Q002) lights now
8. Open the front door and press both the green "ON" and the red "OFF" keys simultaneously	Display shows
The acoustic alarm sounds for 30 sec.*	
9. Turn the input switch to position "0"	The red alarm LED below the display lights and the acoustic alarm sounds for 30 sec.
* The acoustic alarm can be reset by the  key	

Options/Accessories

6.1.3.1 Switching from External Bypass to Normal UPS Operation

Action	Display shows
1. Turn the input switch (Q002) to position "0"	** System OFF **
2. Open the UPS front door and press the green "ON" key	Normal operation load power %
3. Press  on the keyboard	
4. Press  or  on the keyboard until	Bypass operation :NO
5. Press  on the keyboard	Bypass operation :YES
6. Press  on the keyboard	
7. Check lamp indication on the bypass panel	Lamp indication on Service Bypass Panel The Green lamp (H002) above the output switch handle (Q002) lights
8. Turn the output switch (Q002) to position "1"	Now also the green lamp (H003) above the bypass switch handle (Q003) lights
9. Turn the bypass switch (Q003) to position "0"	Only the Green lamp (H003) above the bypass switch handle (Q003) lights
10. Press  on the keyboard	Display shows
11. Press  or  on the keyboard until	Bypass operation :YES
12. Press  on the keyboard	Bypass operation :NO
11. Press  on the keyboard	Normal operation load power xx %
11. Press  on the keyboard	No lamps on the Service Bypass Panel light any longer

6.2 Service Bypass Panel for Parallel Redundant Operation

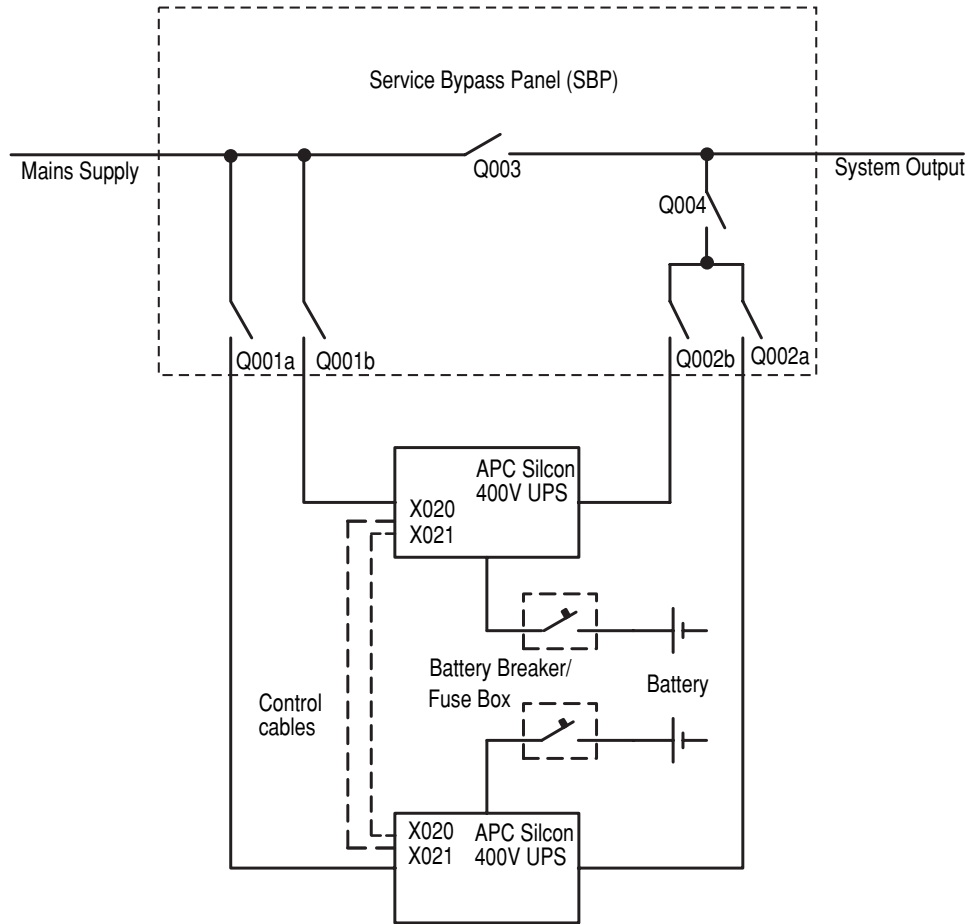

Options/Accessories

6.2.1 Two Parallel Systems with Service Bypass Panel

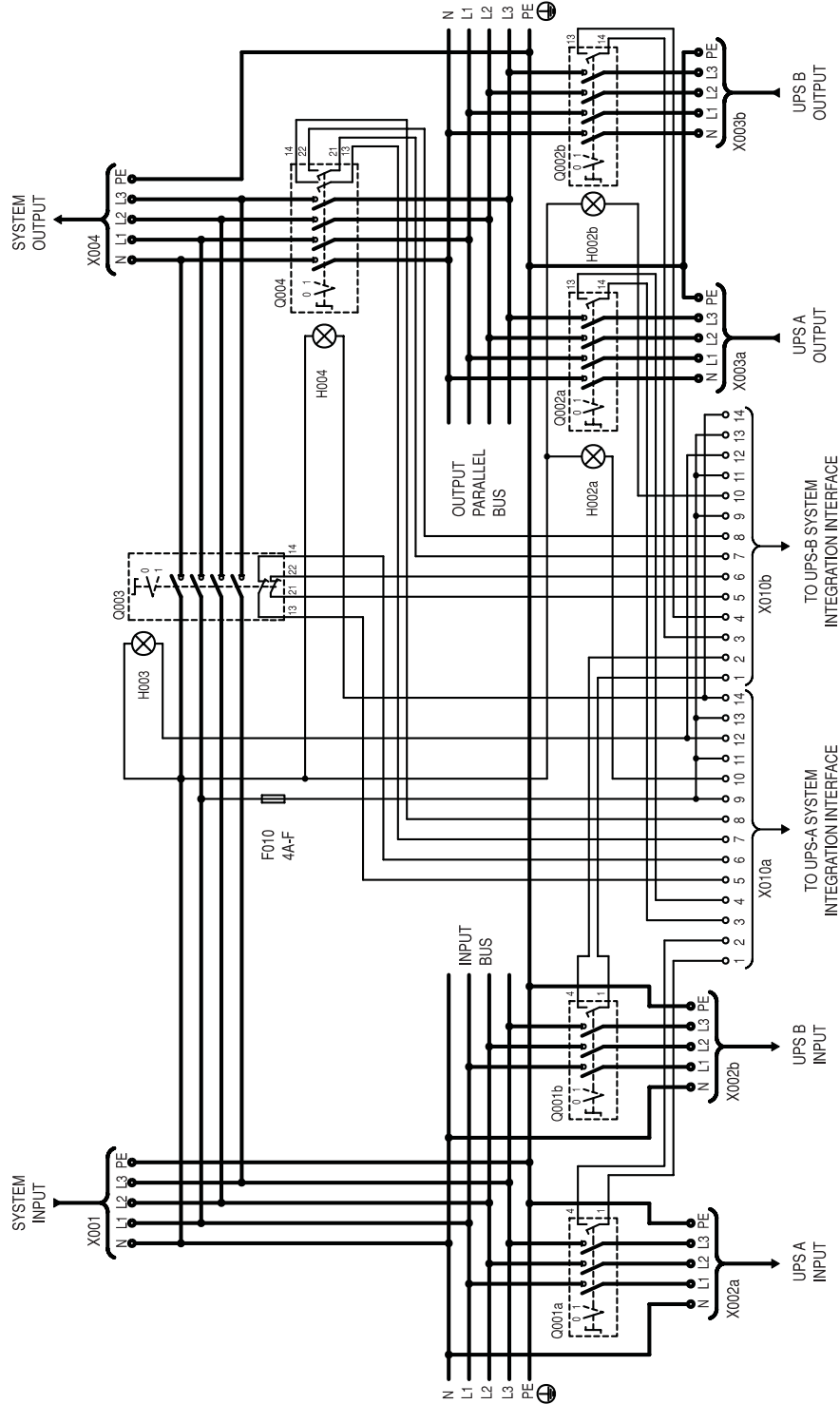

6.2.2 Parallel/Redundant Operation with Service Bypass Panel and External Battery via MCCB

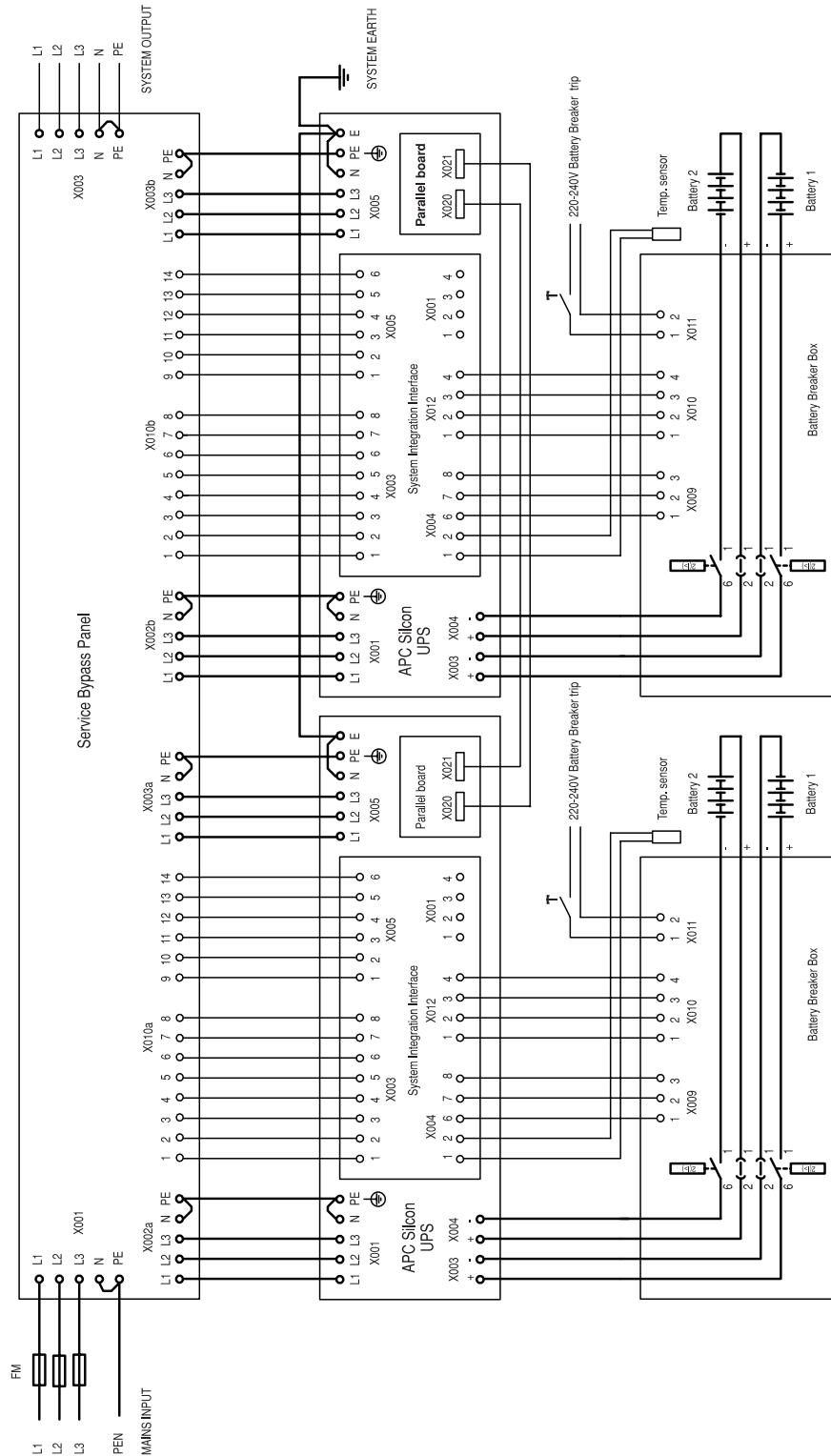

Options/Accessories

6.2.3 Operating External Service Bypass Switch for Parallel Systems



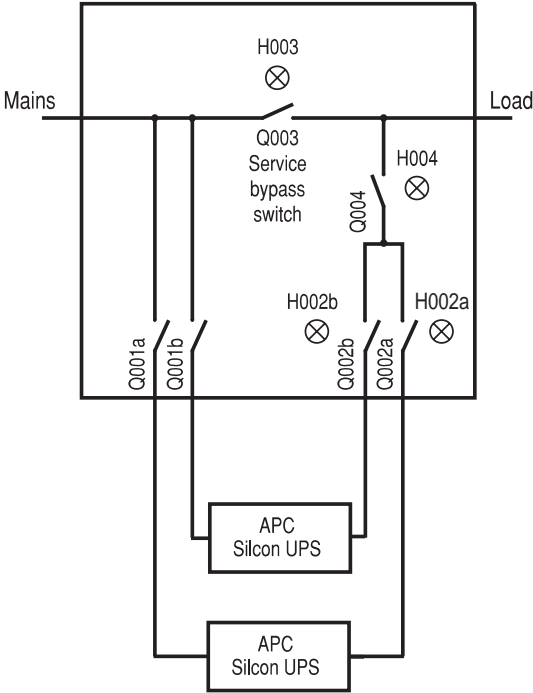

6.2.3.1 Bypassing Parallel UPS Systems



CAUTION!
Batteries connected to a UPS out of service for a period exceeding 8 days may be damaged.

Action

Step 1-4 can be carried out with any of the parallel systems, however this will switch all systems into bypass operation.

- Press  on the keyboard
- Press  or  on the keyboard until
- Press  on the keyboard
- Press  on the keyboard

All systems will transfer to bypass operation

Do not switch off any of the UPS systems until step 5-8 has been completed.

- Check lamp indication on the Service Bypass Panel
- Turn the external bypass switch (Q003) to position "1"
- Turn the output isolator (Q004) to position "0"
- Turn the output switches (Q002) to position "0"
- Open the front door and press both the green "ON" and the red "OFF" keys simultaneously in any of the systems
The acoustic alarm sounds for 30 sec.*
Repeat for (all) other system(s).
- Turn all input switches (Q001) to position "0"
The red alarm LED below the display lights and the acoustic alarm sounds for 30 sec.

* The acoustic alarm can be reset by the  key

Display shows

Bypass operation :NO

Bypass operation :YES

Bypass operation

Lamp indication on bypass panel

The green lamp (H003) above the bypass switch handle (Q003) lights

The green lamp (H004) above the output isolator (Q004) and the green lamps (H002) above the output switch handles (Q002) lights

The green lamps (H002) above the output switch (Q002) light and the green lamp (H004) above the output switch (Q004) lights

Now the lamps (H002) above the output switch handles (Q002) light and the green lamp (H004) above the output switch (Q004) lights





Display shows

** System OFF **

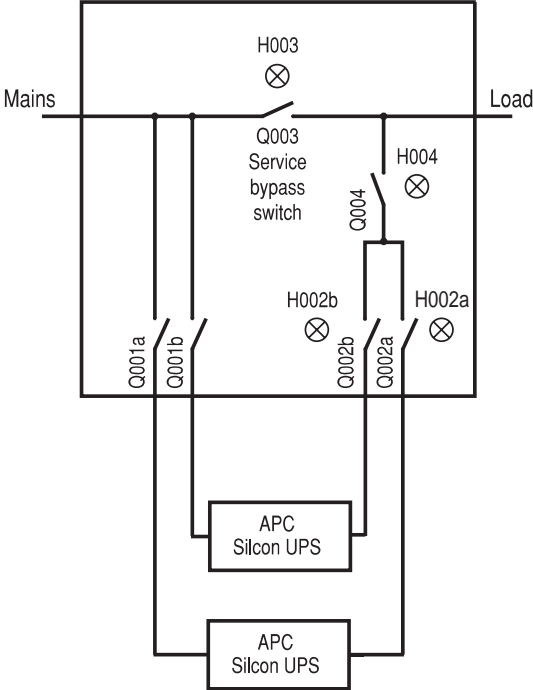



Options/Accessories

6.2.3.2 Switching Parallel System from External Bypass into Normal UPS Operation



Action	Display shows
1. Check that output switch (Q004) is in position "0"	
2. Check that all output switches (Q002) are in position "0"	
3. Turn input switches (Q001) to position "1"	** System OFF **
4. Open the UPS front door and press the green "ON" push-button	Normal operation load power 0%
5. Press  on the keyboard	
6. Press  or  on the keyboard until	Bypass operation :NO
7. Press  on the keyboard	Bypass operation :YES
8. Press  on the keyboard	
All systems will transfer to bypass operation	Bypass operation
	Lamp indication on Service Bypass Panel
9. Check that all output switches (Q002) are in position "0"	The green lamps (H002) above all the output switch handles (Q002) lights.
10. Turn all output switches (Q002) to position "1"	The green lamp (H004) above the output switch (Q004) handle also lights.
11. Turn the output switch (Q004) to position "1"	The green lamps (H002) above all the output switch handles (Q002) light. The green lamp (H004) above the output switch (Q004) handle and the green lamp (H003) above the bypass switch light.
12. Turn the bypass switch (Q003) to position "0"	The green lamps (H002) and (H004) do not light any longer. (H003) will light until normal operation.

Options/Accessories

The following can be carried out on any UPS	Display shows
13. Press  on the keyboard	Bypass operation :YES
14. Press  or  on the keyboard until	Bypass operation :NO
15. Press  on the keyboard	
16. Press  on the keyboard	
All the systems will transfer to normal operation.	Normal operation load power xx% No lamps on the bypass panel lights any longer

6.2.4 Isolating One UPS for Service/Maintenance

In a redundant system, one UPS may be isolated for service/maintenance without affecting other UPSs.

1. Check that remaining UPS(s) is capable of carrying the load in the event that one UPS is isolated
2. Switch off system to be isolated for maintenance purposes by pushing green "ON" and red "OFF" buttons simultaneously
3. To disconnect battery, mains and output, open battery MCCB/fuse and set input switch (Q001) and output switch (Q002) to position "0"

With Q002 in position "0", UPS will be operational and may be tested as a single system without affecting other parallel UPS(s).

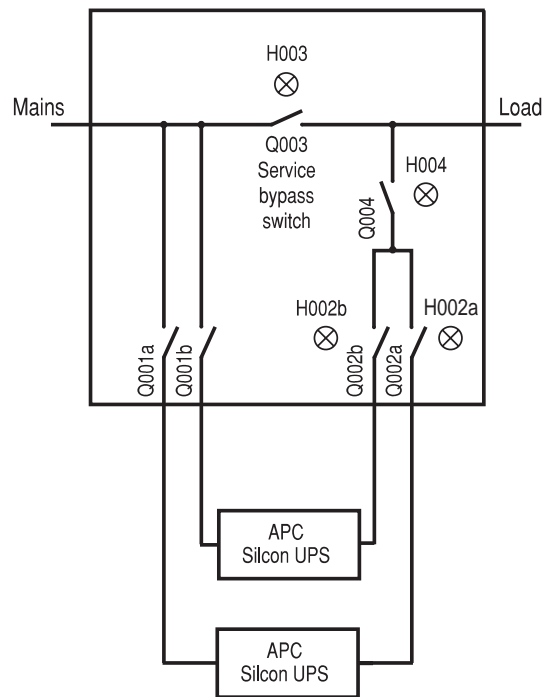

6.2.5 Switching Back to Normal Parallel/Redundant Operation

1. Turn input switch (Q001) and output switch (Q002) to position "1"
2. Charge capacitor, connect battery and start up UPS

UPS will automatically switch to normal operation and start load-sharing with other paralleled UPS(s).



WARNING!

System will discharge built-in capacitors, but check terminal voltage before proceeding.

Options/Accessories

6.3 Intersystem Synchronization Unit

Intersystem Synchronization Unit System (ISU System)

The ISU system consists of inter-connected ISUs. One ISU system may consist of up to 5 ISUs, regardless of ISU configuration. The ISU system synchronizes the voltage of parallel operation systems running in battery operation.

The ISU system may also include one or more external synchronization sources, e.g. a gen-set or a non-APC Silcon UPS system.

Synchronization accuracy of the ISU is better than 2°.

Schematic overview of ISU system (example):

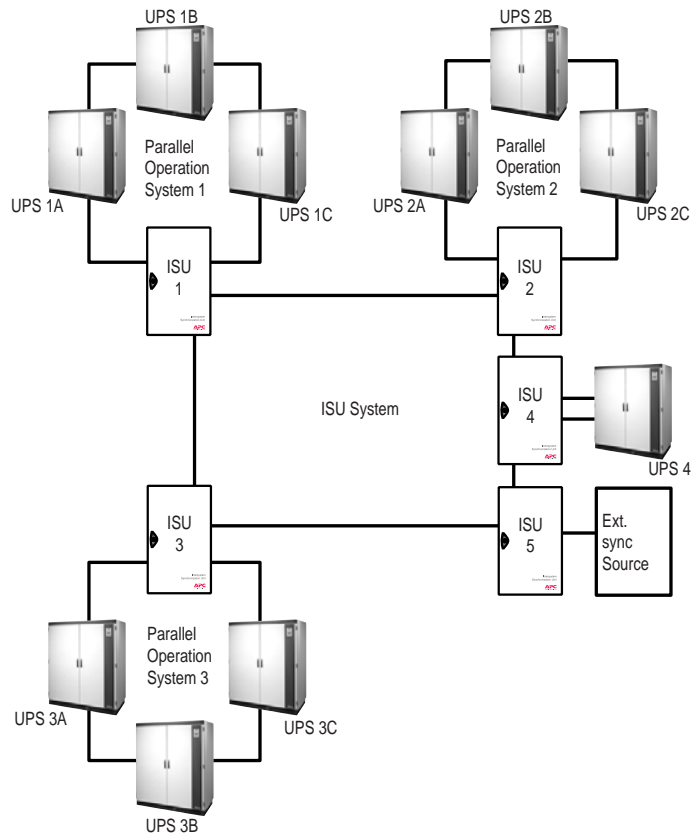

Intersystem Synchronization Unit (ISU)

The ISU is an active part of an ISU system, serving as the interface to the sources and the ISU system.

The ISU can be connected to a parallel UPS configuration, using the standard parallel communication controller in the parallel operation system.

(See Intersystem Synchronization Unit User's Manual for further details.)

6.4 Remote Display



With the remote display unit data may be displayed at distances of up to 25 m from UPS. For extended communication distance, see section below.

Remote display may easily be connected to UPS via one of the two serial communication ports on the communication interface board.

To obtain a transmission distance of up to 3.2 km normal RS232C signal levels must be converted to a long distance communication standard. The converter must be placed outside the UPS cabinet.

6.4.1 Extension of Remote Display Communication Distance

Remote display communicates with the UPS through a 3-wire RS232 interface. Remote display is a DTE (Data Terminal Equipment) employing a SUB-D 9-pin female connector. Communication speed: 9600 bps.

For communication distances, see Table 1. Insert converters if longer distances are necessary, or if communication cables are led through magnetically noisy areas. Converters must comply with local regulations

Table 1: Remote Display Communication Extensions

	Standard (RS232)	Short-haul Modem Async
Max. distance	80/25 ft/m	10000/3200 ft/m
Converter Manufacture Art. Code	No converter	BLACK BOX ME800A-R2
RS232 BLACK BOX connector		Sub-D 25-pin female
BLACK BOX interconnector		4-screw terminal

Two converter boxes are required for a communication distance extension: One box near the UPS for the conversion from RS232C to a long distance communication standard, and another box at the other end to convert back to RS232C, which is to be connected to the Remote Display. The converter provides optical signal insulation. Both converter boxes must be supplied by an uninterruptible power source.

Options/Accessories

6.4.1.1 Connections Without Converter

Connect a 25-pin female Sub-D and a 9-pin male Sub-D connector with a 3-wire shielded cable, as shown in the table below. Connect shield at one end only.

Pin Connection for Interconnection Cable (without converter):

Host (DTE)	Remote Display (DTE)
25-pin female pin No.	9-pin male pin No.
2 (TXD)	2 (RXD)
3 (RXD)	3 (TXD)
7 (GND)	5 (GND)
House (shield)	No Connection

6.4.1.2 Connections With Converter

Connections to be made according to converter manual.

Pinconnection example only:

Pin Connections for cable from host to ME800A-R2.

Host (DTE)	ME800A-R2 (DCE)
25-pin female pin No.	25-pin male pin No.
2 (TXD)	3
3 (RXD)	2
7 (GND)	7
House (Shield)	No connection

Pin connection for cable from ME800A-R2 to Remote Display

ME800A-R2 (DCE)	Remote Display (DTE)
25-pin male pin No.	9-pin male pin No.
3	2 (RXD)
2	3 (TXD)
7	5 (GND)
No connection	House (Shield)

The ME800A-R2 must be set up as a DCE with no RTS/DTR control.

The interconnection cable between the two ME800A-R2 boxes is a 4-wire twisted pair telephone cable with or without shield. The shield improves noise immunity but reduces maximum communication distance.

6.4.2 Remote Display Installation

6.4.2.1 Connecting RS232C and Mains Adapter



CAUTION!

Wiring for alarm and signal circuit field to be rated 300V (minimum).

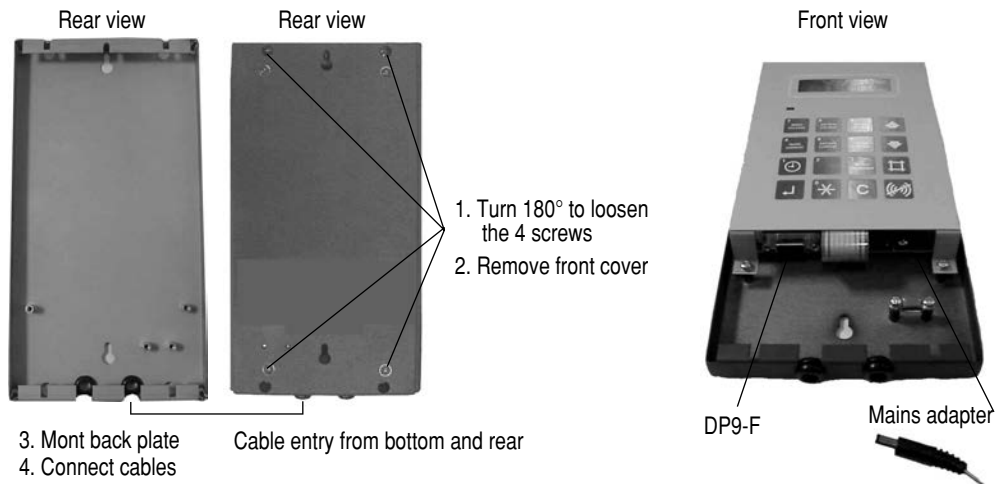

6.4.2.2 Remote Display Power Supply

The remote display is supplied by normal AC power with no battery back-up. For UPS data transmission to remote display to remain unaffected during power failure, the remote display must be supplied from an uninterruptible power source.

Converters used to extend communication distance must also be supplied from uninterruptible power sources.

6.4.2.3 Remote Display Cables

RS232C to RS232C cable:

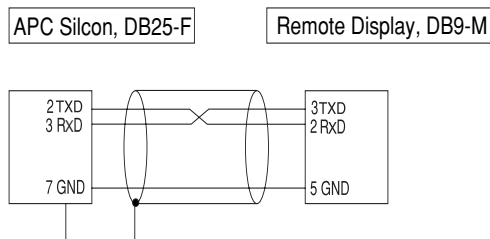

Connect shield at one end only!
Rating: Refer to Local/National electrical codes.
Communication voltage $\pm 15V_{DC}$

Options/Accessories

6.4.3 Remote Display Use

The remote display is an inactive unit unable to influence the operation of the UPS: Some of the alarms visible on the internal display are also available on the remote display (See the Alarm section in the APC Silcon User Guide).

6.4.3.1 Initiating the Remote Display

After having connected the supply the display will show:

Remote Display: “APC Silcon UPS”

6.4.3.2 Communication Fault

Communication fault between UPS and remote display will appear in the display as follows:

“Data transmission interrupted”

6.4.3.3 Remote Display Setting

Use # Stack to select language and type of UPS connected to remote display.

Parameter	Setting	Comments
Language	GB,D,F,DK, S, SF,NL, PL, CZ, E, P, SK, H, I	Language
Host	SDC charger, DP300E, 300E	Type of UPS connected to remote display

6.4.3.4 Operation

See the Operation section in the APC Silcon User Guide.

6.4.3.5 Display of Measured Value

See Display of Measured Value in the APC Silcon User Guide.
Time reading not visible from the remote display.

6.4.3.6 Alarms

See Alarms section in the APC Silcon User Guide.

6.5 Isolation Transformer

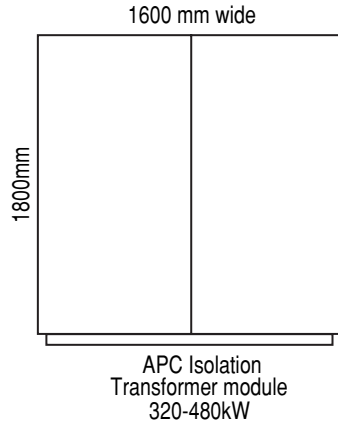

UPS	Height [mm]	Width [mm]	Depth [mm]	Weight [kg]
480kW	1800	1600	800	1950

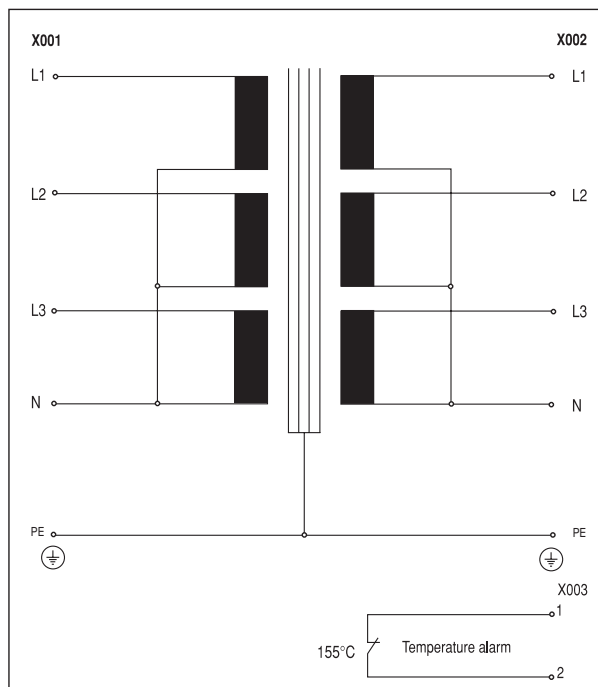

Example of Transformer Configuration (Yyno)

NOTICE!

APC isolation transformers are available in various configuration. Contact your local APC representative for further information. See "How to Contact APC" in this guide.

Options/Accessories

6.5.1 Connecting Isolation Transformer

NOTICE!

Check correct phase rotation of mains input voltage! Maximum input/output for cables: 3//300 mm². If input neutral is not available, an optional Dzn0 or Dyn11 input isolation transformer must be used.

NOTICE!

All external cable dimensions are recommended sizes only. Refer to local legal regulations.

NOTICE!

Make sure that gland plate is installed in bottom of cabinet.

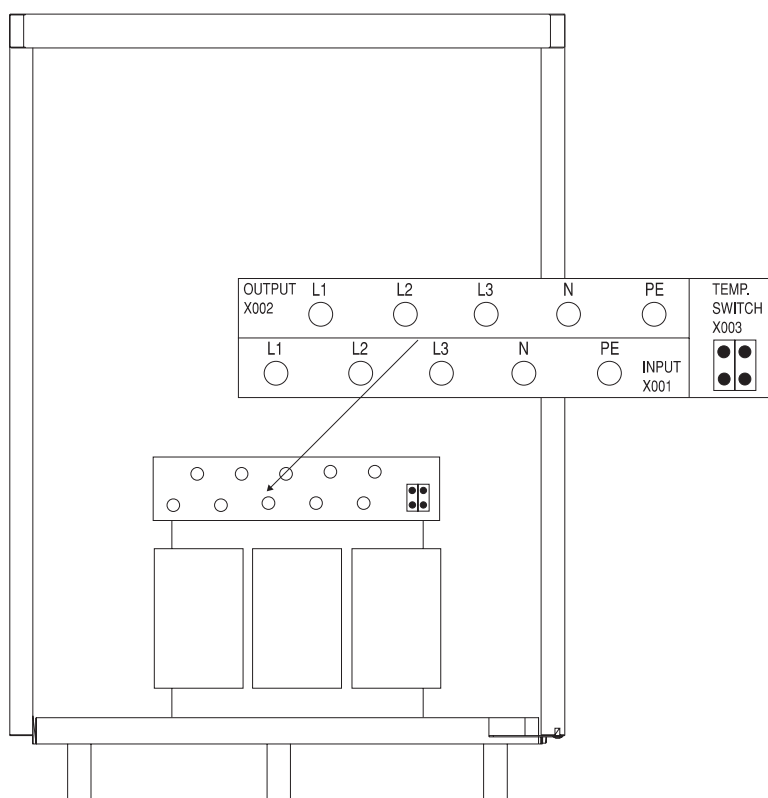

CAUTION!

At 100% switch mode load, neutral must be rated for 200% phase current

Options/Accessories

Isolation Transformer	External Input Fuses* FM [A] 380-415V	External Input Cable [mm2] 380-415V	External PE Cable [mm2]	External Output Cable [mm2]	External Temp. Signal Cable [mm2]
480kW	1000	3//185	185	3//185	2

*DIN gL types

PVC cables insulated to withstand a maximum ambient temperature of 30°C

Options/Accessories

6.5.2 Wiring up UPS with External Yyn0 Isolation Transformer at Output

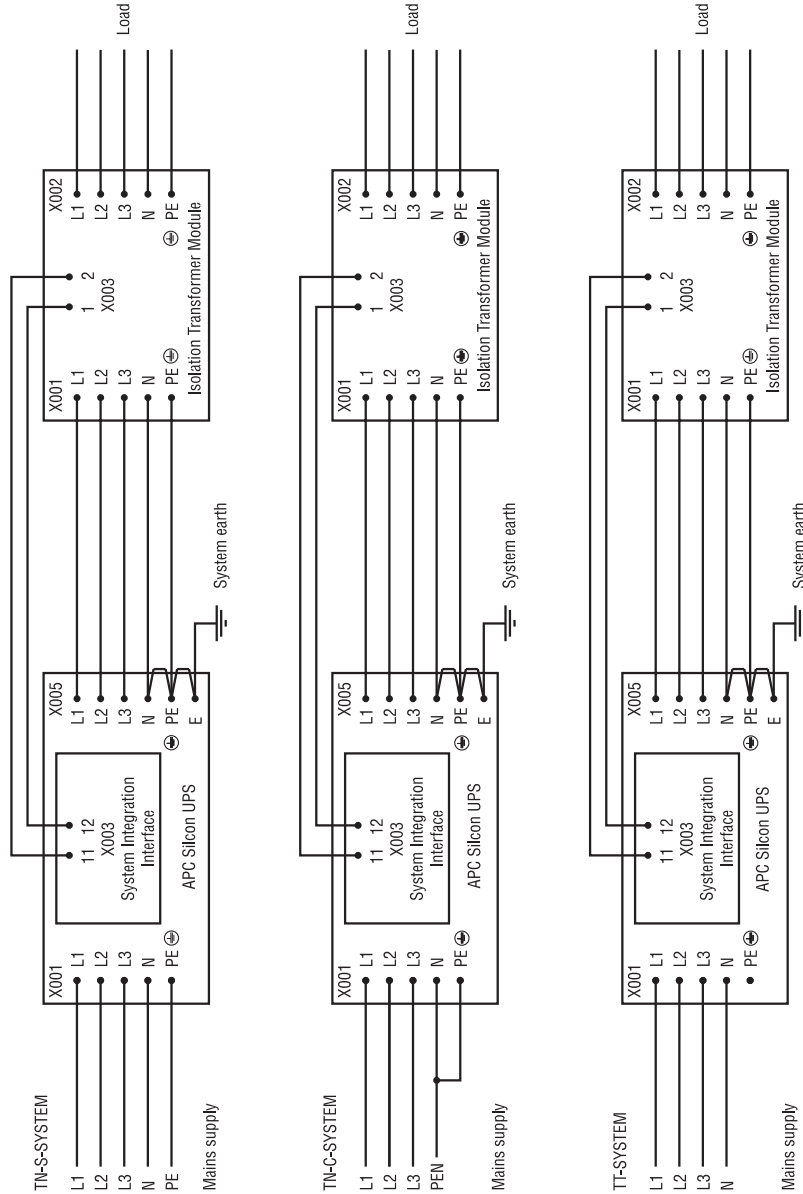

WARNING!

Isolation transformer provides galvanic isolation between mains supply and load. Load will loose galvanic isolation if isolation transformer is bypassed

NOTICE!

Refer to local legal regulation for wiring information.

6.5.3 Wiring up UPS with External Yyn0 Isolation Transformer at Input

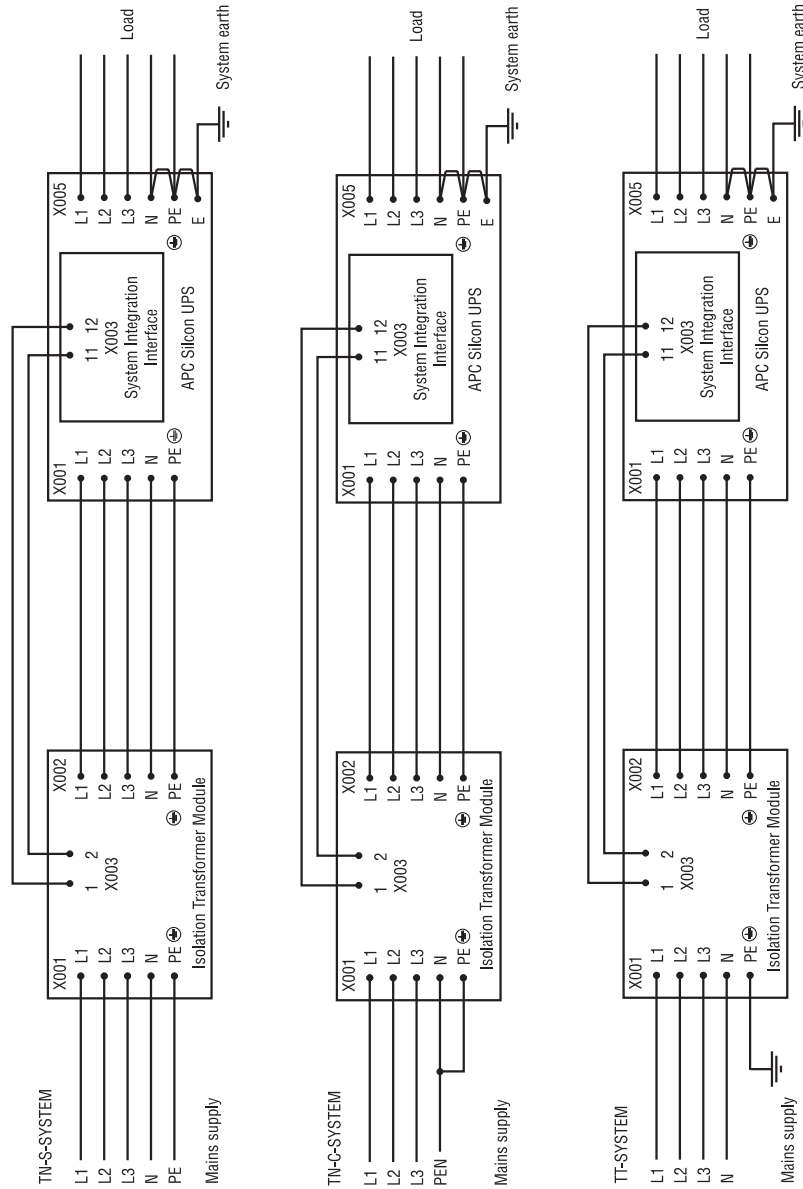

WARNING!

Isolation transformer provides galvanic isolation between mains supply and load. Load will lose galvanic isolation if isolation transformer is bypassed.

NOTICE!

Refer to local legal regulation for wiring information.

Options/Accessories

6.5.4 Wiring up UPS with External Optional Dzn0 Isolation Transformer at Input

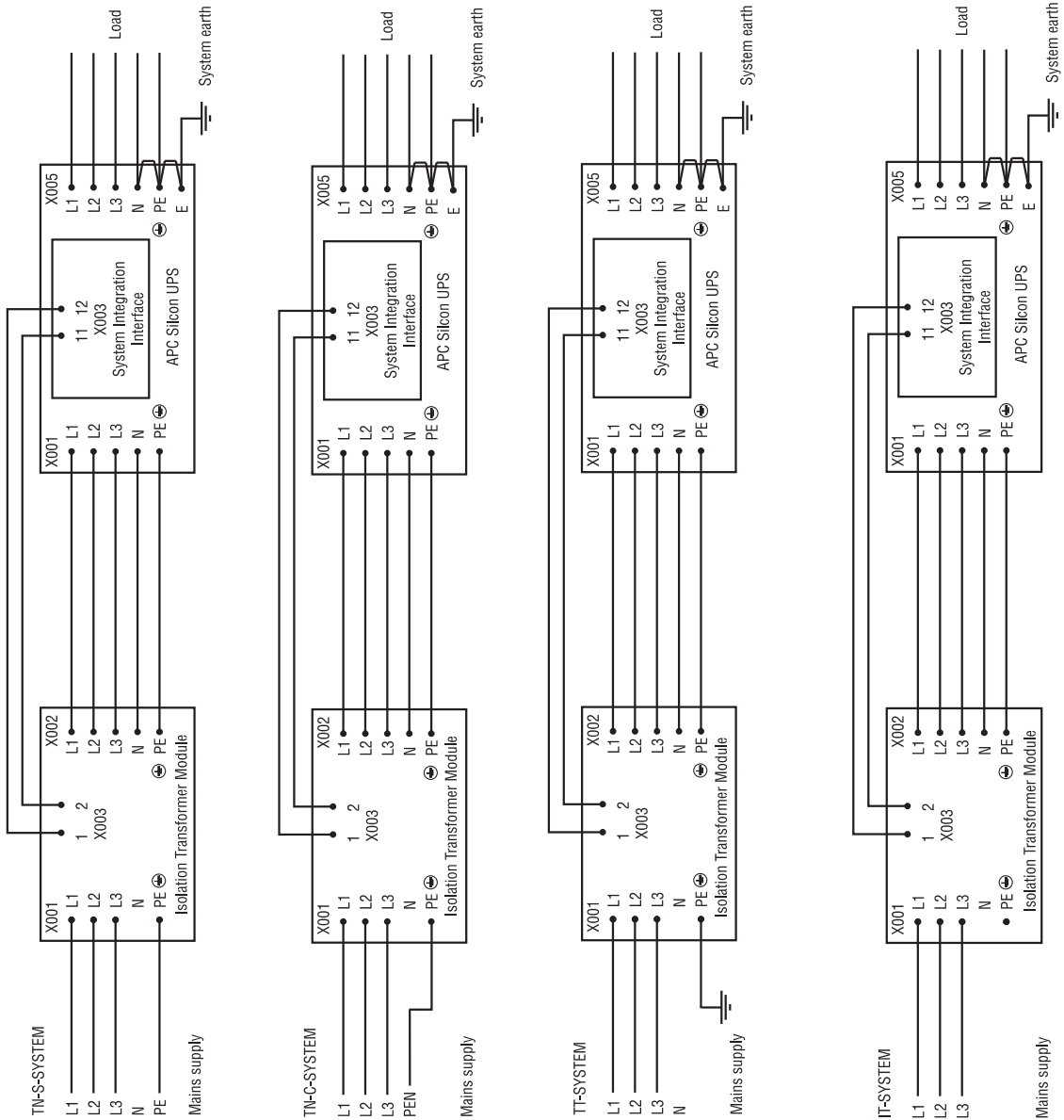

WARNING!

Isolation transformer provides galvanic isolation between mains supply and load. Load will lose galvanic isolation if isolation transformer is bypassed.

NOTICE!

Refer to local legal regulation for wiring information.

6.5.5 Wiring up UPS with External Optional Dzn0 Isolation Transformer at Output

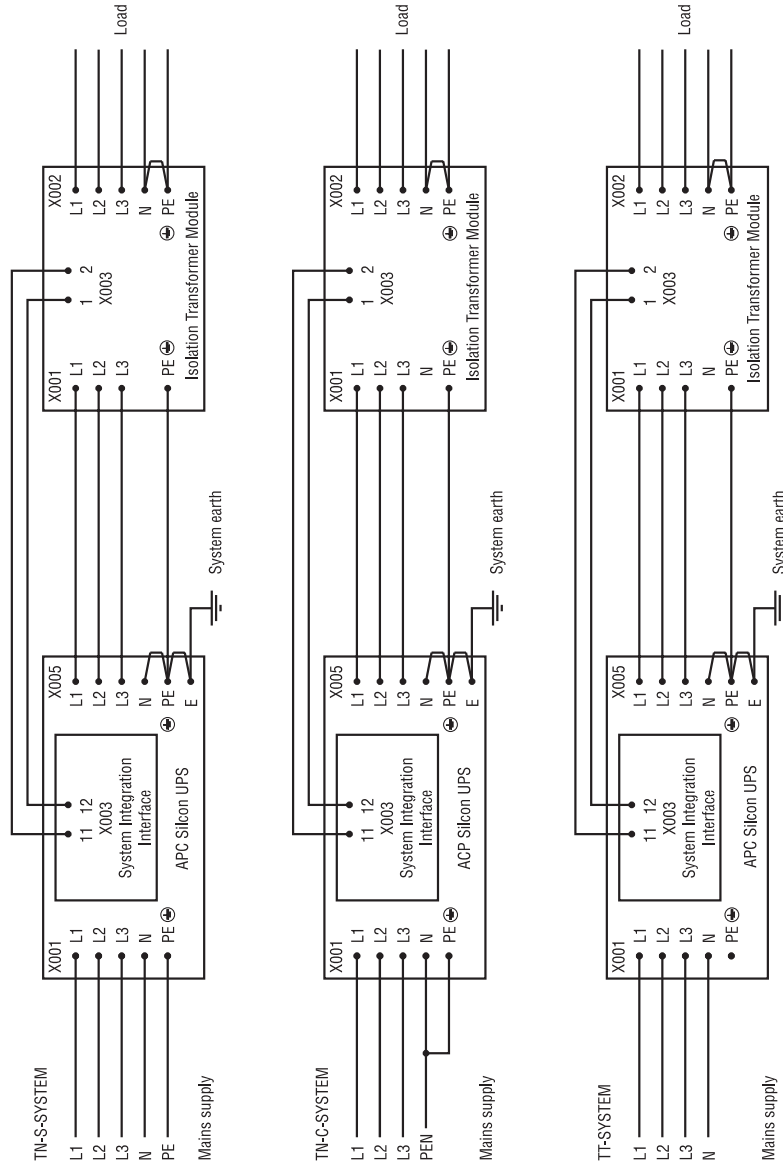

WARNING!

Isolation transformer provides galvanic isolation between mains supply and load. Do not bypass isolation transformer in order to avoid damaging circulation currents and to prevent load from losing galvanic isolation.

NOTICE!

Refer to local legal regulation for wiring information.

Options/Accessories

6.5.6 Wiring up UPS with External Optional Dyn11 Isolation Transformer at Input

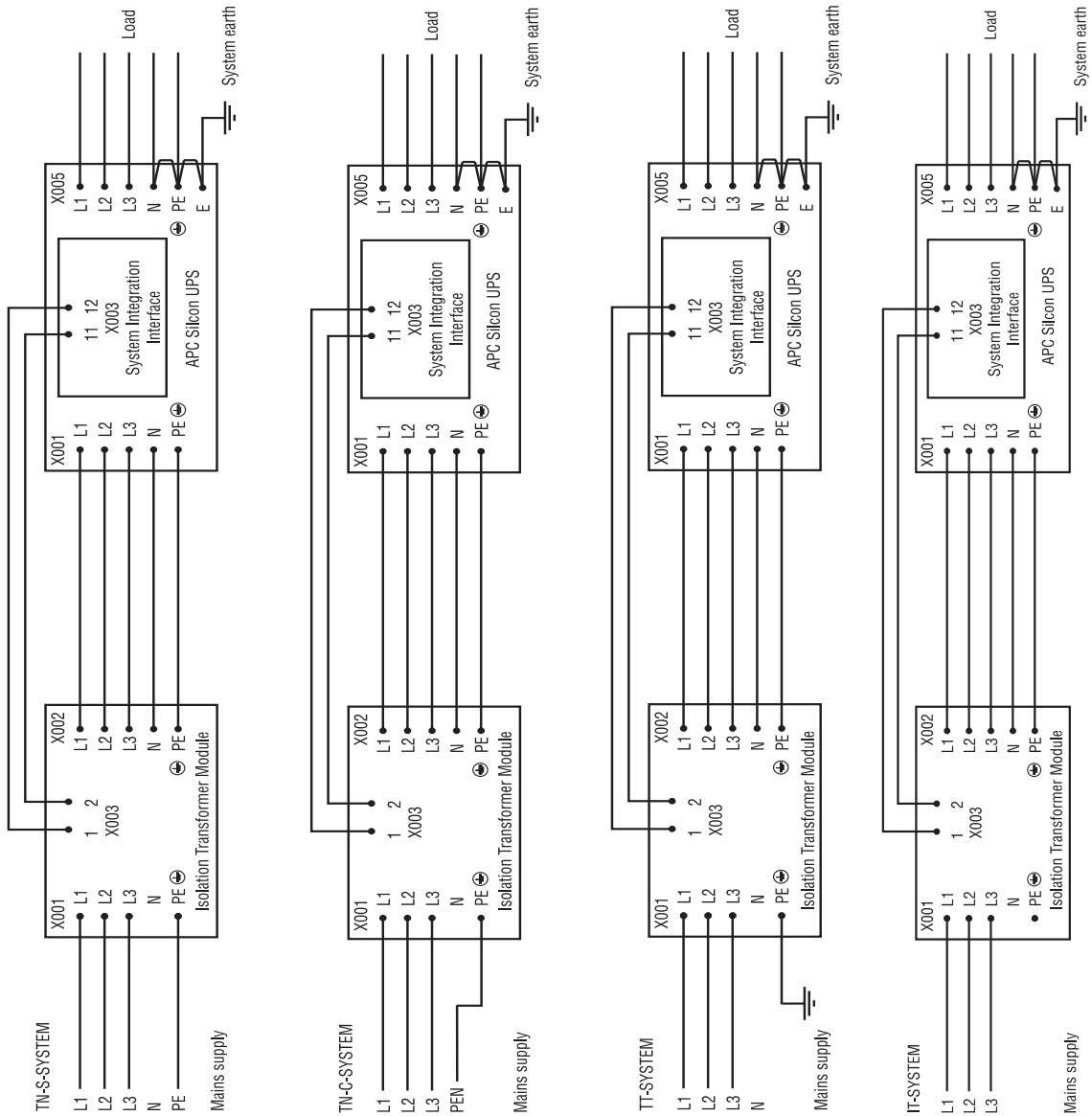

WARNING!

Isolation transformer provides galvanic isolation between mains supply and load. Do not bypass isolation transformer in order to avoid damaging circulation currents and to prevent load from losing galvanic isolation.

NOTICE!

Refer to local legal regulation for wiring information.

System Specifications

7.0 System Specifications

7.1 Technical Data

	Voltage	3x380/400/415V
Input	Voltage tolerance Normal operation Bypass operation	±15% ±10% (standard) ±4, 6, 8% (programmable)
	Frequency	50Hz/60Hz ±6 standard ±0.5-8% (programmable)
	Input power factor	load 25% minimum 0.97 load 100% minimum 0.99
	Current distortion	Max. 5%
Output	Voltage	3x380/400/415V
	Voltage tolerance	±1% static symmetrical load ±3% static symmetrical load ±5% 0-100% load step
	Voltage distortion	max. 3% linear load max. 6% non-linear load
	Load power factor	0.9 lead to 0.8 lag
	Frequency	50Hz/60Hz (mains synchronized) ±0.1% free-running
	Overload capacity Mains operation Mains operation Battery operation Bypass operation	200% - 60 seconds 125% - 10 minutes 150% - 30 seconds 125% - continuous
General	Ambient temperature	0-40°C (Temperatures above 25°C will reduce battery lifetime)
	Humidity Protection class Safety Emission and Immunity Static bypass switch Auto restart Economy mode	Max. 95% non-condensing IP30 EN 50091-1 CE Mark EN 50091-2 Built-in Programmable Programmable

7.2 Dimensions / Weight

Type	480kW
Height [mm]	1800
Width [mm]	1900
Depth [mm]	800
Weight [kg]	1800

Warranty

8.0 Warranty

8.1 APC Silcon Series Limited Factory Warranty

APC warrants that the unit, when properly installed and commissioned by APC or APC authorized service personnel, shall be free from defects in materials and workmanship for a period of (1) year from the date of installation or maximum 18 months after manufacturing. In the event that the unit fails to meet the foregoing warranty, APC shall for a period of one (1) year repair or replace any defective parts, without charge for on-site labor and travel if trained & authorized APC personnel has conducted start-up of the unit.

An APC Start-Up Service must be performed/completed by APC or APC authorized service personnel or the on-site factory warranty will be voided and replacement of defective parts only will be covered. APC shall have no liability and no obligation to repair the installed unit if non-authorized APC personnel performed the start-up and such start-up caused the unit to be defective.

APC SHALL NOT BE LIABLE UNDER THE WARRANTY IF ITS TESTING AND EXAMINATION DISCLOSE THAT THE ALLEGED DEFECT IN THE PRODUCT DOES NOT EXIST OR WAS CAUSED BY PURCHASER'S OR ANY THIRD PERSON'S MISUSE, NEGLIGENCE, IMPROPER INSTALLATION OR TESTING, UNAUTHORIZED ATTEMPTS TO REPAIR OR MODIFY, OR ANY OTHER CAUSE BEYOND THE RANGE OF THE INTENDED USE, OR BY ACCIDENT, FIRE, LIGHTNING OR OTHER HAZARD.

THERE ARE NO WARRANTIES, EXPRESS OR IMPLIED, BY OPERATION OF LAW OR OTHERWISE, OF PRODUCTS SOLD, SERVICED OR FURNISHED UNDER THIS AGREEMENT OR IN CONNECTION HERewith. APC DISCLAIMS ALL IMPLIED WARRANTIES OF MERCHANTABILITY, SATISFACTION AND FITNESS FOR A PARTICULAR PURPOSE. APC'S EXPRESS WARRANTIES WILL NOT BE ENLARGED, DIMINISHED, OR AFFECTED BY AND NO OBLIGATION OR LIABILITY WILL ARISE OUT OF, APC'S RENDERING OF TECHNICAL OR OTHER ADVICE OR SERVICE IN CONNECTION WITH THE PRODUCTS. THE FOREGOING WARRANTIES AND REMEDIES ARE EXCLUSIVE AND IN LIEU OF ALL OTHER WARRANTIES AND REMEDIES. THE WARRANTIES SET FORTH ABOVE, CONSTITUTE APC'S SOLE LIABILITY AND PURCHASER'S EXCLUSIVE REMEDY FOR ANY BREACH OF SUCH WARRANTIES. APC'S WARRANTIES RUN ONLY TO PURCHASER AND ARE NOT EXTENDED TO ANY THIRD PARTIES.

IN NO EVENT SHALL APC, ITS OFFICERS, DIRECTORS, AFFILIATES OR EMPLOYEES BE LIABLE FOR ANY FORM OF INDIRECT, SPECIAL, CONSEQUENTIAL OR PUNITIVE DAMAGES, ARISING OUT OF THE USE, SERVICE OR INSTALLATION, OF THE PRODUCTS, WHETHER SUCH DAMAGES ARISE IN CONTRACT OR TORT, IRRESPECTIVE OF FAULT, NEGLIGENCE OR STRICT LIABILITY OR WHETHER APC HAS BEEN ADVISED IN ADVANCE OF THE POSSIBILITY OF SUCH DAMAGES.

9.0 Appendix

9.1 Table 1. Installation Planning Data

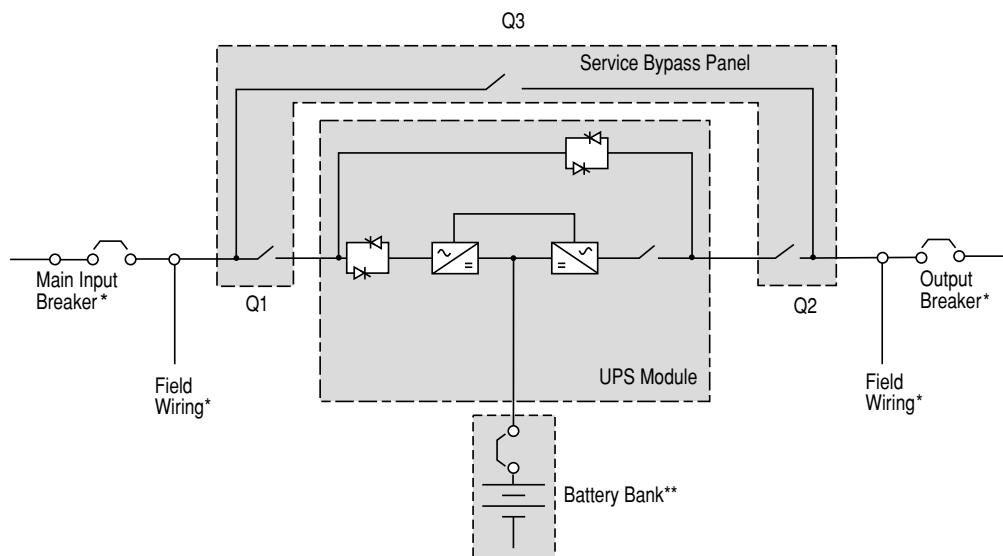

* Not supplied by APC

** Internal Batteries available for 40kW units and smaller

Installation Planning Data
APC Silcon Series

Power rating			AC Input							Battery System DC				AC Output			
			Source		P (kW)		I (A)		Min. Input Cable	Input Overcurrent Protection*	V _n	Full load P(kW)	I _{Nom} Disch (A)	I _{Max} Disch (A)	I _n (A)	Load side Overcurrent Protection*	Heat Dissipation (kW)
kW	kVA	Pf	V	Hz	Nom.	Max.	Nom.	Max.	(per phase)		(Vdc)						
480	480	1	380 400 415	50/60	491.8	569.5	838.3 747.3 768.4	922.1 822.0 845.2	3//185mm ²	1000 A	2x384	505.3	658	775	727.3 695.7 666.7	800 A	15.9
COLUMN			1a	1b	1c	1d	1e	1f	1g	1h	2a	2b	2c	2d	3a	3b	4a
NOTES					3	4	1	2	9	5, 6, 13	8	12	10	11		6, 7	13

* Provided by others

Appendix

Notes:

1. Nominal input current based on rated load.
2. Maximum input current based on rated load + full battery recharge. Full battery recharge assumed to increase input current with 10%.
3. Nominal power consumption (column 1c) based on nominal input current (1e) and the corresponding input voltage (1a).
4. Maximum power consumption (1d) based on maximum input current (1f) and the corresponding input voltage (1a).
5. Suggested input overcurrent protection (1h) based on continuous full load maximum input current (1f). MCCB breaker selection based on continuous full load nominal input current (1e) is acceptable, provided battery recharge time is short.
6. Fuses according to DIN LV HRC type gL, 500V assumed. MCCB load capacity must be $8 \times I_n$ (nominal current) for minimum 10ms.
7. Suggested load side overcurrent protection (3b) based on nominal output current (3a).
8. Nominal battery voltage assumed to be 2V/cell (Lead technology).
9. Recommended cable sizes, see "External Connection" section of this guide.
CAUTION! Cable sizes must comply with national and/or local legal regulations.
10. Nominal battery discharge current (2c) based on full rated load and nominal battery voltage (2V/cell).
11. Maximum battery discharge current (2d) based on full rated load and battery voltage at end of discharge (1.7V/cell).
12. Full load discharge power from battery based on nominal battery discharge current (2c) x nominal battery voltage (2x192cells x 2V/cell), or maximum battery discharge current (2d) x battery voltage at end of discharge (2x192cells x 1.7 V/cell).
13. Heat dissipation based on nominal full load capacity and linear load.

10.0 How to Contact APC



APC Corporate
132 Fairgrounds Road
West Kingston, RI 02892
USA

Telephone: 401 789-5735
Fax: 401 789-3710

PowerFax™: 800 347-FAXX

Pre-sales Technical Support
877-474-5266 (1-877-4Silcon)

Post-sales Technical Support
877-287-7835 (1-877-2UPS-TEK)

Web: www.apcc.com/support/contact/contact_support.cfm

APC Denmark
Silcon Allé
DK-6000 Kolding
Denmark

Telephone: + 45 75 54 22 55
Fax: + 45 72 19 03 50

Pre-sales Technical Support
+ 45 72 19 04 90

Post-sales Technical Support
+ 353 91 70 2000

Web: www.apcc.com/support/contact/contact_support.cfm

