



**ИБП ABB Powervalue 11 RT (1-3 кВА) - руководство по эксплуатации. Юниджет**

Постоянная ссылка на страницу: <https://www.uni-jet.com/catalog/ibp/online-ibp/abb-powervalue-11-rt/>



# PowerValue 11 RT

1-3 kVA B

1-3 kVA S



# About this manual

The UPS system operates with mains, battery or bypass power. It contains components that carry high currents and voltages. When installed correctly, the UPS system is grounded to earth and IP 20 rated against electrical shock and foreign objects.

This user manual contains guidelines to check delivery, install and commission the UPS and is intended for people who plan the installation, install, commission and use or service the UPS. The reader is expected to be familiar with the fundamentals of electricity, wiring, electrical components and electrical schematic symbols.











FOLLOW THE INSTRUCTIONS IN THIS MANUAL DURING INSTALLATION, OPERATION AND MAINTENANCE OF THE UPS AND BATTERIES.

FAILURE TO FOLLOW THE INSTRUCTIONS MAY LEAD TO THE PRODUCT LOSING ITS WARRANTY.

Read this manual before performing any operations and store it for future reference.

## Symbols

The following symbols are used in this user manual.

WARNING	WARNING INDICATES THE PRESENCE OF A HAZARD WHICH COULD RESULT IN SEVERE INJURY AND/OR SERIOUS DAMAGE TO THE SYSTEM
CAUTION	CAUTION INDICATES THE PRESENCE OF A HAZARD WHICH COULD RESULT IN MINOR INJURY AND/OR DAMAGE TO THE PRODUCT.
NOTE	NOTE INDICATES THE PRESENCE OF A HAZARD WHICH COULD LEAD TO PROPERTY DAMAGE.
	SAFETY WARNING: THE SYMBOL IS USED TO ALERT THE USER TO WARNINGS, CAUTIONS AND NOTES.
	DANGER: THE SYMBOL IS USED TO ALERT THE USER TO THE OCCURRENCE OF ELECTRICAL LIVE PARTS WITH HAZARDOUS VOLTAGES.
	Protective grounding terminal: A terminal which must be connected to earth ground prior to making any other connections to the equipment.
	A terminal to which or from which an alternating current or voltage (AC) may be applied or supplied.
	A terminal to which or from which a direct current or voltage (DC) may be applied or supplied
	Battery
	Power On, Idle or shutdown the UPS
	Overload indication
	Recycle
	Do not dispose with ordinary trash

# Contents

<b>1</b>	<b>Safety instructions</b>	<b>5</b>
1.1	Operator precautions	5
1.2	Environmental Considerations	5
1.5	Operation	6
1.3	Declaration of Safety conformity and CE marking	6
1.4	Inquiries	6
<b>2</b>	<b>Maintenance</b>	<b>7</b>
2.1	Replacing internal batteries	8
2.2	Testing new batteries	9
2.3	Battery recycling	9
<b>3</b>	<b>Installation</b>	<b>11</b>
3.1	Delivery, transportation, positioning and storage	11
3.2	Site planning and positioning	11
3.3	General characteristics	18
3.4	Electrical installation	21
3.5	Emergency power off (EPO)	22
3.6	Installation checklist	22
<b>4</b>	<b>Operation</b>	<b>23</b>
4.1	Control Panel	23
4.2	Operating Mode	24
4.3	UPS start-up and shutdown	26
4.4	UPS operation	27
<b>5</b>	<b>Communication</b>	<b>33</b>
5.1	RS-232 port	33
5.2	USB port	33
5.3	Dry contact ports	33
5.4	Network management card (optional)	34
<b>6</b>	<b>Troubleshooting</b>	<b>35</b>
	<b>Appendix A</b>	<b>36</b>
	<b>Appendix B</b>	<b>37</b>
	<b>Appendix C: External Battery Modules (EBM) value calculation</b>	<b>38</b>



# 1 Safety instructions



## 1.1 Operator precautions



Always follow the precautions and instructions described in this manual. Any deviations from the instructions may result in electrical shock or cause accidental load loss.

Only the following user operations are permitted:

- Use of the LCD control panel (LCD Display) and Maintenance Bypass (if present)
- Start up and shut down of the UPS (excluding the commissioning start up)
- Operation of additional connectivity devices

ABB DOES NOT TAKE ANY RESPONSIBILITY FOR DAMAGES CAUSED THROUGH INCORRECT MANIPULATIONS OF THE UPS SYSTEM.

	<b>DANGER</b>	<b>DO NOT REMOVE ANY SCREWS FROM THE UPS SYSTEM OR FROM THE BATTERY CABINET: DANGER OF ELECTRICAL SHOCK.</b>
	<b>WARNING</b>	

	<b>DANGER</b>	<b>HIGH FAULT CURRENTS (LEAKAGE CURRENTS). BEFORE CONNECTING THE MAINS ENSURE THAT THE UPS IS GROUND!</b>
	<b>WARNING</b>	

## 1.2 Environmental Considerations

To operate the UPS with optimal efficiency, your installation site should meet the environmental parameters outlined in this user manual. Excessive amount of dust or moisture in the operating environment may cause damage or lead to malfunction. The UPS should always be protected from the weather and sunshine. The operating environment must meet the weight, airflow, size and clearance requirements specified in the technical datasheet.

Under no circumstances install the UPS in an airtight room, in the presence of flammable gases, or in an environment exceeding the environmental requirements specified below.

An ambient temperature of +20°C to +25°C is recommended to achieve a long life of the UPS and batteries. The cooling air entering the UPS must not exceed +40 °C and the humidity should be below 95% (non-condensing).

### 1.3 Declaration of Safety conformity and CE marking

**PowerValue 11 RT** is designed, manufactured and commercialized in accordance with the standard **EN ISO 9001** of Quality Management Systems.

The products conform with the following directives:

- **2014/35/EU** Low voltage directive.
- **2014/30/EU** Electromagnetic Compatibility directive (EMC).
- **2011/65/EU** Restriction of the use of certain hazardous substances (RoHS) directive



The product conforms with the product standards shown in Table 1.

	Product Standards
Safety	IEC/EN 62040-1:2008+A1:2013
EMC	IEC/EN 62040-2:2006
RoHS	IEC/EN50581:2012

Table 1: Product standards

### 1.4 Inquiries

Address inquiries about the UPS to the local ABB office or agent authorized by ABB. Note the type code and the serial number of the equipment before contacting ABB or authorized agent. The serial number is shown in the nameplate of the product. For further information on troubleshooting, see Chapter 6.

### 1.5 Operation



CAUTION

DO NOT DISCONNECT THE MAINS CABLE FROM THE UPS OR THE BUILDING WIRING SOCKET DURING OPERATION AS THIS REMOVES THE GROUND FROM THE UPS AND ALL CONNECTED LOADS.



CAUTION

AN INTEGRAL SINGLE EMERGENCY SWITCHING DEVICE THAT PREVENTS FURTHER SUPPLY TO THE LOAD BY THE UPS IN ANY MODE OF OPERATION MUST BE PROVIDED IN THE BUILDING WIRING INSTALLATION.



NOTE

PRESS THE OFF BUTTON TO FULLY DISCONNECT THE UPS. WAIT UNTIL THE UPS IS ON BYPASS OR ON STAND-BY MODE BEFORE DISCONNECTING IT FROM THE MAINS.



CAUTION

INDISCRIMINATE OPERATION OF SWITCHES MAY CAUSE OUTPUT LOSS OR DAMAGE TO EQUIPMENT.

## 2 Maintenance

PowerValue 11 RT UPS requires only minimal maintenance.

Charge the UPS regularly to maximize the expected life of the battery. When connected to the mains power, the UPS charges the batteries and prevents the batteries from overcharging and over-discharging.

- Replace the batteries when the battery service life has been exceeded (3~5 years at 25°C ambient temperature). Contact local ABB or an agent authorized by ABB.
- Charge the UPS once every 4 to 6 months if it has not been used for a long time. The batteries charge to 90% capacity in approximately 4 hours. It is recommended that the batteries charge for 48 hours after long-term storage.
- In high temperature regions, charge and discharge the battery every 2 months. The standard charging time should be of at least 12 hours.
- Replace the battery when the discharge time is less than 50% of specified after full charge. Check the battery connection or contact your local dealer to order a new battery.



**DANGER**

COMPONENTS INSIDE THE UPS ARE CONNECTED TO THE BATTERY EVEN WHEN THE UPS IS DISCONNECTED FROM THE MAINS POWER SUPPLY.



**WARNING**



**DANGER**

DISCONNECT THE BATTERIES BEFORE CARRYING OUT ANY KIND OF SERVICE AND/OR MAINTENANCE. VERIFY THAT NO CURRENT IS PRESENT AND NO HAZARDOUS VOLTAGE EXISTS IN THE CAPACITOR OR BUS CAPACITOR TERMINALS.



**WARNING**



**DANGER**

THE BATTERY CIRCUIT IS NOT ISOLATED FROM THE INPUT VOLTAGE. HAZARDOUS VOLTAGES MAY OCCUR BETWEEN THE BATTERY TERMINALS AND THE GROUND. VERIFY THAT NO VOLTAGE IS PRESENT BEFORE SERVICING.



**WARNING**



**DANGER**



**WARNING**

**A BATTERY CAN PRESENT A RISK OF ELECTRICAL SHOCK AND HIGH SHORT CIRCUIT CURRENT. THE FOLLOWING PRECAUTIONS MUST BE OBSERVED WHEN WORKING ON BATTERIES:**

- REMOVE WATCHES, RINGS OR OTHER METAL OBJECTS
- MAKE USE OF PROPER PPE (PERSONAL PROTECTION EQUIPMENT) AS PER LOCAL POLICIES AND RULES
  - WEAR FLAME/ARC RESISTANT WHOLE BODY CLOTHING
  - WEAR SUITABLE VOLTAGE RATED GLOVES
  - USE SAFETY DIELECTRIC FOOTWEAR
  - WEAR ARC FLASH FACE SHIELD
  - USE VOLTAGE RATED TOOLS
- DO NOT LAY TOOLS OR METAL PARTS ON TOP OF BATTERIES
- DISCONNECT THE CHARGING SOURCE PRIOR TO CONNECTING OR DISCONNECTING BATTERY TERMINALS.



**CAUTION**

REPLACE BATTERIES WITH THE SAME NUMBER AND SAME TYPE OF BATTERIES.



**CAUTION**

REPLACE FUSES ONLY BY DEVICES OF THE SAME TYPE AND OF THE SAME AMPERAGE TO AVOID FIRE HAZARDS.



## 2.1 Replacing internal batteries

To replace the internal batteries:

1. Remove the LCD box and the screws on the front panel.
2. Slide and pull the front panel to the left and remove it.
3. Disconnect the cable from the UPS and the battery pack.
4. Remove the right inner battery bracket.
5. Pull out the battery pack and place it on a flat surface.
6. Install the new battery pack.
7. Screw on the battery protection and reconnect the battery cable (A and B in Figure 1).
8. Re-install the front panel back to the UPS.

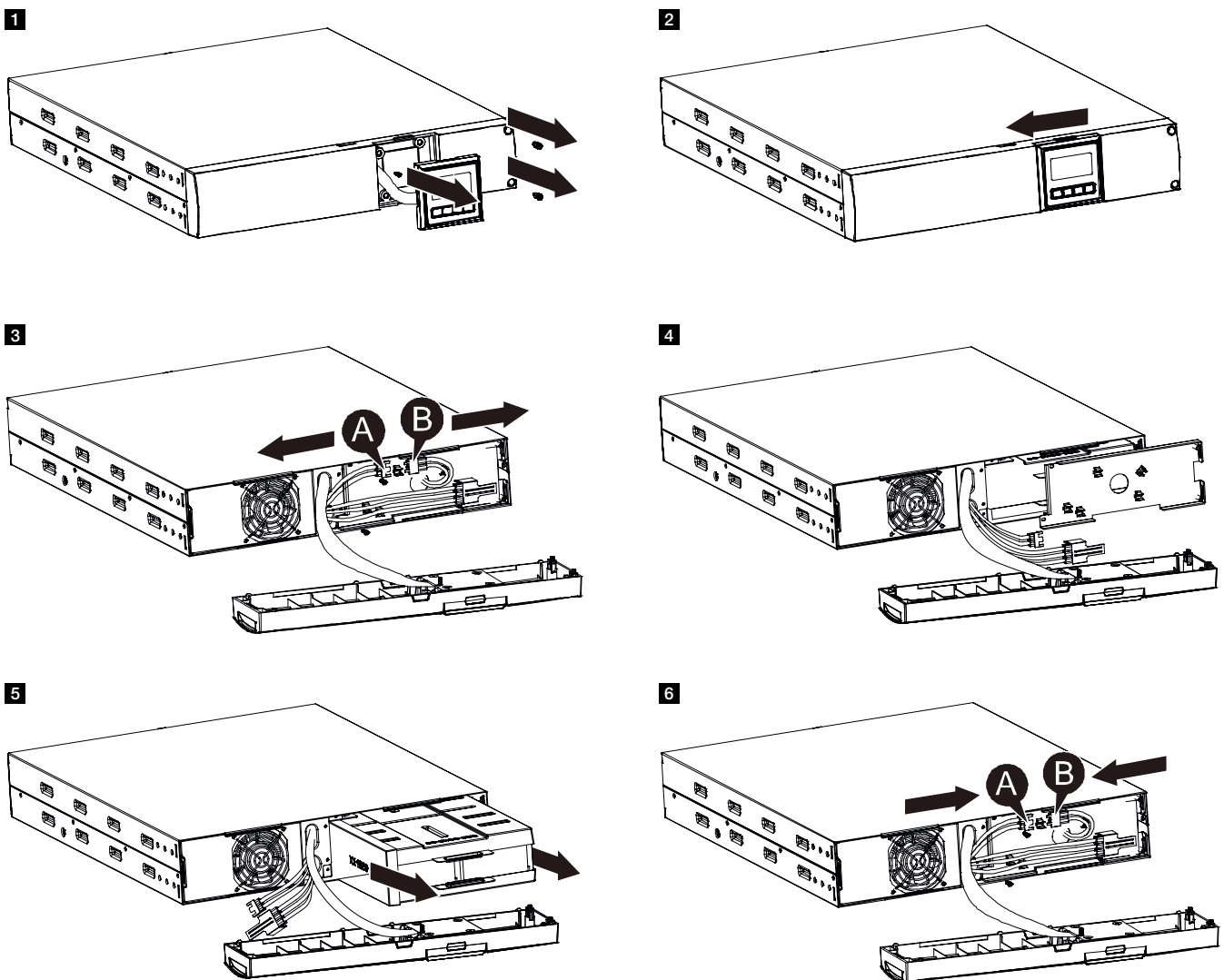

Figure 1: Replacing internal batteries

## 2.2 Testing new batteries

To perform a battery test:

1. Check that the batteries are fully charged. If this is not the case, connect the UPS to the mains power for at least 48 hours.
2. Transfer the UPS to Online or Eco Mode (High efficiency mode).
3. Clear out all alarms if existent.
4. Start the battery test by clicking **Start battery test** in the **Control menu**.



**NOTE**

THE LOAD SHOULD BE CONNECTED WHEN PERFORMING THE BATTERY TEST.

## 2.3 Battery recycling



**WARNING**

NEVER DISPOSE BATTERIES ON FIRE AS THEY MAY EXPLODE.



**WARNING**

DO NOT OPEN OR MUTILATE THE BATTERIES.



**WARNING**

RELEASED ELECTROLYTE IS HARMFUL TO THE SKIN AND EYES.

Follow your local laws and regulations to discard the UPS, battery module and batteries.



# 3 Installation

## 3.1 Delivery, transportation, positioning and storage

### 3.1.1 Receipt of the UPS and visual inspection

When receiving the UPS, carefully examine the packing container and the UPS for any signs of physical damage. In case of damage, notify the carrier immediately.

The packing container of the UPS protects it from mechanical and environmental damage. To increase the protection, the UPS is wrapped in a plastic sheet. Keep the packaging for later re-use.

### 3.1.2 Unpacking list

After examining the package, open the carton box and remove the accessories:

- 1 x user manual
- 4 x UPS support (feet)
- 1 x IEC C13-C14 cable
- 1 x AC cable (Schuko plug)
- 1 x USB cable
- 1 x 2 pin EPO connector
- 1 x 4 pin EPO connector
- 1 x monitoring software CD

Rack mounting accessories (full rack mounting kit to purchase separately):

- 2 x 90° rack mounting brackets
- 4 x M6 clip nuts
- 4 x M6 screws
- 8 x M4 screws

Examine the UPS for any signs of damage and ensure that the received UPS corresponds to the material indicated in the delivery note. Notify your carrier or supplier immediately in case of any damage.

### 3.1.3 Storage of the UPS

If you plan to store the UPS prior to use, keep the UPS in a dry, clean and cool storage room with an ambient temperature between (-15 °C to +60°C) and humidity of less than 95% non-condensing. If the packing container has been removed, protect the UPS from dust. Keep the UPS always in upright position and do not drop the equipment.

## 3.2 Site planning and positioning

### 3.2.1 Planning before the installation

Install the unit to a position where any danger to the UPS is minimized to ensure a long service life:

- Install the UPS indoors.
- Leave 25 cm of space on each side of the cabinet to enable cooling airflow and ensure that the circulation of air to the ventilation slits is not obstructed.
- Avoid excessively high temperature and excessive moisture.
- Make sure that the surface is solid and flat.

### 3.2.2 Positioning

PowerValue 11 RT can be mounted in a rack or installed as a standalone configuration.



**WARNING**

**WATER CONDENSING MAY OCCUR IF THE UPS IS UNPACKED IN A VERY LOW TEMPERATURE. IN THIS CASE IT IS NECESSARY TO WAIT UNTIL THE UPS IS FULLY DRIED INSIDE OUT BEFORE PROCEEDING INSTALLATION AND USE TO AVOID HAZARDS AND ELECTRIC SHOCK, WAIT UNTIL THE UPS IS FULLY DRY BOTH INSIDE AND OUTSIDE BEFORE INSTALLING.**

### 3.2.3 Rack mount installation

PowerValue 11 RT can be installed in a 19-inch rack. Both the UPS and the external battery enclosure are 2U in height. Note that you need a rack mounting kit (purchased separately) for this operation.

#### 3.2.3.1 Installing the UPS

To install the UPS:

1. Align the rack mounting ears on the side of the UPS and tighten the screws.
2. Assemble the rack rails with the rack-mounting kit.
3. Slide the UPS into the rack rail and lock it into the structure.
4. Tighten the screws and then proceed with wiring of the UPS.

If installing additional UPS units, repeat the steps above for each cabinet.

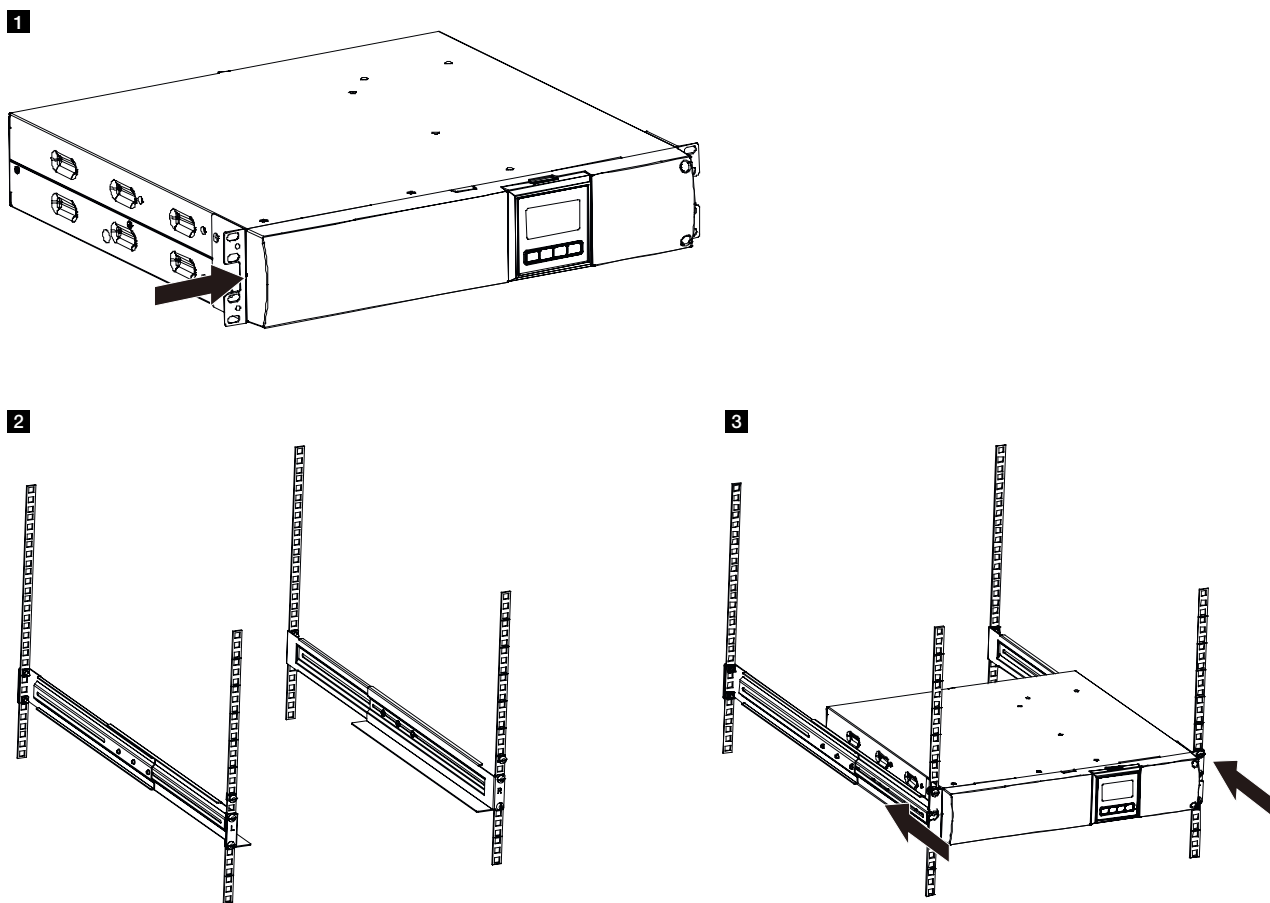

Figure 2: Installing the UPS

### 3.2.3.2 Installing the external battery enclosure

To install the external battery enclosure:

1. Install the external battery module into the rack above or below the UPS, for detailed instructions see chapter 3.2.3.
2. Connect the earth line from the UPS (port A) to the battery module (port B).
3. Remove the display box and remove the screws positioned in the front panel (in the back of the LCD box and on the right side of the panel). Remove the front panel and connect the battery terminal (A) from the UPS to the battery module terminal (B) as shown in figure 3. Remove the small cable entrance gate (C) on the side of the front panel to allow the outlet wire of the external battery enclosure to pass through the gate.
4. Reassemble the front panel.
5. After installing the UPS into the rack, connect the load to the UPS. Make sure the load equipment is turned off before plugging them into the output receptacle.

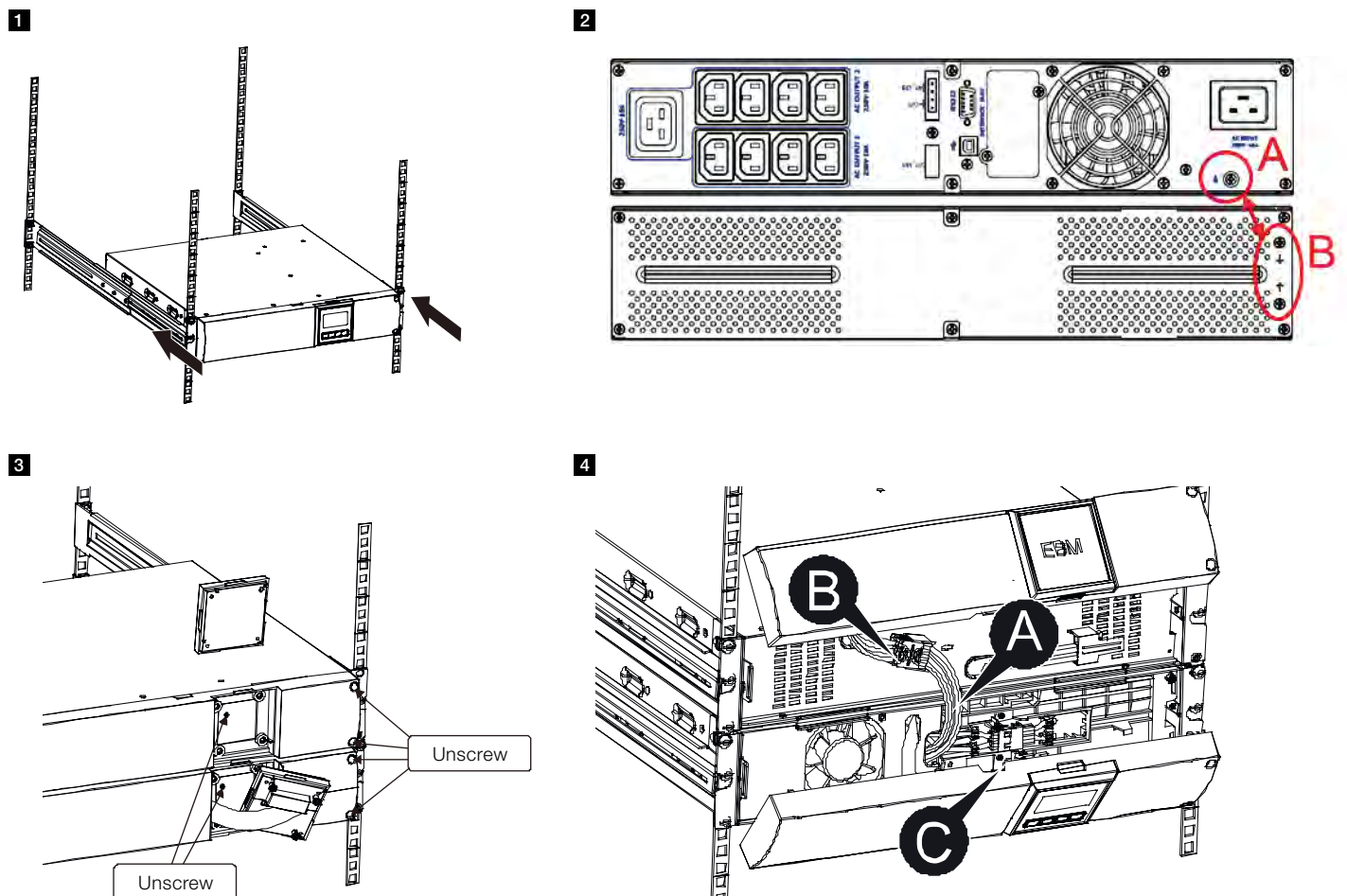

Figure 3: Installing the external battery enclosure

### 3.2.3.3 Installing multiple external battery enclosures

To install multiple external battery enclosures:

1. Remove the front panel and connect the battery terminal (A) from the UPS to the battery enclosure terminal (B) as shown in figure 4.
2. Connect the battery terminal (D) from the first battery enclosure to the battery terminal (E) in the second battery enclosure.
3. Remove the gates (C) on the side of the front panel to allow the outlet wire of the battery module to pass through the gate.
4. Reassemble the front panels.

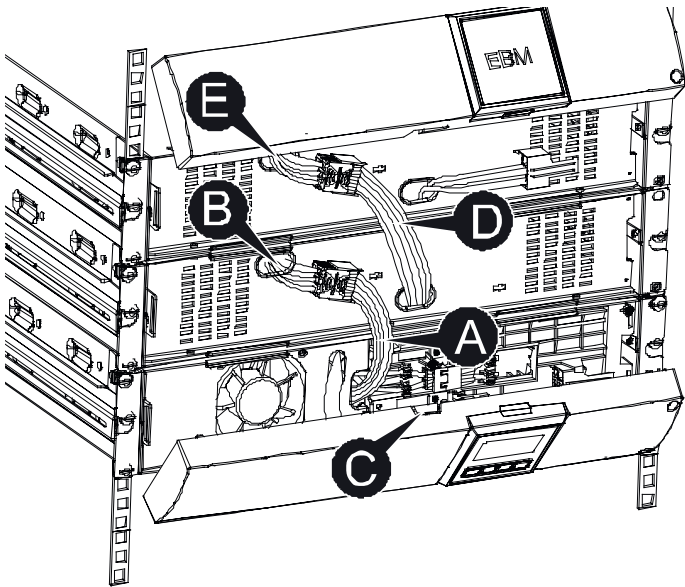

Figure 4: Installing multiple external battery enclosures



NOTE

UP TO FOUR EXTERNAL BATTERY ENCLOSURES CAN BE CONNECTED TO THE UPS IN THE SAME WAY AS SHOWN ABOVE.



NOTE

AFTER CONNECTING THE BATTERY ENCLOSURES, CONFIGURE THE NUMBER OF BATTERY MODULES IN THE CONTROL PANEL (FOR MORE INFORMATION, SECTION 4.4.2.6). SEE APPENDIX C FOR FURTHER DETAILS.

### 3.2.4 Standalone / Tower Installation

#### 3.2.4.1 Installing the UPS

To install the UPS in a vertical (tower) position on the UPS stands (feet):

1. Place the UPS in a vertical position with the front panel screws orientated upwards.
2. Place the two stands on a horizontal surface (see figure 5).
3. Place the UPS carefully on the UPS stands.
4. Pull out the LCD box. Rotate it 90° clockwise and then push it back into the front panel.

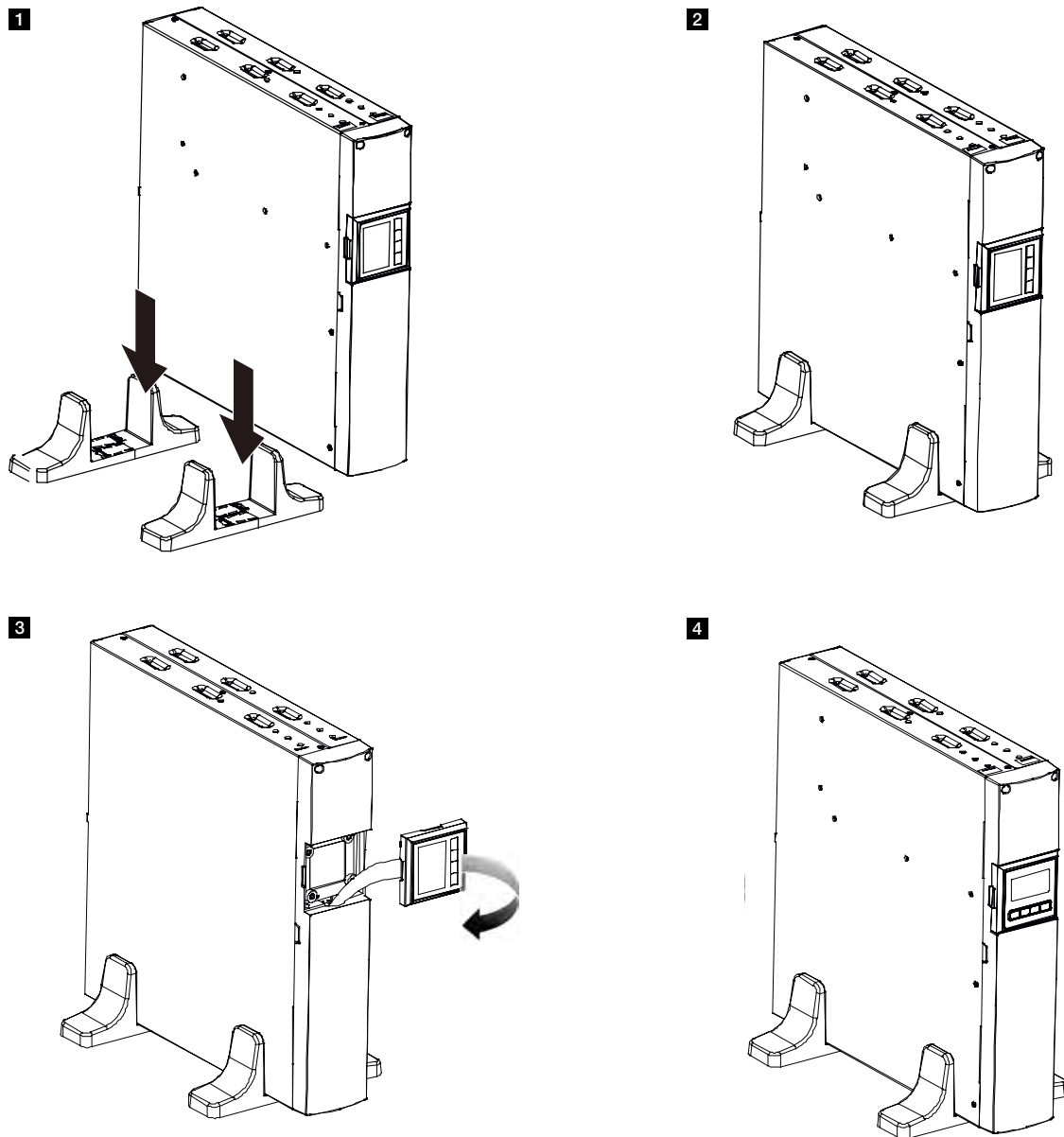

Figure 5: Installing the UPS in a vertical position



### 3.2.4.2 Installing the external battery enclosure

To install the external battery enclosure:

1. Pull out the LCD box and rotate it 90° clockwise. Then push the LCD box back into the front panel.
2. Place the UPS and the battery enclosure in a vertical position with the front panel screws upwards.
3. Place the two stands (feet) towards the end of the units (see figure 6).
4. Place the UPS and the battery enclosure carefully on the stands and tighten the screws on the top of the units.
5. Connect the earth line from UPS (port A) to the battery module (port B)
6. Remove the front panel and connect the battery terminal (A) from the UPS to the battery module terminal (B) as shown in Figure 6. Remove the small cable entrance gate (C) on the side of the front panel to allow the outlet wire of the external battery enclosure to pass through the gate.

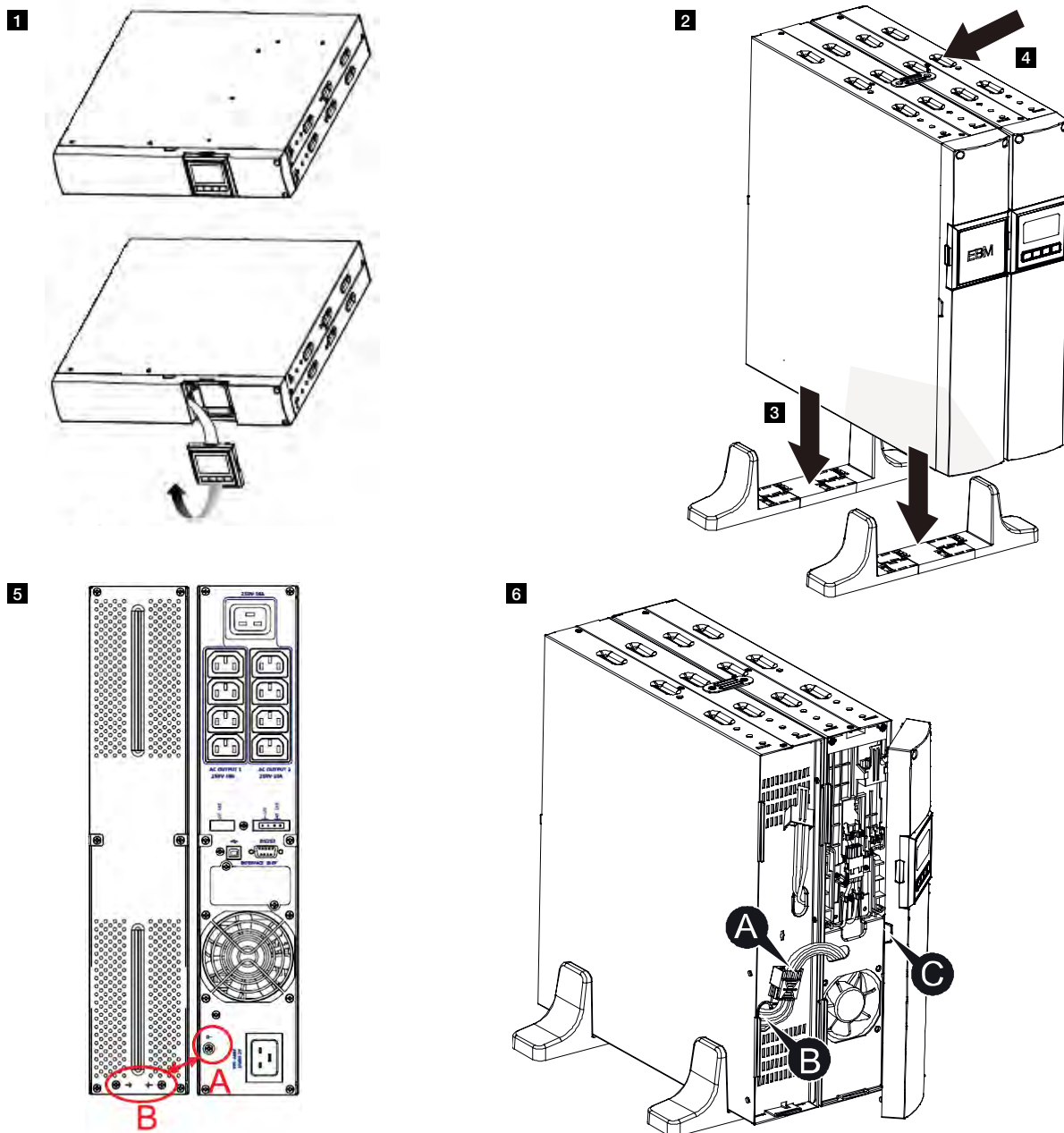

Figure 6: Installing the external battery enclosure in a vertical position

### 3.2.4.3 Installing multiple external battery enclosures

To install multiple external battery enclosures:

1. Connect the earth line between the UPS and the first battery enclosure. Then connect the earth line between the first battery enclosure and the second battery enclosure.
2. Remove the front panel and connect the battery terminal (A) from the UPS to the battery enclosure terminal (B).
3. Connect the battery terminal (D) of the first battery enclosure to the battery terminal (E) of the second battery enclosure. Remove the small gates (C) on the side of the front panel to allow the outlet wire of the battery enclosure to pass through the gates.
4. Reassemble the front panel.

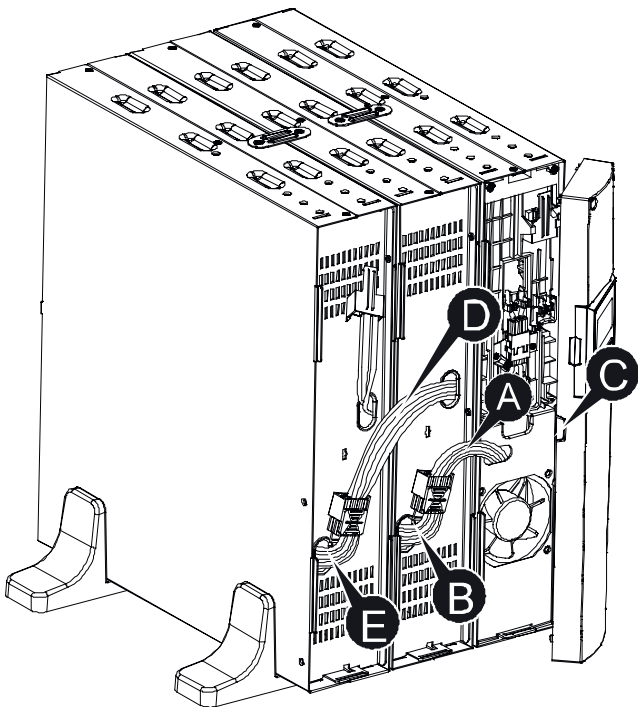

Figure 7: Installing multiple external battery enclosures



NOTE

UP TO FOUR EXTERNAL BATTERY ENCLOSURES CAN BE CONNECTED TO THE UPS IN THE SAME WAY AS SHOWN ABOVE.



NOTE

AFTER CONNECTING THE BATTERY ENCLOSURES, CONFIGURE THE NUMBER OF BATTERY MODULES IN THE CONTROL PANEL (FOR MORE INFORMATION, SEE 4.4.2.6). SEE APPENDIX C FOR FURTHER DETAILS.

### 3.3 General characteristics

#### 3.3.1 Front panel

Figure 8 shows the front panel of the UPS.

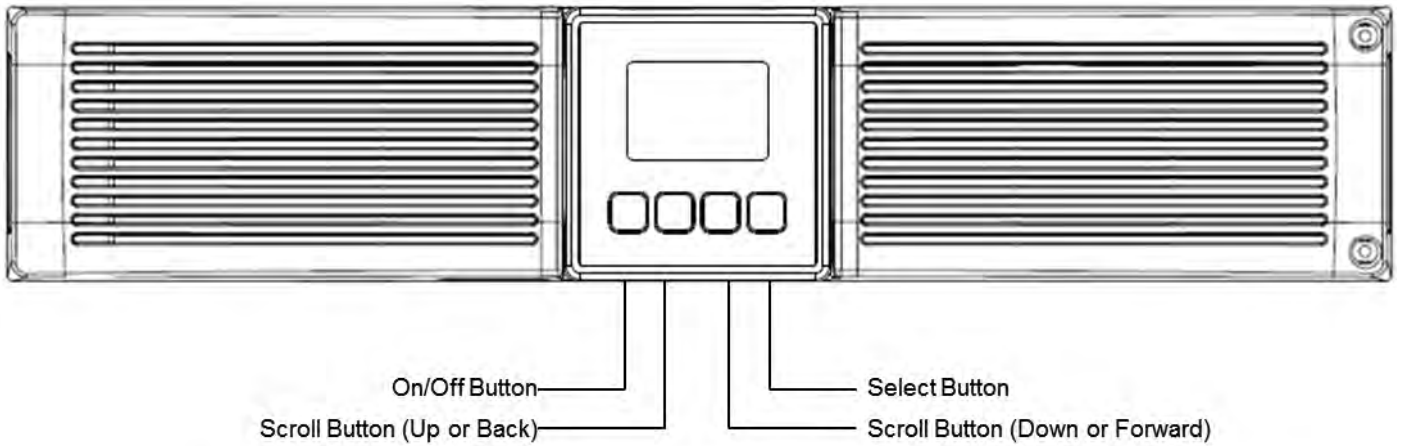

Figure 8: UPS front panel

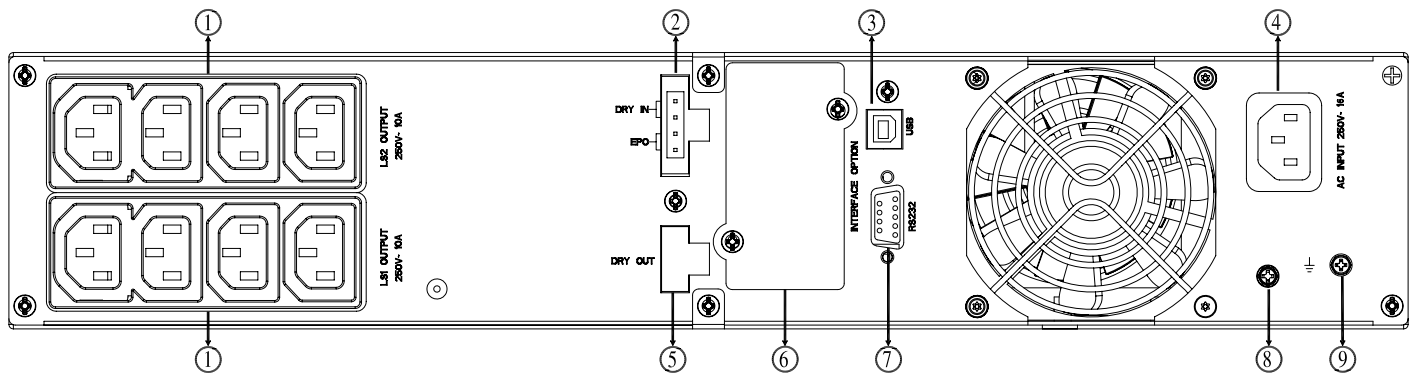

Figure 9: Rear view of PowerValue 11 RT 1 kVA B, 1 kVA S and 2 kVA B

1	AC output
2	EPO / Dry contact input port
3	USB port
4	AC input
5	Dry contact output port
6	SNMP/ AS400 slot
7	RS232
8	HI-POT screw
9	GND contact

Table 2: PowerValue 11 RT 1 kVA B, 1 kVA S and 2 kVA B connectors

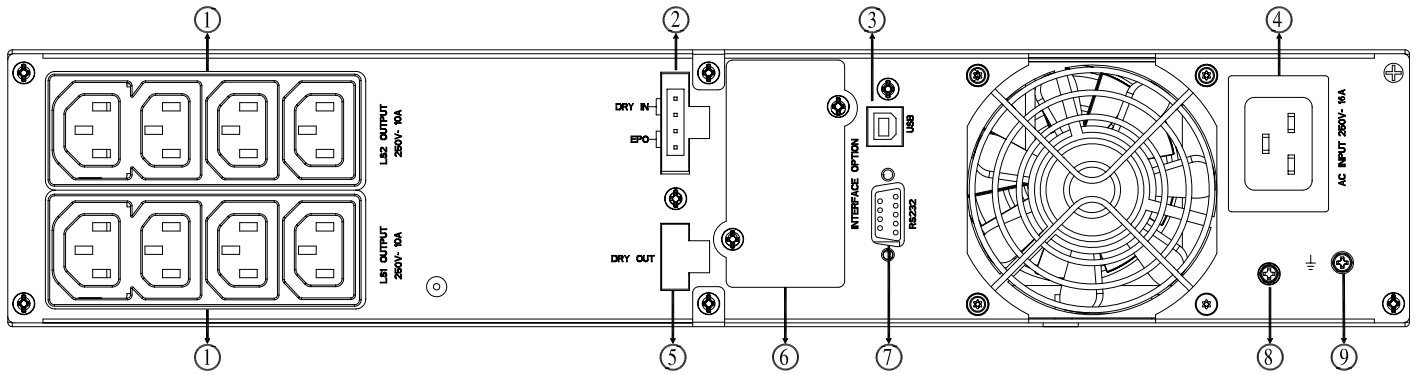

Figure 10: Rear view of PowerValue 11 RT 2 kVA S

1	AC output
2	EPO / Dry contact input port
3	USB port
4	AC input
5	Dry contact output port
6	SNMP/ AS400 slot
7	RS232
8	HI-POT screw
9	GND contact

Table 3: PowerValue 11 RT 2 kVA S connectors

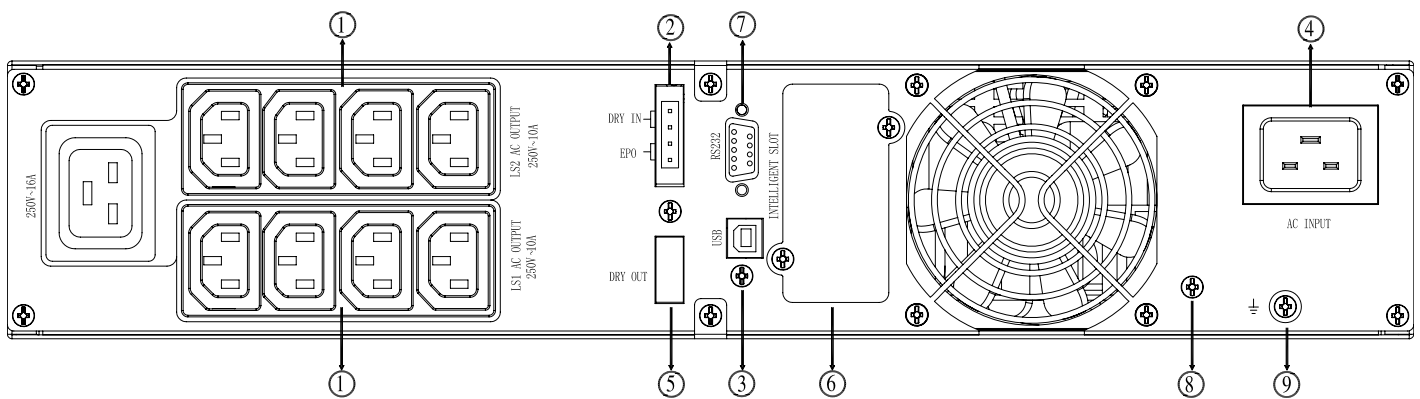

Figure 11: Rear view of PowerValue 11 RT 3 kVA B

1	AC output
2	EPO / Dry contact input port
3	USB port
4	AC input
5	Dry contact output port
6	SNMP/ AS400 slot
7	RS232
8	HI-POT screw
9	GND contact

Table 4: PowerValue 11 RT 3 kVA B connectors

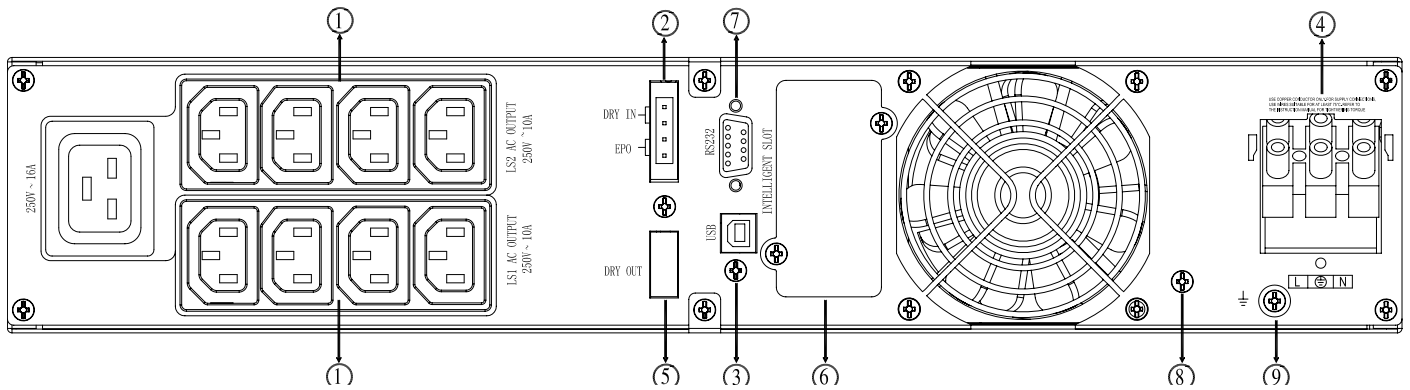
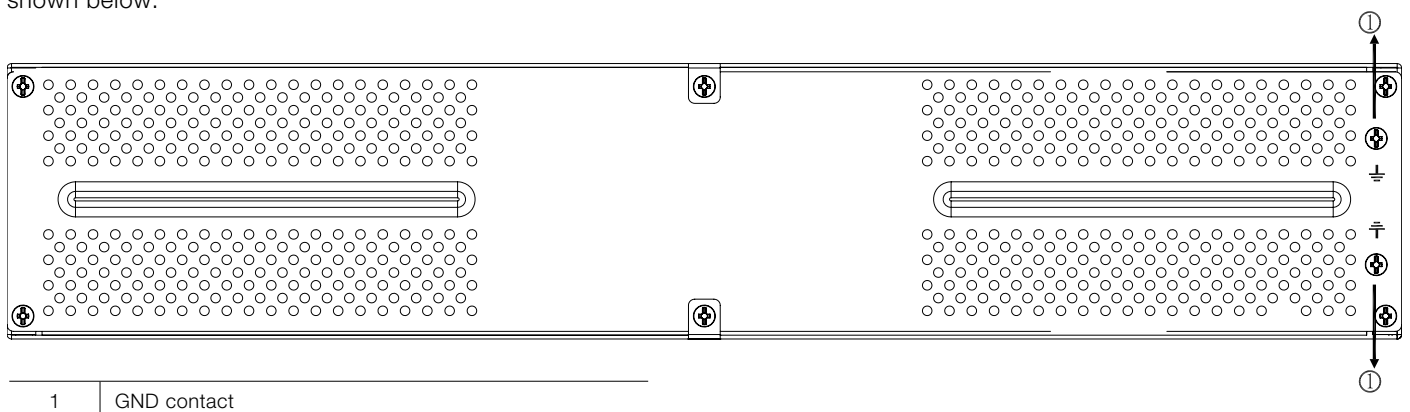

Figure 12: Rear view of PowerValue 11 RT 3 kVA S

1	AC output
2	EPO / Dry contact input port
3	USB port
4	AC input
5	Dry contact output port
6	SNMP/ AS400 slot
7	RS232
8	HI-POT screw
9	GND contact

Table 5: PowerValue 11 RT 3 kVA S connectors

The External Battery Enclosure rear panel's description is shown below:



1	GND contact
---	-------------

Figure 13: Rear view of 36V, 48V and 72V Battery Enclosures

## 3.4 Electrical installation

### 3.4.1 Commissioning

The commissioning of the UPS includes the connection of the UPS and batteries, the verification of the electrical installation and operating environment of the UPS, and the controlled start-up and testing of the UPS and customer training.

  
**CAUTION** DO NOT OPERATE IN CASE OF PRESENCE OF WATER OR MOISTURE.

  
**DANGER**

  
**WARNING**

WHEN OPENING OR REMOVING THE UPS-COVERS YOU ARE EXPOSED TO DANGEROUS VOLTAGES.

### 3.4.2 Connections

Before installing the electrical wiring, check the nominal amperage of your incoming feeder.

#### 3.4.2.1 Input

  
**NOTE**

IF THE UPS IS CONNECTED THROUGH THE POWER CORDS SUPPLIED WITH THE UNIT, USE THE APPROPRIATE INPUT CONNECTORS WITH PROTECTION AGAINST ELECTRIC CURRENT. REFER TO THE TECHNICAL SPECIFICATIONS DOCUMENT FOR MORE INFORMATION.

THE UPS SYSTEM DOES NOT HAVE AN INPUT BREAKER IN THE STANDARD CABINET. WHEN INSTALLING THE UPS, CONNECT THE EXTERNAL BREAKERS AND PROTECTIVE COMPONENTS IN THE INPUT TERMINALS. IT IS RECOMMENDED TO SELECT NFB (NON-FUSED BREAKERS) INSTEAD OF THE TRADITIONAL COMBINATION KIT INCLUDING BREAKER AND FUSE.

  
**NOTE**

REFER TO THE TECHNICAL SPECIFICATIONS DOCUMENT FOR MORE INFORMATION ON SELECTING BREAKERS.

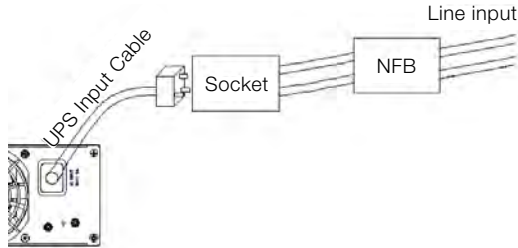

11RT 3 kVA S ONLY:  
USE APPROPRIATE TOOLS AND TERMINAL SPLICES TO GUARANTEE A RELIABLE CONTACT BETWEEN THE AC INPUT WIRES AND THE TERMINAL BLOCKS. REFER TO THE TECHNICAL SPECIFICATIONS DOCUMENTS FOR MORE INFORMATION ON RECOMMENDED CABLE CROSS SECTION.

  
**NOTE**



#### 3.4.2.2 Output

The output connections of the UPS are made through the IEC sockets in the back of the units. Plug the load power cord to the output sockets to complete the connection.

  
**CAUTION**

DO NOT CONNECT EQUIPMENT THAT COULD OVERLOAD THE UPS SYSTEM (FOR EXAMPLE LASER PRINTERS).

### 3.5 Emergency power off (EPO)

The EPO connector can be used to block the output of the UPS in case of an emergency. The EPO connector can be configured as Normally closed (NC) or Normally opened (NO) through the USB or RS232 port.

By default, the EPO connector is Normally closed (NC) by a jumper in the rear panel. If the jumper is removed, the UPS output will not supply energy to the load until the EPO status is changed.

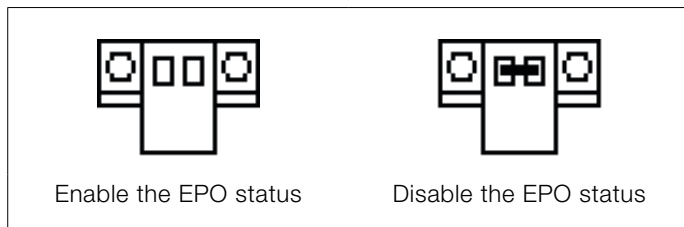

Figure 14: EPO connector

To return to normal status, the EPO connector must be closed. Enter the LCD menu to clear the EPO status (for more information, see Chapter 4.4.2.4). The UPS alarm is cleared and bypass mode is recovered. Set the UPS to inverter mode manually, for more information, see chapter 4.4.4.1.

To inverse the polarity of the connector in the LCD menu, see Chapter 4.4.2.6. Contact your local ABB for further information before modifying the settings.

### 3.6 Installation checklist

Before installing the UPS check that:

- All packing materials and restraints have been removed from all modules.
- Each module in the UPS system is placed in the installed location.
- All conduits and cables are properly routed to the UPS and auxiliary enclosures.
- All power cables are correctly sized and terminated.
- A ground conductor is correctly installed.
- Battery enclosure is installed.
- Air conditioning equipment is installed and operating correctly.
- The area around the installed UPS system is clean and dust-free.
- Adequate workspace exists around the UPS and other cabinets.
- Adequate lighting is provided around all UPS equipment.
- Any optional accessories are mounted in their installed location and correctly wired.
- Summary alarms and/or building alarms are wired appropriately.
- Authorized service personnel has performed start-up and operational checks.
- All network connections are completed.

# 4 Operation

This chapter describes how the UPS is operated through the LCD display.

The user can:

- Operate the LCD display
- Start up and shut down the UPS (excluding the commissioning start up)
- Operate additional SNMP adapters and their software

## 4.1 Control Panel

The user-friendly control panel has two parts:

- selection keys
- power management LCD display (PMD)

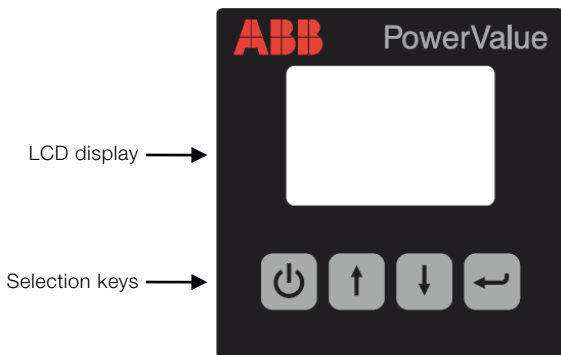

Figure 15: Control panel

### 4.1.1 Selection Keys

Table 6 shows the selection keys of the UPS.





Button	Function	Illustration
	Power on/off	Turn the UPS on and off or change operating mode.
	Scroll up	Enter/exit the menus and scroll across the screens.
	Scroll down	Scroll down the menu.
	Select / Edit	Select and confirm settings.

Table 6: UPS selection keys

For more information on operating the UPS, see Chapter 4.2.



### 4.1.2 LCD display

The LCD display shows an overview of the status of the UPS:

- Input
- Output
- Battery
- load parameters
- working mode
- settings on voltage
- frequency
- bypass presence.

The display has two main backlight colors. During normal operation the display has a blue background with white text. In case of a critical alarm, the backlight color changes to orange with dark text.

A buzzer indicates UPS status. Table 7 lists the buzzer status meanings.

UPS condition	Buzzer status
Active fault	Continuous
Active warning	Beep every second
Battery	UPS on battery: Beep every 4 seconds Low battery: buzzer beeps every second
Bypass	Beep every 2 minutes
Overload	Beep twice every second

Table 7: Definition of alarms

When powering on, the LCD display shows the UPS status. The UPS will also return to this default screen when no buttons have been pressed for 15 minutes.

The status screen shows the following information:

- Status summary, including operating mode and load information
- Alarm status, if present (including fault and warning information)
- Battery and charger status (including battery voltage, charge level and charger status)
- Current runtime information

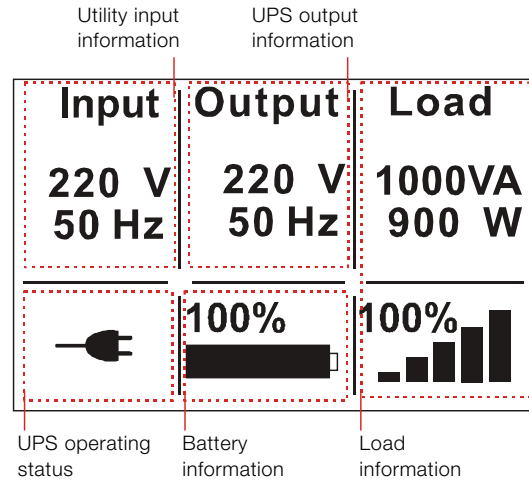

Figure 16: The default LCD display

## 4.2 Operating Mode

Symbols indicate the status and the operating mode of the UPS. Symbols appear in the position shown in Figure 17.

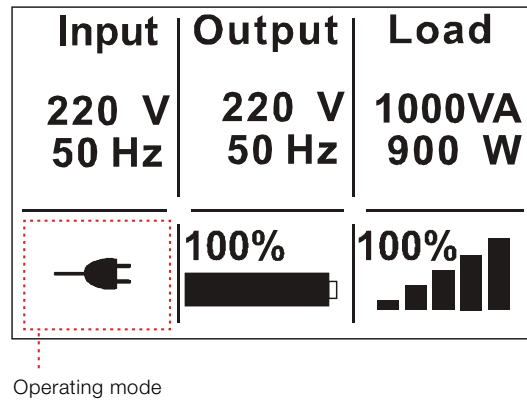

Figure 17: Operating mode











Status	Symbol	Description
Online-mode		UPS is running through the inverter (online-mode)
Battery-mode		UPS is running on battery. The alarm buzzer sounds every 4 seconds.
Bypass-mode		The power used by the load is supplied from the mains power via an internal filter. Note that if there is a power failure and the UPS is on bypass, it will not transfer back to mains or to battery-mode. In bypass-mode the alarm buzzer will sound every 2 minutes.
Stand-by-mode		UPS is running in bypass but there is no power in the output.
ECO-mode		After the UPS is turned on, the power used by the load is supplied from the mains via an internal filter if its power is in an acceptable range. This guarantees higher efficiency of the UPS. In case of a mains failure, the UPS transfers to Online-mode or Battery-mode and the load is supplied continuously. <b>Note:</b> ECO-mode can be enabled through the LCD settings or through the monitoring software. <b>Warning:</b> The transfer time of UPS output from ECO-mode to battery-mode is 10ms and not recommended for sensitive loads
Converter-mode		In converter-mode, the UPS runs with fixed output frequency (50Hz or 60Hz). In case of a mains failure, the UPS transfers to battery-mode and the load is supplied continuously. <b>Note:</b> - Converter-mode function can be enabled through the LCD settings or the monitoring software. - The load is de-rated to 70% in converter-mode.
Warning		Warnings indicate abnormal situations that do not stop the UPS from working. The UPS continues running but the user should perform corrective actions. For more information, see Chapter 6.
Fault		In case of failure, the UPS may disconnect the load or transfer to bypass depending on the cause of the failure. The UPS alarm sounds a continuous signal and the backlight of the UPS will turn red. For more information, see Chapter 6.
Overload		When the UPS is on overload, an alarm sounds twice every second. Disconnect unnecessary loads one by one to decrease the load. The load should be lower than 90% of its nominal power capacity in order to stop alarming.
Battery test		UPS is performing a battery test.
Battery disconnected		The battery is disconnected or defective. The UPS alarm sounds.

Table 8: Symbols in operating mode

## 4.3 UPS start-up and shutdown



**NOTE**

**THE FIRST TIME THE UPS IS STARTED-UP, THE UTILITY MUST BE CONNECTED. THIS IS TO PREVENT TURNING ON THE UPS BY MISTAKE DURING TRANSPORTATION.**



**CAUTION**

**SWITCH OFF THE CONNECTED LOADS BEFORE TURNING ON THE UPS. THEN SWITCH ON THE LOADS ONE BY ONE AFTER THE UPS IS TURNED ON. SWITCH OFF ALL OF THE CONNECTED LOADS BEFORE TURNING OFF THE UPS.**

### 4.3.1 UPS start-up

To start up the UPS with mains supply:

1. Check that all cables are connected correctly and well-fixed mechanically.
2. Connect the UPS to the power supply.
3. Keep the power-on button pressed for longer than 1 second. The alarm buzzer will sound for 1 second and the UPS will start up.
4. After a few seconds, the UPS goes to online-mode. If the mains power is abnormal, the UPS will transfer to battery-mode without interruption in the output of the UPS.

To start up the UPS without mains supply (cold start):

1. Check that all cables are connected correctly and well-fixed mechanically.
2. Press the power-on button. The UPS will perform a self-test and display the status screen.
3. Keep the power-on button pressed for longer than 1 second. The alarm buzzer sounds and the UPS will start up.
4. After a few seconds, the UPS transfers to battery-mode. When the UPS is supplied with power from the mains, the UPS transfers to online-mode without interruption in the output of the UPS.

### 4.3.2 UPS shutdown

To shut down the UPS with mains supply:

1. If the UPS is working on bypass-mode, go to step 3.
2. If the UPS is on online-mode, keep the power-on button pressed for more than 3 seconds. The alarm buzzer will sound and the UPS will transfer to bypass-mode.



**NOTE**

**THE OUTPUT IS STILL ENERGIZED.**

3. Disconnect the mains power supply. The display will shut down and the output voltage will be removed from the UPS output terminal.
4. In case bypass has been disabled through the Settings menu, keep the power-on button pressed for more than 3 seconds to shut down the UPS. The unit will transfer from online to stand-by mode. Disconnect the input power cable and the display will shut down.

To shut down the UPS without mains supply:

1. To power off the UPS, keep the power on/off button pressed for more than 3 seconds. The alarm buzzer will sound for 3 seconds and the output power will be immediately cut-off.
2. The display will shut down and the output voltage will be removed from the UPS output terminal.

## 4.4 UPS operation

The LCD display shows information on the status of the UPS, measurements, events and general information on the UPS. This chapter describes how to navigate through the display and how to adjust the user's settings.

### 4.4.1 Changing the operating-mode

To change the operating-mode, the power-on button is used as follows:

- From online-mode to bypass-mode: Press the power-on button for 3 seconds.
- From bypass-mode to online-mode: Press the power-on button for 3 seconds.
- From bypass-mode to battery: Disconnect the power supply cable
- From battery-mode to online-mode: Connect the power supply to the UPS and it will transfer automatically to online-mode.



**NOTE**

IF BYPASS IS DISABLED IN THE SETTINGS MENU AFTER PRESSING THE POWER-ON BUTTON FOR 3 SECONDS, THE UPS GOES FROM ONLINE MODE TO STAND-BY MODE.

### 4.4.2 Navigation

Use the scroll buttons to navigate through the UPS screens. From the main screen (UPS status screen), press or for information on alarm and battery.

From the main screen, keep pressed for longer than 1 second to enter the main menu.

The main menu has the following submenus:

- UPS status
- event log
- measurements
- control
- identification
- settings.

Figure 18 shows how to navigate through the menus and submenus.

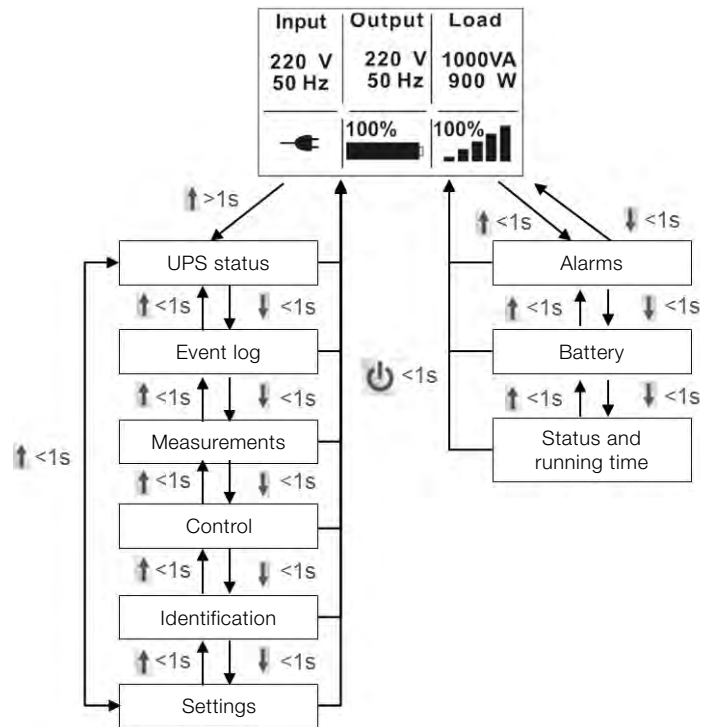

Figure 18: Main menu tree

#### 4.4.2.1 UPS Status

The UPS status menu contains general information on the status of the UPS.

#### 4.4.2.2 Event log

To enter the event log menu, press . The last 50 events, alarms and faults occurred in the UPS are displayed. The alarms are indicated by the corresponding event code and operating time of UPS. To navigate through the events and alarms, press or .

#### 4.4.2.3 Measurements

To enter the measurements menu, press . The following measurements are displayed:

- Output power [W]
- Output power [VA]
- Output current [A]
- Load percentage [%]
- Output voltage [V]
- Output frequency [Hz]
- Input voltage [V]
- Input frequency [Hz]
- Battery voltage [V]
- Battery capacity [%]
- DC bus voltage [V]
- Temperature [oC]

To navigate through the measurements, press or .

#### 4.4.2.4 Control

Using the Control menu, you can control the operations shown in table 9.

Control	Description	Possible values	Default values
Buzzer mute	Mute the UPS sound	No/Yes	No
Start battery test		Schedule No/Yes	No
Load segments		Seg1 and seg 2: on/off	On/On
Clear EPO status	Remove UPS from emergency power off status	No/Yes	No
Reset fault state	Reset warning, alarming status and buzzer	No/Yes	No
Clear event log	Reset all the events from the log file	No/Yes	No
Restore factory settings	Recover all settings in the LCD menu and the EPO polarity and locks the DC start-up (can be executed only when UPS is in bypass mode)	No/Yes	No

Table 9: UPS control menu

To modify the parameters, press . Then scroll up or down to modify the parameters. To confirm the selection, keep pressed for longer than 1 second.

Figure 19 shows an overview on how to navigate the control menu.

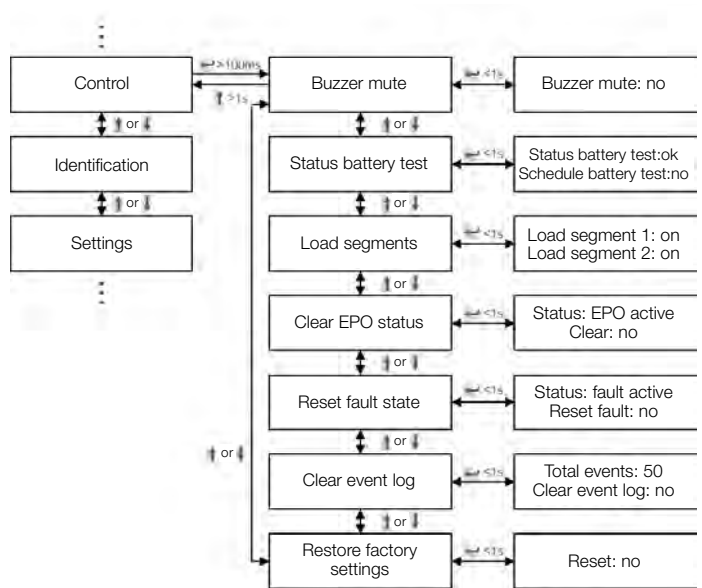



Figure 19: Control menu tree

Examples:

- Clear EPO status: Once the EPO status is enabled, the UPS output is cut-off. To return to normal status, the EPO connector must first be closed. Enter this menu to clear the status of EPO. The UPS alarm will stop and it will recover to bypass-mode. Note that the UPS needs to be turned on manually.



**NOTE** MAKE SURE THE EPO SIGNAL IS INACTIVE OR THE LCD WILL SHOW THAT THE EPO ACTIVE STATUS COULD NOT BE CLEARED.

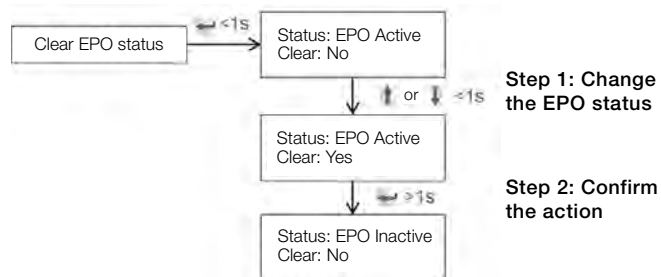



Figure 20: Clear EPO status

- Reset fault status: When a failure occurs, the UPS goes to fault-mode and the buzzer alarm sounds. After checking the reason of the failure and taking the appropriate corrective actions, enter this menu to reset the error status and recover the normal status. The UPS alarm will stop and it will recover to bypass-mode.
- Restore factory settings: All factory settings are recovered. Note that this operation can only be executed when the UPS is in bypass-mode.

#### 4.4.2.5 Identification

Press  on the Identification menu to navigate through its data. The identification information includes UPS serial number, firmware serial number and model type. Keep  pressed for longer than 1 second to return to the last main menu.

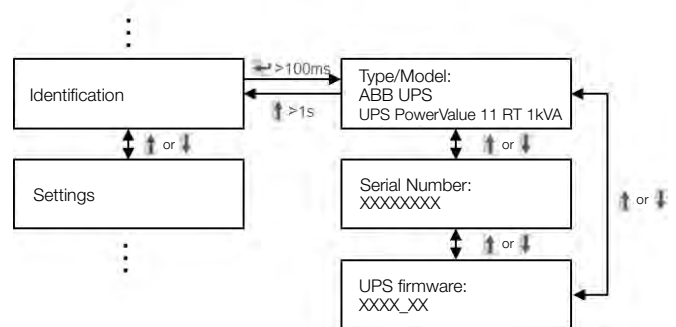





Figure 21: Identification menu tree

#### 4.4.2.6 Settings

Some settings in the Settings menu impact the performance of the UPS and others enable and disable functions within the UPS. Failures and reduced protection can occur if the equipment is not set in an adequate way.



**NOTE** MOST SETTINGS SHOULD BE DONE ONLY WHEN THE UPS IN BYPASS-MODE.

Press  in the Settings menu to enter the sub-menus. To modify a parameter, press  and scroll up or down. To confirm the selection keep  pressed for longer than 1 second.

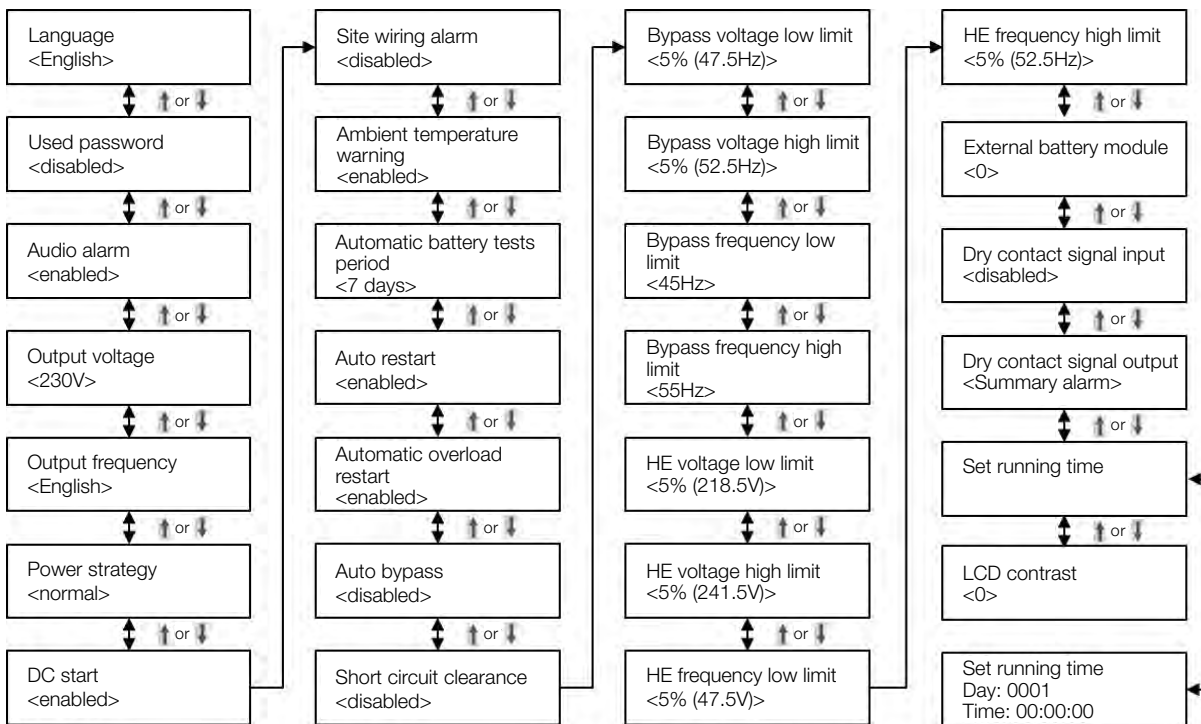





Figure 22: Settings menu tree

If the user password is enabled, enter the password **4314** by pressing the buttons ,  and . The password is used mainly to protect against unwanted modifications in the Settings menu.

The available operations are listed in Table 10.

Submenu item	Description	Optional Values	Default value
Language	Select menu language	English / Chinese	English
User password	Protects against settings modifications	enabled/disabled	disabled
Audio alarm	Enable/disable alarm sounds	enabled/disabled	enabled
Rated output voltage	Define local rated output voltage	208/220/230/240V	230V
Output frequency	Define local rated output frequency	autosensing/50/60Hz	autosensing
Power strategy**	Define the UPS running mode as normal, ECO-mode (or HE high efficiency) and converter mode	normal/high efficiency (ECO-mode)/converter	normal
DC start (Cold start)	Start the UPS from the batteries (without mains power)	enabled/disabled	enabled
Site wiring fault alarm	Phase and neutral cables are connected in reversed positions.	enabled/disabled	disabled
Ambient temperature warning	Temperature is over the limit supported by the UPS	enabled/disabled	enabled
Automatic battery tests period	Define the frequency of the battery tests	0-31 days	7 days
Auto restart	After UPS shuts down (low battery capacity), the UPS restarts automatically when mains power is recovered.	enabled/disabled	enabled
Automatic overload restart	The UPS is automatically restarted if it shut downs due to overload	enabled/disabled	enabled
Auto bypass	Automatic bypass can be disabled for countries where the power supply is very unstable. UPS runs only online or on battery.	enabled/disabled	enabled
Short circuit clearance	- When enabled, short circuit will last for 4s before cutting off the output. If short circuit is removed during this time, the UPS will continue to run normally. - When disabled, short circuit will only last for 100ms before UPS output is cut off.	enabled/disabled	disabled
Bypass voltage low limit	When the voltage in the bypass is below this limit, the UPS changes running mode.	120~215V	184V
Bypass voltage high limit	When the voltage in the bypass is above this limit, the UPS changes running mode.	245~276V	264V
Bypass frequency low limit	When the frequency in the bypass is below this limit, the UPS changes running mode.	40~49.5 Hz	45 Hz
Bypass frequency high limit	When the frequency in the bypass is above this limit, the UPS changes running mode.	50.5~70 Hz	55 Hz
Eco-mode voltage low limit	When the voltage in the bypass is below this limit, the UPS changes running mode.	5%~10%	5%
Eco-mode voltage high limit	When the voltage in the bypass is above this limit, the UPS changes running mode.	5%~10%	5%
Eco-mode frequency low limit	When the frequency in the bypass is below this limit, the UPS changes running mode.	5%~10%	5%
Eco-mode frequency high limit	When the frequency in the bypass is above this limit, the UPS changes running mode.	5%~10%	5%
External battery modules***	Define the number of battery modules. If number is higher than 4, it should be configured through the monitoring software	0 - 9	0
Set running time	Set the UPS running time mainly used for test purposes	Day:hour:minute:second 0000:0000:00~9999:23:59:59	Running time
LCD contrast	Changes the light contrast in the LCD panel	-5~+5	0

\*\*Read Chapter 4.2, before using high efficiency (ECO-mode) or converter function.

\*\*\*Ensure that the actual battery quantity is equal to the settings in order not to damage the batteries (for more information, see appendix C).

Table 10: Settings menu



Example: Setting the rated output voltage value and setting running time (Figure 23)

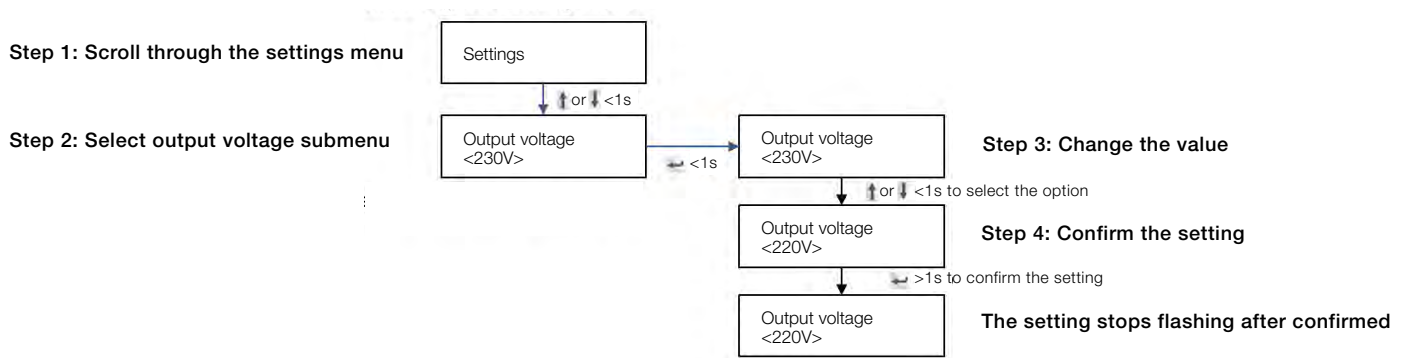

Figure 23: Setting rated output voltage value

# 5 Communication

A USB and an RS-232 port are available to enable the communication between the UPS and a remote computer/ station. Only one communication port can be active at a time and the priority is given to the USB port.

Once the communication cable is installed, the power management software can exchange information with the UPS. The software collects information from the UPS and indicates the status of the device, the power quality of the mains and the battery autonomy of the units.

In case of a power failure and a predicted shutdown of the UPS due to low battery autonomies, the monitoring system is capable of saving the data in the load and of initiating the shutdown of the equipment connected to the UPS.

## 5.1 RS-232 port

The UPS has an RS-232 port for UPS monitoring, control and firmware updates. To establish communication between the UPS and a computer, connect one end of the serial communication cable to the RS-232 port on the UPS and the other end to the RS-232 port of a computer.

The cable pins for the RS-232 communication port are described in Figure 24 and in table 11.

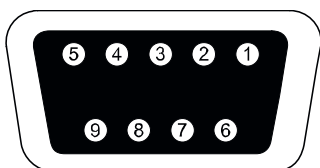

Figure 24: RS-232 Communication Port (DB-9 Connector)

Pin Number	Signal Name	Function	Direction from the UPS
1		Unused	Not applicable
2	Tx	Transmit to external device	Out
3	Rx	Receive from external device	In
4		Unused	Not applicable
5	GND	Signal common (tied to chassis)	Not applicable
6		Unused	Not applicable
7		Unused	Not applicable
8		Unused	Not applicable
9		Unused	Not applicable

Table 11: RS- 232 Port Pin Assignment

## 5.2 USB port

The UPS can communicate with USB-compliant computers. To establish communication between the UPS and a computer, connect the USB cable to the USB port on the UPS. Connect the other end of the cable to the USB port on a computer.

## 5.3 Dry contact ports

Remote alarm indication can be set up using the potential free (dry contact) ports positioned in the rear of the UPS. The 4-pole connector corresponds to the input contacts. Configure the signal input to control UPS On/Off/Maintain bypass statuses through the LCD setting menu or protocol command. The default input contact is "Disabled".

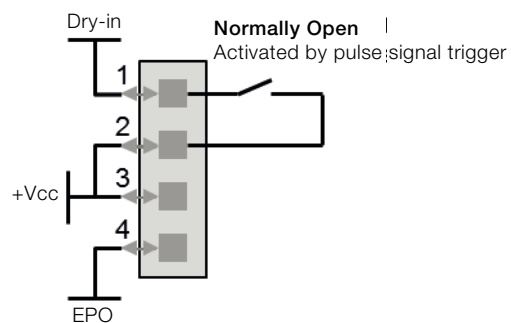

Figure 25: Input Dry contact schematic

Dry contact input signal	Description
Disable	Disable the function.
UPS On	One second pulse activate. If active, the UPS turns on if the UPS is not on inverter.
UPS off	One second pulse activate. If active, the UPS turns off if the UPS is on inverter.
Maintain bypass	One second pulse activate. If active, the UPS will transfer to bypass-mode. To recover to normal status, inactivate the signal and turn on the UPS manually.

Table 10: Dry contact input signal

The 2-pole connector corresponds to the output contacts. Configure the relay output through the LCD settings menu or protocol command, the default output contact corresponds to "Summary Alarm". The possible alarms are shown in table 11.

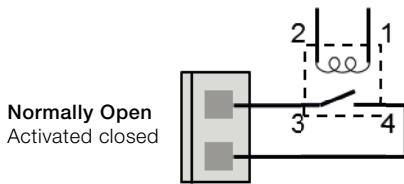

Figure 26: Output Dry Contact schematic

Dry contact output signal	Description
Summary alarm	Activated when any warning happens
On battery	Activated when the UPS operates on battery
Battery low	Activated if battery autonomy is low
UPS ok	Activated when the UPS has no alarms and no fault.
On bypass	Activated when the UPS has bypass output.

Table 11: Dry contact output signal

Note: The relay output contact must not be connected to any utility connected circuits. Reinforced insulation to the utility is required. The relay output contact has a maximum rating of 30Vac/1A and 60Vdc/2A normal values.

## 5.4 Network management card (optional)

PowerValue 11 RT is equipped with an intelligent slot for optional cards for remote management of the UPS through internet/intranet. Either of the following accessories can be installed in the intelligent slot:

- **SNMP Card** - SNMP, HTTP and monitoring capabilities through a Web browser interface.
- **AS400 Card** - AS400 card for AS400 communication protocol.

### 5.4.1 Installing a serial network management card (optional)

Each UPS has a communication slot for an optional Serial Network Management (SNMP) Card. After installing an SNMP card, an environmental monitoring probe can be connected to the UPS.



**THE UPS DOES NOT HAVE TO BE SHUT DOWN BEFORE INSTALLING A COMMUNICATION CARD.**

**NOTE**

To install the network management card:

1. Remove the two screws that protect the communication slot of the UPS.
2. Insert the SNMP card into the communication slot.
3. Screw the SNMP card onto the slot using the screws removed in step 1.

Compatible SNMP cards: CS141 Basic, CS141 ModBus, CS141 Advanced, WinPower

For more information on the SNMP Cards, see the SNMP user's manual. For more details about parameters available when using SNMP card with PowerValue 11 RT, see Appendix A and B.

### 5.4.2 Monitoring software

The UPS can be monitored using software. The software provides a remote and safe shutdown for multi-client systems in case of absence of power in the output of the UPS. Instructions on how to install the software are provided with the network management cards.

## 6 Troubleshooting

### 6.1 Fault identification and rectification

Alarm and events indicate warnings and notify of errors or potential failures in the system. The output of the UPS is not necessarily affected in case of an alarm but taking the correct actions may prevent loss of power to the load. If the UPS system does not operate correctly, attempt to solve the problem using the table below.

Always have the following information available when calling the after-sales service department:

1. Model number and serial number
2. Date on which the problem occurred
3. LCD/LED display information and buzzer alarm status
4. Mains power condition, load type and capacity, environment temperature and ventilation condition
5. Information on external battery pack (battery capacity, quantity)

Problem	Possible cause	Remedy
No indication, no warning tone even though system is connected to mains power supply	No input voltage	Check building wiring socket outlet and input cable.
Emergency supply period shorter than nominal value	Batteries not fully charged / batteries with defect	Charge the batteries for at least 5 - 8 hours and then check capacity. If the problem persists, consult your supplier.
Fan fail Alarm Code: 84	Fan abnormal	Check if the fan is running
Battery over voltage Alarm Code:16	Battery is overcharged	Stop charging to battery automatically, and after the battery voltage is normal and the mains is normal, charge automatically again.
Battery low Alarm Code:12	Battery voltage is low	If audible alarm sounds every second, the battery is almost empty.
Charge fail Alarm Code:15	The charge is broken	Notify dealer.
Inverter temperature high Alarm Code:86	Inside temperature of the UPS is too high	Check the ventilation of the UPS, check the ambient temperature.
Ambient temperature high Alarm Code:82	The ambient temperature is too high	Check the environment ventilation.
Battery open Alarm Code:11	Battery pack is not connected correctly	Check if the battery bank is connected to the UPS. Check if the battery breaker is turned on.
Service Battery Alarm Code:13	Battery may need to be replaced	Consult dealer
Overload Alarm Code: 41/42/43	Overload	Check the loads and remove some non-critical loads. Check whether some loads have failures.
Site fail Alarm Code:04	Phase and neutral conductor at input of UPS system are reversed	Rotate mains power socket by 180° or connect UPS system.
EPO active Alarm Code:71	EPO function is enabled	Turn off the EPO switch.
Bus fault (Low / high / Unbalance / Soft start) Alarm Code:22/21/23/25	UPS internal fault	Consult your supplier
Inverter fault (Low/high/soft start) Alarm Code:33/32/34	UPS internal fault	Consult your supplier
Over temperature fault Alarm Code:81	Over temperature	Check the ventilation of the UPS, check the ambient temperature and ventilation.
NTC open Alarm Code:87	UPS internal fault	Consult your supplier
Inverter short Alarm Code:31	Output short circuit	Remove all the loads. Turn off the UPS. Check whether the output of UPS and loads is short circuited. Make sure the short circuit is removed, and the UPS has no internal faults before turning on again.
Bus short Alarm Code:24	UPS internal fault	Consult your supplier

# Appendix A

## CS141 SNMP card available parameters (valid for CS141 Basic, CS141 ModBus, CS141 Advanced)

The parameters available for CS141 SNMP cards are shown below.

Parameter	Units	Type	Available interface	Modbus register
<b>Measurement Parameters</b>				
Input Voltage	V	Input	Webserver / Modbus	104
Input Frequency	Hz	Input	Webserver / Modbus	111
Output Voltage	V	Output	Webserver / Modbus	97
Output Load Percentage	%	Output	Webserver / Modbus	100
Battery Voltage	V	Battery	Webserver / Modbus	110
Battery Capacity	%	Battery	Webserver / Modbus	103
Temperature	°C	Environmental	Webserver / Modbus	107
<b>UPS Status Information</b>				
On shutdown			Webserver / Modbus	109
On inverter			Webserver / Modbus	109
On battery			Webserver / Modbus	109
<b>UPS Alarms</b>				
Battery Low			Webserver / Modbus	117
Input Bad			Webserver / Modbus	120
On Bypass			Webserver / Modbus	123
General Fault			Webserver / Modbus	132
Test In Progress			Webserver / Modbus	138
Shutdown imminent			Webserver / Modbus	137
Diagnose test failed			Webserver / Modbus	133

# Appendix B

## Winpower SNMP card available parameters (webserver interface)

The parameters available from WinPower SNMP cards are shown below.

Parameter	Type	View
UPS Status	General, status	UPS Monitoring >> UPS Status
UPS Temperature	General, measurement	UPS Monitoring >> UPS Status
Voltage	Input, measurement	UPS Monitoring >> UPS Status
Frequency	Input, measurement	UPS Monitoring >> UPS Status
Load (%)	Output, measurement	UPS Monitoring >> UPS Status
Voltage	Output, measurement	UPS Monitoring >> UPS Status
Frequency	Output, measurement	UPS Monitoring >> UPS Status
Battery Status	Battery, status	UPS Monitoring >> UPS Status
Capacity (%)	Battery, measurement	UPS Monitoring >> UPS Status
Voltage	Battery, measurement	UPS Monitoring >> UPS Status
Time on Battery	Battery, measurement	UPS Monitoring >> UPS Status
Output Rating Voltage	Output, Rating	UPS Monitoring >> UPS Parameters
Output Frequency Rating	Output, Rating	UPS Monitoring >> UPS Parameters
Output Rating VA	Output, Rating	UPS Monitoring >> UPS Parameters
UPS Model	Additional UPS Information	UPS Monitoring >> UPS Identification
UPS Description	Additional UPS Information	UPS Monitoring >> UPS Identification
Firmware Version	Additional Network card Information	UPS Monitoring >> UPS Identification
MAC Address	Additional Network card Information	UPS Monitoring >> UPS Identification

# Appendix C: External Battery Modules (EBM) value calculation

## Introduction

The battery configuration is described in the following way:  
 “number of battery strings” x (“number of 12V battery blocks”  
 x “battery capacity”)

### UPS internal battery configuration

UPS Model	Battery configuration
UPS PowerValue 11 RT 1 kVA B	1 x ( 3 x 7.2Ah )
UPS PowerValue 11 RT 2 kVA B	1 x ( 4 x 9.0Ah )
UPS PowerValue 11 RT 3 kVA B	1 x ( 6 x 9.0Ah )
UPS PowerValue 11 RT 1 kVA S	no internal
UPS PowerValue 11 RT 2 kVA S	no internal
UPS PowerValue 11 RT 3 kVA S	no internal

### External Battery Module (EBM) battery configuration

EBM	Battery configuration
UPS PowerValue 11 RT 1 kVA B	2 x ( 3 x 7.2Ah )
UPS PowerValue 11 RT 2 kVA B	2 x ( 4 x 7.2Ah )
UPS PowerValue 11 RT 3 kVA B	2 x ( 6 x 7.2Ah )
UPS PowerValue 11 RT 1 kVA S	2 x ( 3 x 7.2Ah )
UPS PowerValue 11 RT 2 kVA S	2 x ( 4 x 7.2Ah )
UPS PowerValue 11 RT 3 kVA S	2 x ( 6 x 7.2Ah )

### Standard EBM value setting through LCD display and RS232

(M is the total nr of standard EBM connected,  $1 \leq M \leq 9$ )

UPS Model	LCD display (path: Settings → Password (USER) → External battery modules)	RS232 (command: SASV03[value]<cr>)
UPS PowerValue 11 RT 1 kVA B	M	2M + 1
UPS PowerValue 11 RT 1 kVA S	M	2M
UPS PowerValue 11 RT 2 kVA B	M	2M+1
UPS PowerValue 11 RT 2 kVA S	M	2M
UPS PowerValue 11 RT 3 kVA B	M	2M+1
UPS PowerValue 11 RT 3 kVA S	M	2M

Settings with a customized battery pack of N Ah capacity,  
 through LCD display and RS232 (take only the integer part)

UPS Model	LCD display (path: Settings → Password (USER) → External battery modules)	RS232 (command: SASV03[value]<cr>)
UPS PowerValue 11 RT 1 kVA B	$N/(7.2 \cdot 2)$	$N/7.2 + 1$
UPS PowerValue 11 RT 1 kVA S	$N/(7.2 \cdot 2)$	$N/7.2$
UPS PowerValue 11 RT 2 kVA B	$N/(9 \cdot 2)$	$N/9 + 1$
UPS PowerValue 11 RT 2 kVA S	$N/(9 \cdot 2)$	$N/9$
UPS PowerValue 11 RT 3 kVA B	$N/(9 \cdot 2)$	$N/9 + 1$
UPS PowerValue 11 RT 3 kVA S	$N/(9 \cdot 2)$	$N/9$





# Contact us

[www.abb.com/ups](http://www.abb.com/ups)  
[ups.sales@ch.abb.com](mailto:ups.sales@ch.abb.com)

© Copyright ABB. All rights reserved.  
Specification subjects to change without notice.



614-00797-04

